

Medium Pressure Axial Fans

Model TBI-FS Levels 3, 4 & 5 with Fabricated Steel Propeller

Belt Drive – Inline or Roof-Mounted Upblast

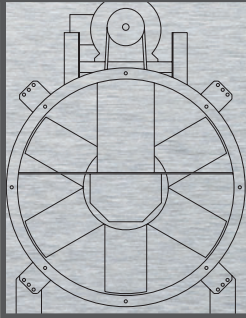

 **GREENHECK**
Building Value in Air.

July
2022

Axial Inline Fans

Model TBI-FS inline fans are the ideal choice for ducted or unducted commercial and industrial ventilation systems. Axial fans can be used for clean, contaminated, or high temperature air ventilation and carry the UL Listing “Power Ventilator for Smoke Control Systems.” The reliable belt drive design allows for on-site performance adjustments and ease of serviceability.

Additional advantages of the TBI-FS:

- Suitable for general ventilation of commercial or industrial facilities such as office buildings, parking garages, warehouses, and manufacturing plants
- Three levels of construction to match the most economical fan with the required application
- Designed for both indoor or outdoor applications
- Includes Greenheck’s “Universal Mounting System” for easy installation

Industrial Duty Propellers

TBI-FS fabricated steel propellers are continuously welded and painted to ensure long life in the harshest commercial or industrial applications. The airfoil blade design and multiple blade pitch options provide efficient selections for low and high pressure applications.

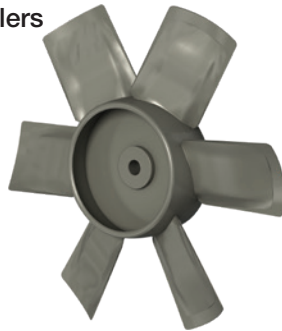



Greenheck certifies that the model TBI-FS tube axial inline fans shown herein are licensed to bear the AMCA seal. The ratings shown are based on tests and procedures performed in accordance with AMCA Publication 211 and Publication 311 and comply with the requirements of the AMCA Certified Ratings Program.



- TBI-FS models are available with UL Listing for Electrical (UL/cUL 705). File no. E40001
- TBI-FS models are available with UL/cUL Power Ventilators for Smoke Control Systems. File no. MH17511

Leading Edge Support

All Greenheck products are supported by the industry’s best product literature, electronic media, and computer aided product selection (CAPS®) program. You’ll also find extensive product and Installation and Operation Manual (IOM) information on our website. To locate your nearest Greenheck representative, visit our website at greenheck.com



Level 3 – Tube Axial

- Maximum pressure capabilities of 1.5 inches wg (370 Pa)
- Volume 5,400 - 54,000 cfm (9,200 - 92,000 m³/hr)
- Most cost effective selections for static pressures below 1.5 inches wg (370 Pa)



Level 4 – Medium Pressure Axial

- Maximum pressure capabilities of 4 inches wg (1,000 Pa)
- Volume 5,800 - 77,000 cfm (9,800 - 131,000 m³/hr)
- Highest efficiencies at static pressures above 1.5 inches wg (370 Pa)
- Heavier gauges suited for industrial applications



Level 5 – Vane Axial

- Maximum pressure capabilities of 4.5 inches wg (1,120 Pa)
- Volume 5,900 - 77,000 cfm (10,000 - 131,000 m³/hr)
- Highest efficiencies at static pressures above 1.5 inches wg (370 Pa)
- Meets Level 4 construction specifications with addition of bolt-on vane section





Electrostatic Powder Paint

All TBI-FS steel housings and propellers are coated with Permator™. Permator is an electrostatically applied polyester urethane powder coating that is excellent for indoor or outdoor applications and also has resistance to many common chemicals.

Greenheck offers a number of proprietary coatings applied via “electrostatic powder”. The standard coating, Permator™, is excellent for indoor or outdoor applications and has resistance to many common chemicals.

Maintenance / Serviceable Construction Advantages

The following features have been incorporated into the design of these fans to allow for quick and easy field service.

- Bearing lubrication is performed through extended grease fittings located on the outside of the fan housing.
- An adjustable motor base is provided for tightening the fan belts.
- Propellers are removed easily with the use of taper lock bushings.

For additional access to the propeller and internal fan components for field service, see the “Easy Access Construction” option in the Accessories section.



Complete Assembly and Testing

TBI-FS fans are completely assembled and tested before shipment. Our inspectors ensure that the fan is vibration free and is electrically safe for field operation.

Easy to Install and Operate

The fan’s compact design helps when fitting into tight spaces. In addition, integral punched flanges or optional Universal Mounting brackets accommodate motor position changes for last minute modifications or unexpected installation obstacles. For information on roof upblast configurations, see page 5.

Model Number Code

The model number code is designed to identify the fan.

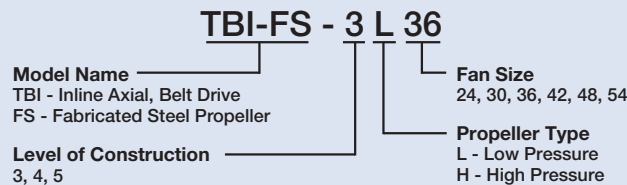

Sound Power versus Sound Pressure

The sound values displayed on the following performance pages are in terms of inlet sound power (L_{w_iA}), or the acoustic power radiating from the inlet of the fan. Sound pressure, expressed as dBA, is the acoustic pressure at a point in space which can be measured with a microphone or can be heard. To convert sound power (L_{wA}) into sound pressure (dBA), the following corrections are typically applied.

Refer to AMCA Publication 303, Application of Sound Power Level Ratings, for additional information on calculating typical sound pressure levels for fan installations.

$$dBA = L_{wA} - \text{Correction}$$

Distance from fan	3 ft (0.9 m)	5 ft (1.5 m)	10 ft (3.0 m)
Correction	7	11.5	17.5

Housing

Housings are continuously welded and painted. The standard coating is Permator™. Stainless steel and aluminum construction available upon request.

Propellers – Airfoil

Propeller hubs and blades are sized to match performance requirements. Reinforced airfoil blades ensure efficient performance selections. Propellers are available in steel or stainless steel.

Inlet & Outlet Flanges

Integral inlet and outlet flanges with mounting holes are provided for airtight ductwork connections.

Bearings

Bearings are air handling quality, grease lubricated, pillow block type. Bearings are selected with a basic rating fatigue life L_{10} in excess of 80,000 hours (equal to average or L_{50} life in excess of 400,000 hours) at each fan's maximum operating speed when mounted in a horizontal configuration.

Belt & Bearing Tube

Belts, bearings, and drives are protected from the airstream by heavy gauge steel belt tubes and bearing covers.

Adjustable Motor Bases

Rigid structural steel motor bases are welded to the fan housing and include heavy-duty adjustment screws for belt tensioning.

Extended Lube Lines

Lubrication lines with grease fittings allow bearing lubrication without disassembling the fan.

Vane Section (Level 5)

Straightening vanes improve efficiencies up to 20% by making the airflow more uniform and less turbulent. Vane section removes to allow access to the fan propeller.



Universal Mounting Accessory

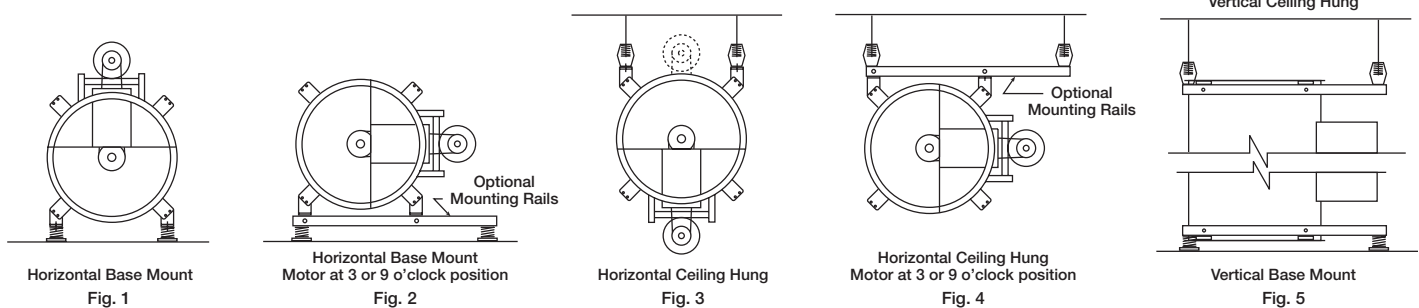

Horizontal and Vertical Mounting Configurations (Brackets Optional)

All fans can be mounted horizontally or vertically. For ease of installation, eight optional mounting brackets can be welded to each fan. These brackets along with mounting supports provide for Greenheck's universal mounting system.

Fig. 1 Horizontal Base Mount

Each fan is shipped as standard in this arrangement. Motor at 12 o'clock is standard.

Fig. 2 Horizontal Base Mount with motor at 3 or 9 o'clock

A set of optional mounting rails are required for this installation. This is the base mounting position required with the easy access option.

Fig. 3 Horizontal Ceiling Hung

In this installation the supports can be positioned for mounting the motor at either 6 or 12 o'clock.

Fig. 4 Horizontal Ceiling Hung with motor at 3 or 9 o'clock

A set of optional mounting rails are required.

Fig. 5 Vertical Mount

All TBI-FS fans can be mounted vertically (ceiling hung or base mount) for either upward or downward airflow. Optional mounting rails are recommended for belt driven fans.

NOTE: All fans are shown with optional mounting brackets and vibration isolators. See the appropriate submittal drawings or installation manual for complete dimensional data.

High Temperature - Emergency Smoke Options - UL/cUL Listed

Model TBI-FS axial fans are designed for high temperature process exhaust or emergency smoke and heat relief. The table to the right lists temperature operation ranges and durations for each temperature.

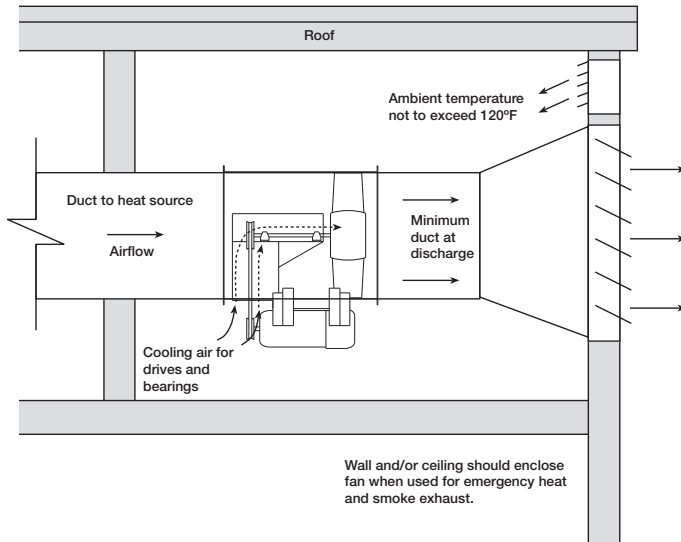

	Operating Temperature		Time Duration
	°F	°C	Hours
Continuous Duty			
Standard Construction	180	82	Continuous
Inline	400	204	Continuous
Roof Upblast	500	260	Continuous
Emergency Smoke Control			
HT-UL • UL/cUL Listed	300	149	5
	750	399	4
	1000	538	0.25

Applications designed for **Continuous Duty** industrial applications include high temperature paint and copper extended lubrication lines.

HT-UL construction meets or exceeds IRI and SBCCI and includes a UL/cUL Listed Power Ventilators for Smoke Control label adhered to the product.



All high temperature options include a minimum of dual groove drives.

For the greatest amount of internal cooling, discharge static pressure should be kept to a minimum while keeping most of the pressure on the inlet side. Locate the fan at ends of the duct runs and near the discharge point in the system. This setup will promote the ambient air cooling effect.

Roof Upblast Construction

The upblast configuration is ideal for exhausting contaminants, smoke or high temperature air away from the building to prevent roof damage and intake air contamination. Additional features include windband, butterfly dampers, curb cap and motor cover. Consult the Greenheck computer aided product selection (CAPS®) program or a Greenheck representative for performance information.

1 Windband with Butterfly Dampers

Windband and butterfly dampers eliminate rain penetration from upblast, roof mounted units when the fan is not in operation. Gasket over raw edge reduces damper noise and helps seal blades when not in use.

2 Curb Cap

Heavy-gauge, welded curb caps provide transition from square roof curb to tubular fan housing.



Universal Mounting Brackets

Universal mounting brackets include all hardware necessary to position the fan horizontally or vertically in either base mount or ceiling hung applications.

Mounting Rails

Mounting rails are recommended for horizontal mounting of TBI-FS fans when the motor is to be located in the 3 or 9 o'clock position or for any vertically mounted applications. Universal mounting brackets are required.



Companion Flanges

Companion inlet flanges and outlet flanges with prepunched holes are available for all fan sizes.

Belt Guard

Belt guards provide protection from rotating pulleys and belts. Belt guards meet OSHA guidelines.

Motor Cover

A weatherproof motor cover shields the motor and drive components from dust, dirt and moisture. Motor cover meets OSHA guidelines.

Inspection Section

Inspection sections are an easily removable length of duct and are recommended to improve serviceability. Inspection sections are provided with a full diameter removable access panel.

Inspection Door

Bolted or hinged, inspection doors provide access through the fan tube for inspection of the propeller, bearings and drives.

Inlet and Outlet Guards

Removable inlet and outlet guards provide protection for personnel and equipment in ducted or non-ducted installations. Guards meet OSHA guidelines.

Inlet Bell with Inlet Guard

Inlet bells minimize entry losses in non-ducted applications by providing more uniform airflow into the propeller blades. Inlet bells are furnished with inlet guards that meet OSHA guidelines.

Isolators

Both base-mount or hanging isolators are available in either neoprene or spring mounts. The isolators are furnished in sets of four and are sized to match the weight of each fan.

UL/cUL 705

UL/cUL 705 Electrical Listing on 50 or 60 Hz motors. Motors are supplied by Greenheck.

Special Coatings

Special coatings are available for protective purposes. Coatings are applied before assembly so that each manufactured component is coated inside and out. Painting the exterior a specified color for appearance is also an option.

Disconnect Switches

Toggle type and heavy-duty disconnect switches are available for positive electrical shutoff and safety in servicing fans. Switches can be factory mounted or shipped loose for field mounting.



- NEMA-1 – General purpose
- NEMA-3R – Rainproof
- NEMA-4 – Watertight
- NEMA-7 and 9 – Class 1 and Class 2 hazardous locations.

Greenheck will not factory mount NEMA-7 and 9 disconnect switches.

Motor Starters

The fundamental function of a motor starter is to protect the motor from damage that can occur from overheating. With a Greenheck motor starter you will be provided with the best motor protection available.



Specific model components may include SmartStart™ technology, physical interface, overload protection, disconnect, magnetic contactor, NEMA-1 or NEMA-3R steel enclosures and pre-engineered easy system integration. For complete information on specific Greenheck Motor Starter models, refer to the motor starter page found on greenheck.com.

Easy Access Construction

The Easy Access option is highly recommended to provide inspection, cleaning, and service of internal fan components. This option allows for the removal of the fan shaft and bearings through the housing without removing the fan from the duct. For service or removal of the propeller, the inspection section with removable access panel is recommended.



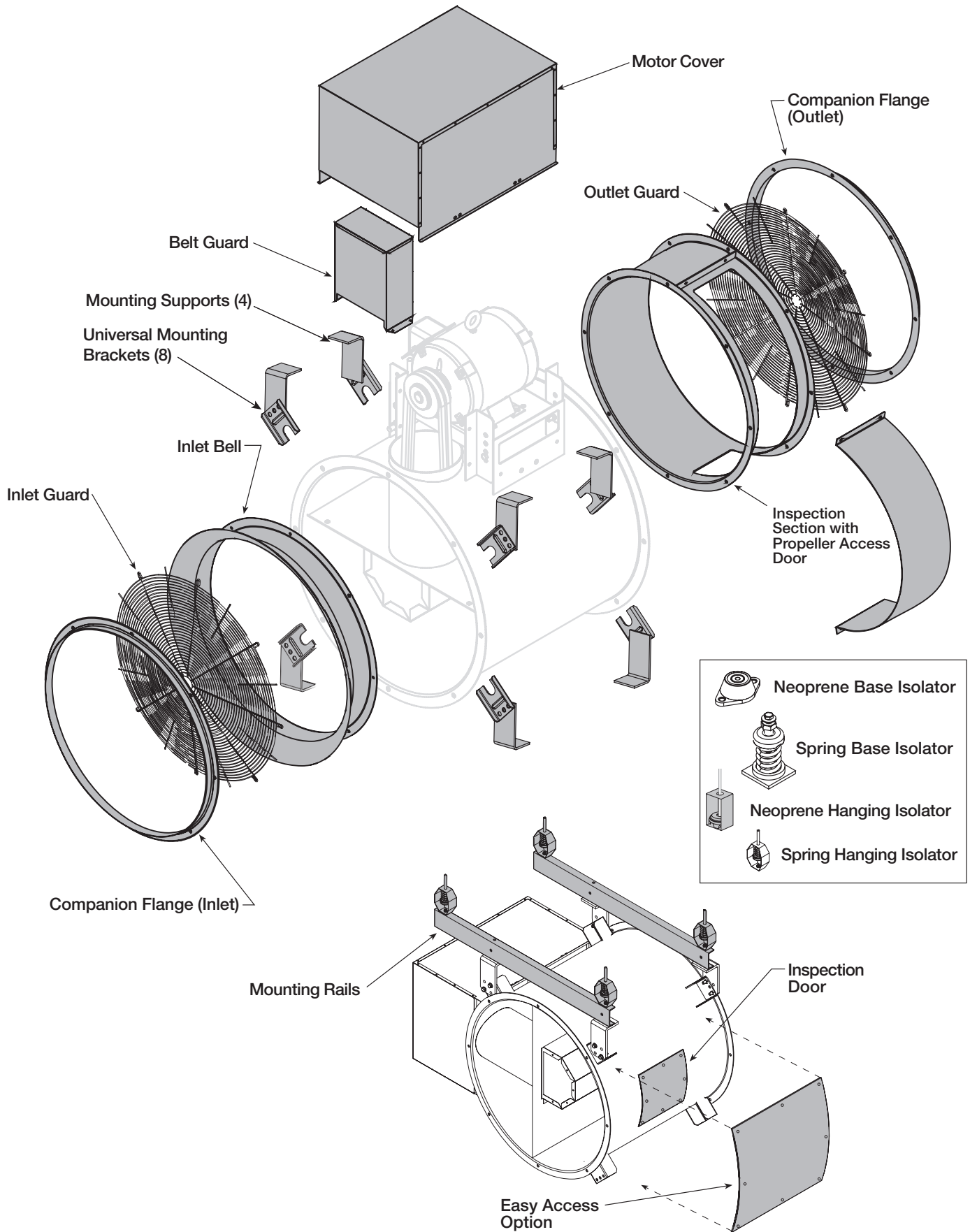

Model TBI-FS Axial Inline – Belt Drive

Inline fans shall be of the axial type with fabricated steel airfoil propellers.

The housing shall be constructed of continuously welded steel to assure no air leakage and include integral punched inlet and outlet flanges. The housing, bearing support, and motor base shall be constructed of structural members to prevent vibration and rigidly support the shaft, bearings, and motor.

Steel housings, propellers, and structural components to be coated with Permator™, an electrostatically applied thermosetting polyester urethane. Minimum thickness to be 1.5 to 2 mils.

Propeller blades shall be airfoil design. Blade gussets shall be die formed and welded to the blade stem. Propellers to be statically and dynamically balanced to G6.3. A standard square key or tapered bushing shall lock the rotor to the fan shaft.

Bearings shall be cast iron pillow block, grease lubricated and self-aligning. Bearings shall be air handling quality and tested for reduced swivel torque, bore size, noise, and vibration. Bearings shall be selected for an L₁₀ life in excess of 80,000 hours for horizontal applications or an L₁₀ life of 40,000 hours for vertical applications.

Turned, precision ground and polished steel shafts shall be sized so the first critical speed is at least 125% of the maximum operating speed for each level of construction.

TBI-FS fans shall be licensed to bear the AMCA Seal for Sound and Air Performance and be Listed for UL 705 Power Ventilators. Emergency smoke fans shall be UL/cUL Listed “Power Ventilators for Smoke Control Systems.”

Fans shall be model TBI-FS as manufactured by Greenheck of Schofield, Wisconsin, USA.

Additional Level 5 Specification

Provided with removable straightening vane section fastened to outlet flange. Vanes shall be welded to inner diameter of bolt-on section. Minimum of seven blades constructed of 10 gauge material or greater.

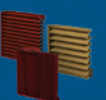
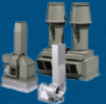

Building Value in Air

Greenheck delivers value to mechanical engineers by helping them solve virtually any air quality challenges their clients face with a comprehensive selection of

top quality, innovative air-related equipment. We offer extra value to contractors by providing easy-to-install, competitively priced, reliable products that arrive on time.

And building owners and occupants value the energy efficiency, low maintenance and quiet dependable operation they experience long after the construction project ends.

Our Commitment

As a result of our commitment to continuous improvement, Greenheck reserves the right to change specifications without notice.

Product warranties can be found online at Greenheck.com, either on the specific product page or in the literature section of the website at Greenheck.com/Resources/Library/Literature.

