

Installation, Operation and Maintenance Manual

Please read and save these instructions for future reference. Read carefully before attempting to assemble, install, operate or maintain the product described. Protect yourself and others by observing all safety information. Failure to comply with these instructions will result in voiding of the product warranty and may result in personal injury and/or property damage.

These instructions apply to zero clearance installation of electric duct heaters within ducts. They are approved for use with heat pumps, air conditioners, or other forced air systems and may be controlled by contactors, relays, sequencers, or solid state devices.

Greenheck duct heaters are pre-wired, factory tested, and furnished with integral controls.



Table of Contents

General Information	1
Electrical Guidelines	2
Minimum Air Velocities.	2-3
Installation	4-5
Insulated Duct Installation	6
Installation Details with SSR Controllers.	7
Installation Details for Staged Heaters.	8
Thermostat Connection Information.	9-10
Troubleshooting Guide.	11-12

General Information

IDHB and IDHE series are intended for installation in accordance with electric heaters requirements established by:

- National Fire Protection Association
- NFPA Standards 90A and 90B
- NFPA Standard 70

“UL Listed (see complete marking on product)
ANSI/UL Standard 1996 (File E366239)

Installation Supplements

Refer to the appropriate Greenheck installation supplements for special requirements (www.greenheck.com links are underline):

- [IDHE-O Outdoor Applications](#)
- [T725 Thermostat Installation Instructions](#)
- [T725 Thermostat Operation Instructions](#)
- [T855 Thermostat Installation Instructions](#)
- [T855 Thermostat Operation Instructions](#)

Online version to this Installation instructions at www.greenheck.com.

[IDHB and IDHE
Duct Heaters](#)



Receiving and Handling

Upon receiving heater, check for both obvious and hidden damage. Check all insulators for breakage and inspect heater element wire(s) for any deformation or damage that could cause a short circuit to ground. Make sure all fasteners are tight. Electrical connections such as pressure terminals should be checked for tightness. If damage is found, record all necessary information on the bill of lading and file a claim with the final carrier. Check to be sure that all parts of the shipment, including accessories, are accounted for.

Heaters must be kept dry and clean. Indoor storage and protection from dirt, dust and the weather is highly recommended. Do not store at temperatures in excess of 100°F (38°C).

Safety Warning

Improper installation, adjustment, alteration, service or maintenance can cause property damage, injury or death. Read the installation, operating, and maintenance instructions thoroughly before installing or servicing this equipment.

This manual is the property of the owner and is required for future maintenance. Please leave it with the owner when the job is complete.

Electrical Requirements

Refer to the wiring diagram on inside of cover. Make sure line and control voltage of system matches that noted on wiring diagram.

Wire in accordance with N.E.C. and any existing local codes. Check tightness of all factory and field electrical connections. Make sure fan interlock is wired in if the Duct Heater does not have an air flow switch.

Use 90°C (194°F) copper wire.

Control must be wired for N.E.C. Class 1 unless otherwise specified.

When heater has integral transformer for control voltage to thermostat, use thermostat with isolating contacts to prevent interconnection of Class 2 outputs.

Disconnect **all** electrical power before servicing. When servicing heater, make sure all components are repositioned in the proper location and reconnected per the wiring diagram.

Replacement parts must be identical to the original components. Contact factory for replacement parts.

Minimum Air Velocities

The minimum uniform airflow in a duct heater is directly related to the inlet air temperature. Consideration must be given to both airflow across the heater and inlet air temperature, (shown at right).

- To calculate the watts per sq. ft. of duct area, divide the total watts required by the duct area.

EXAMPLE: Duct Size = 2ft. x 3ft.

Total watts = 20,000

W/Sq. Ft. = $\frac{20,000}{6} = 3333$

- If the air handler equipment is expressed in fpm, then a direct cross reference can be made by comparing the temperature of the air (as it enters the Duct Heater) to the kW rating on the chart of rated velocity.
 - Draw a line horizontally from the Watts/Sq. Ft. required to the inlet air temperature being used.
 - From this point of intersection on the Inlet Air Curve, draw a line down vertically to establish the air velocity.
 - The velocity should never be lower than the velocity as determined from the chart. In cases where this is not true, the velocity must be increased or the kW required must be reduced.
- In cases where the air handling equipment is expressed in CFM, convert to FPM by dividing the CFM by the duct area.

EXAMPLE: $FPM = \frac{CFM}{Duct\ Area}$

Note: Minimum airflow must be maintained at any point over the face of the heater. The velocity of air should NEVER be lower than the specified minimum. In cases where this is not true the KW must be reduced or the velocity of air increased.

Note: Observe at least one complete heating cycle to insure that cycling of the safety limit controls does not occur before leaving the installation.

IDHB: Minimum Air Velocity

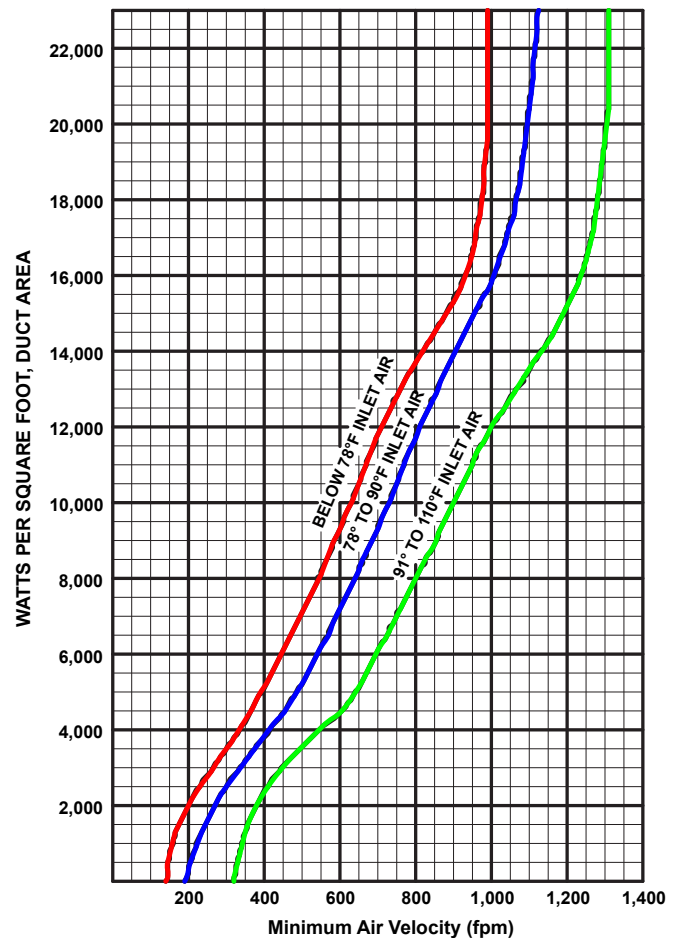

IDHE: Air Flow Requirements

Minimum Air Velocity: See charts below

Maximum Inlet Air Temp: 110°F

Maximum Heater KW: 30 KW per Square Foot of Duct Cross Section

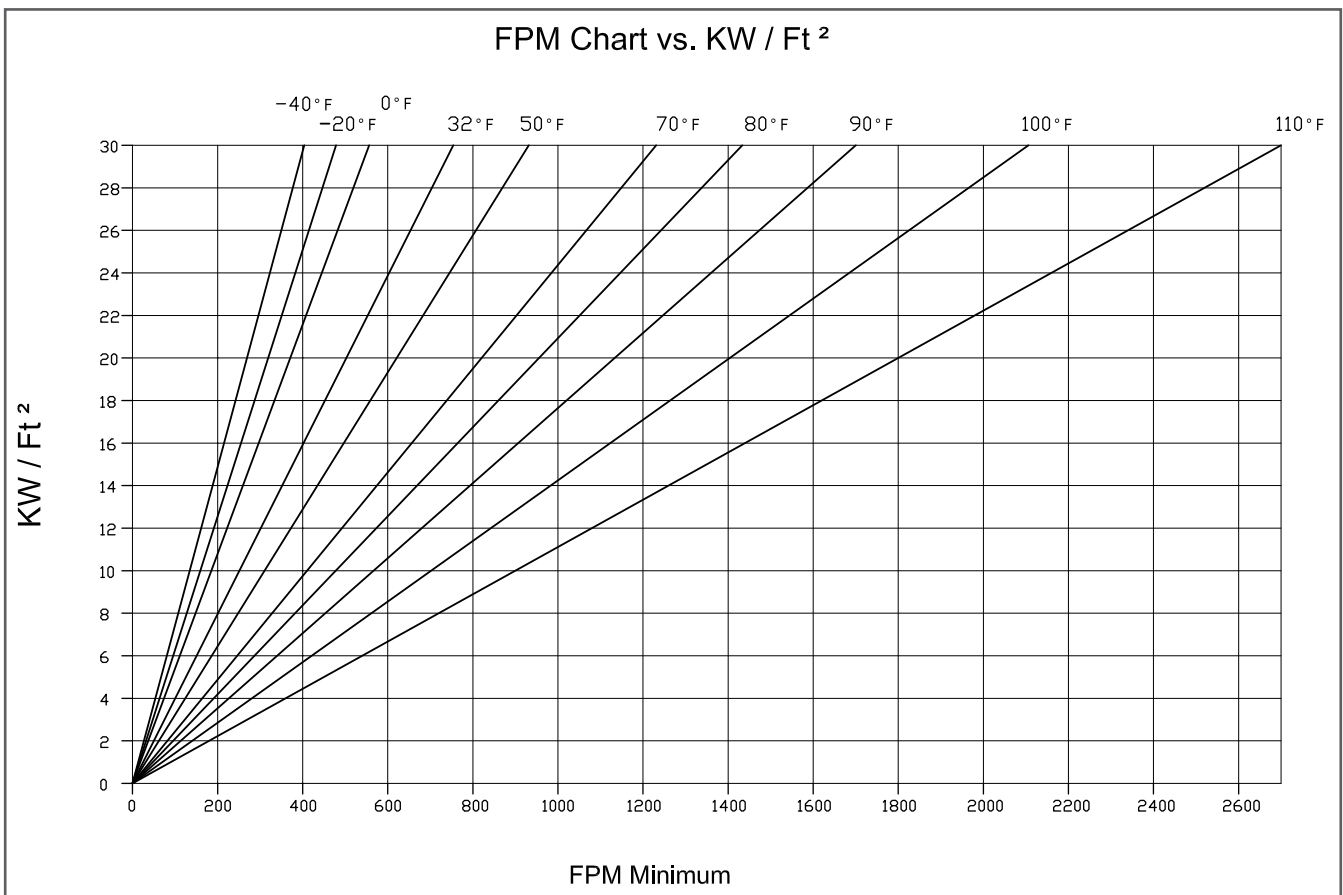
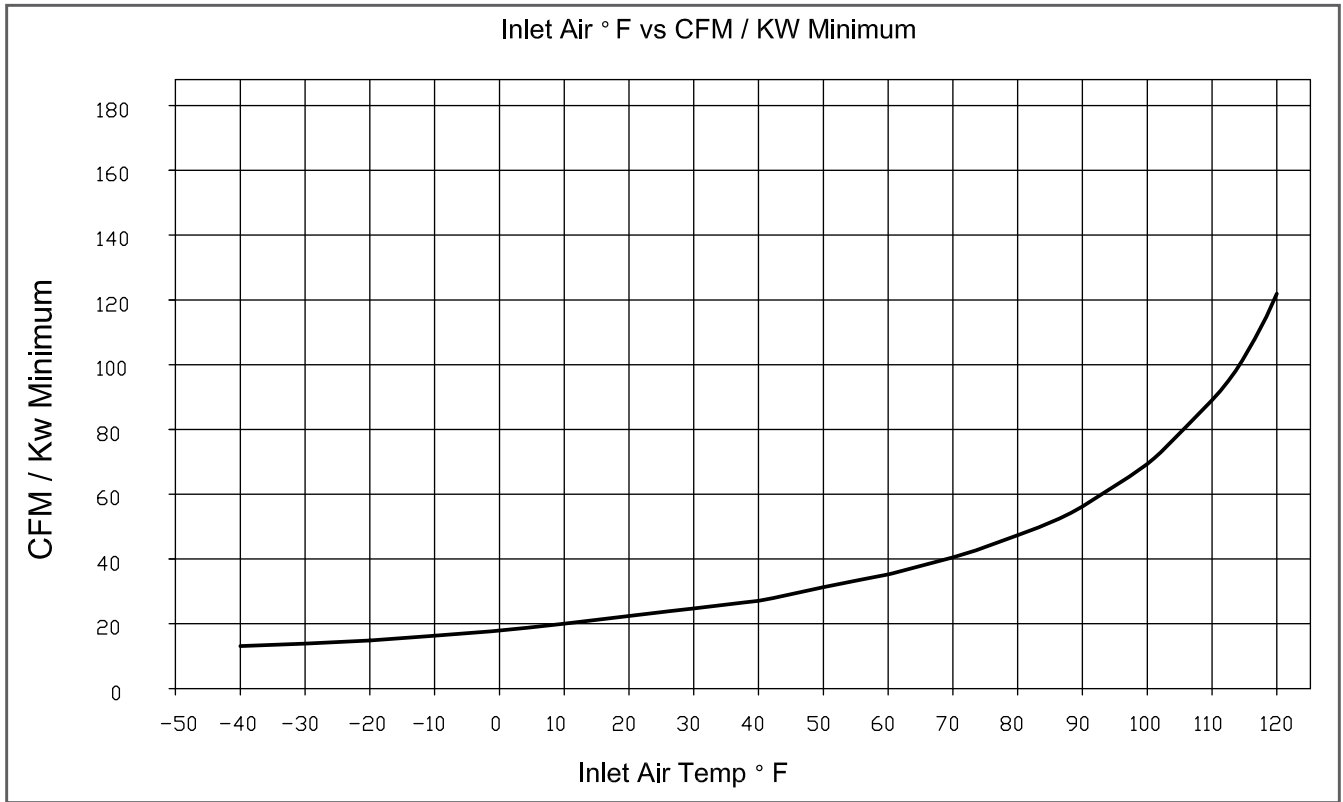

Installation

Failure to follow instructions will void all warranties. For safe operation and best performance, the following installation procedures must be adhered to.

Note: Do not “Bank “ heaters (side by side). If greater capacity is required, proportion smaller heaters in separate runouts. Heater control boxes must be completely accessible and located to provide ventilation at all times.

Duct Orientation

Heaters may be installed in the vertical sides of horizontal or vertical ducts but never in the top or bottom of a horizontal duct. Heaters are approved for airflow in both directions when installed in horizontal duct.

IDHB: Heaters installed in vertical ducts are tested and approved for up airflow only!

IDHE: Heaters installed in vertical ducts are tested and approved for up and down airflow.

1. Install heater a minimum of four feet:
 - From heat pumps or central air conditioner
 - Downstream from an air handler
 - From any canvas duct connector or transition in duct size
 - Downstream from an air filter
 - Upstream from a humidifier
2. At least 2 feet either side of an elbow or turn.

Control Cabinet Orientation

IDHB: The control cabinet must be positioned as labeled on the unit.

IDHE: The control cabinet offset may be positioned in either direction as chosen by the installer.

Slip-in Heater: To install a slip-in heater (**Figure 1**), cut an opening as required in the side of the duct. Slide heater in the duct using the control box as template to mark the mounting screw holes. Remove unit and drill mounting holes. Mount unit to duct with sheet metal screws. Connect high and low voltage supplies along with fan interlock circuit (if no airflow switch is furnished). Larger heaters may require hangers. Connect high and low voltage supplies as required.

Flange Heater: To install a flange type heater (**Figure 2**), insert heater between two sections of flanged duct, and bolt in place. For additional strength, the duct flange should be doubled as shown in the figure. Large heaters may require hanger straps. Connect high and low voltage supplies along with fan interlock circuit (if no airflow switch is furnished).

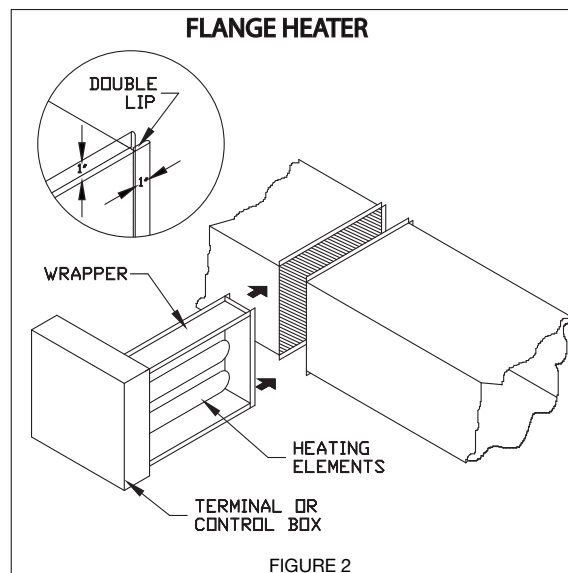
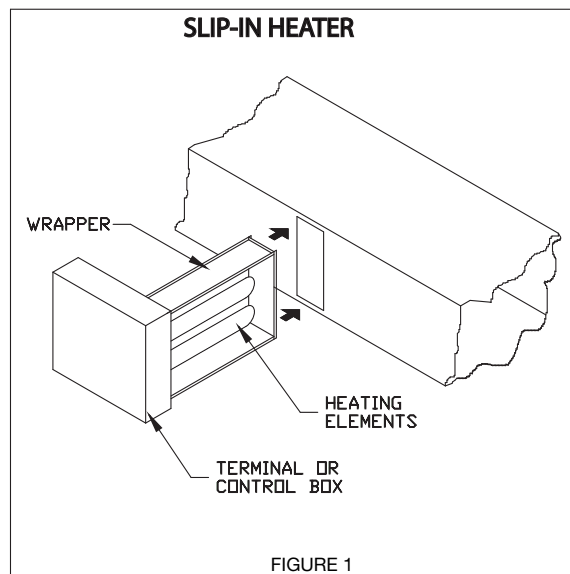

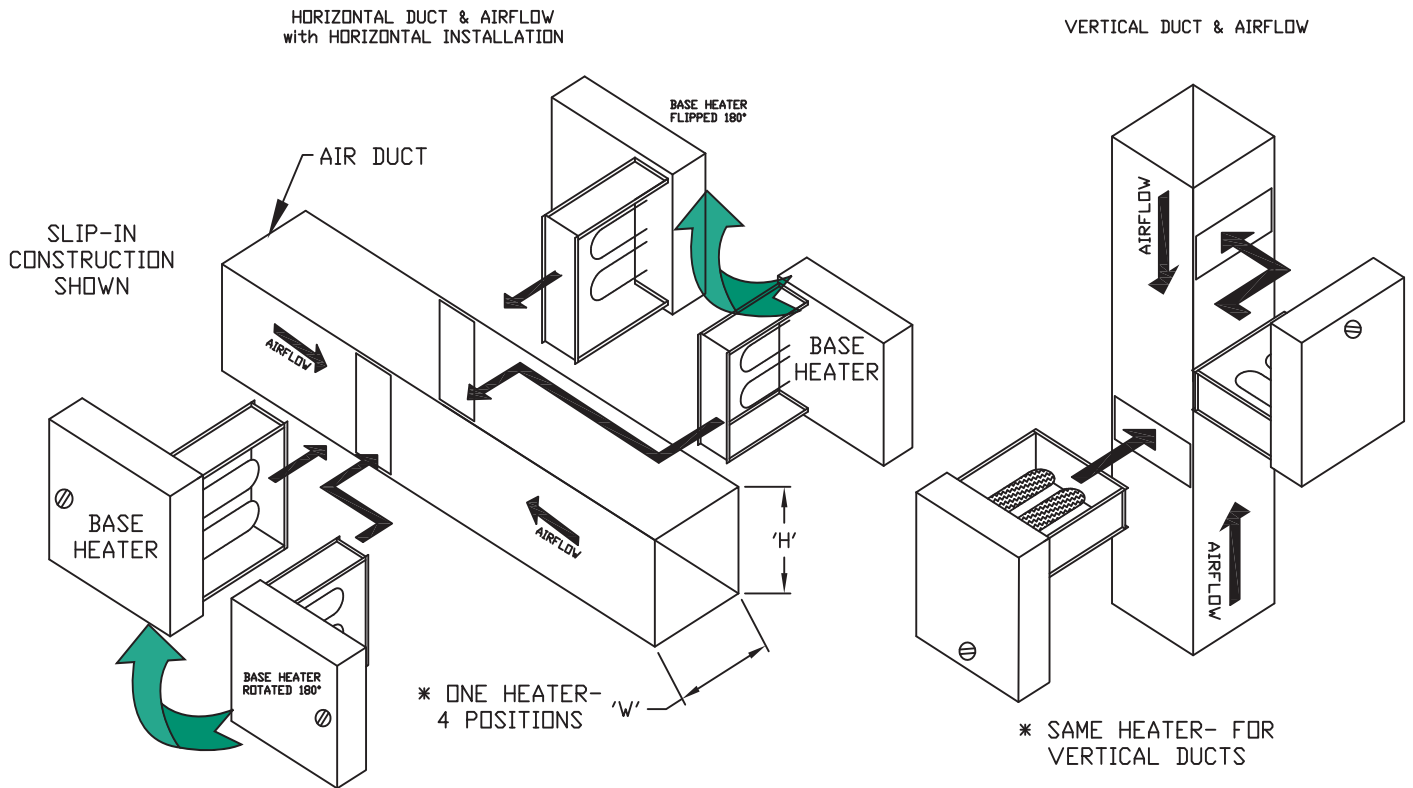

Figure 3: IDHE orientation

Airflow Switch: When furnished, ensure the airflow switch is plumbed appropriately for the given duct condition. The pickup tube must be connected to the switch port labeled “LOW” if the duct is negatively pressurized and the opposite port if positively pressurized.

Note: An airflow switch only proves that airflow exists (a differential in static pressure), not that the minimum air velocities and proper air distribution for the duct heater exist.

Insulated Duct Installations

Duct with External Insulation

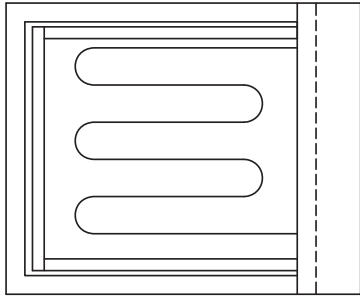

END VIEW

NOT TO SCALE

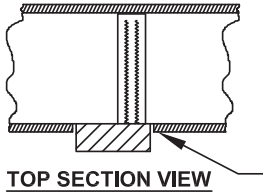

TOP SECTION VIEW

The external insulation is to be removed from the area where the heater is mounted.

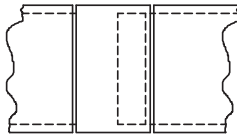

FRONT VIEW

Note: Size of heater is based on the duct size (no recess required).

Duct with Internal Insulation

S-type with internal insulation left in place or duct constructed from insulation board

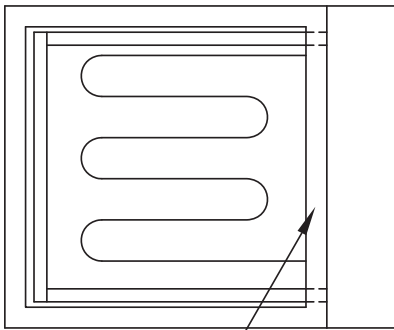

Recess = Insulation Thickness

END VIEW

NOT TO SCALE

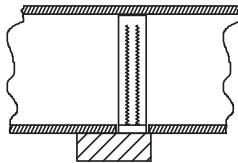

TOP SECTION VIEW

Note: Size of heater is based on the following:
 Heater 'H' = Duct 'H' - (Insulation Thickness x 2)
 Heater 'W' = Duct 'W' - Insulation Thickness (recess required)

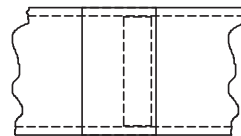

FRONT VIEW

Internal insulation cut away

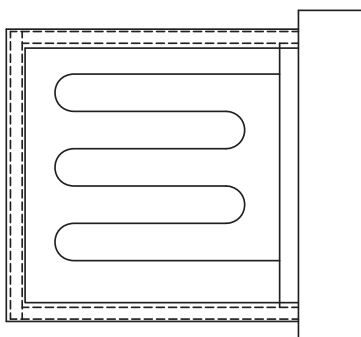

END VIEW

NOT TO SCALE

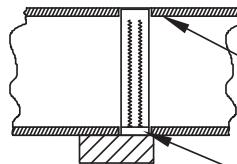

TOP SECTION VIEW

The internal insulation is to be removed from the area where the heater is mounted

Recess = Insulation Thickness

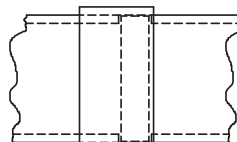

FRONT VIEW

Note: Size of heater is based on the duct size (recess required).

Installation Details for Electric Duct Heaters Equipped with SSR's (including SSR Vernier Control)

SSR controlled heaters will need to be supplied with a 0 to 10 VDC, 2 to 10 VDC, or a 4 to 20 mA signal generated from the building's automation system or a local thermostat.

The configuration dipswitch is used for setting up the common input type. Using a pen point, gently push the switch up for on and down for off according to the setup outlined in the table below.

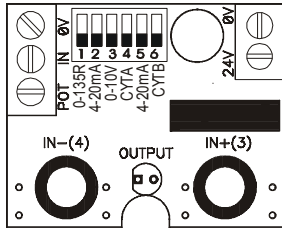

Command Input	1	2	3	5
0-10V	OFF	OFF	ON	OFF
4-20mA	OFF	ON	OFF	ON
2-10V	OFF	OFF	ON	ON

INTERFACE MODULE CONTROL SIGNAL WIRING CONNECTION DIAGRAM

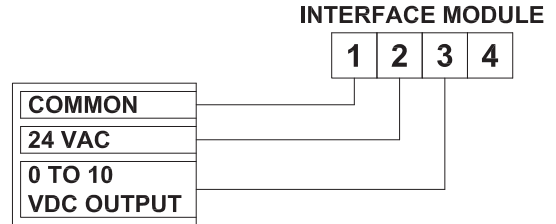

2 TO 10 VDC STAND ALONE THERMOSTAT

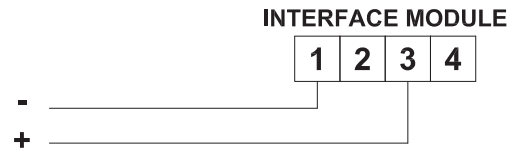

2 TO 10 VDC FROM D.D.C. BUILDING AUTOMATION SYSTEM

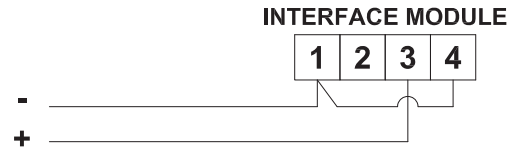

4 TO 20 mA FROM D.D.C. BUILDING AUTOMATION SYSTEM

Installation Details for Staged Electric Duct Heaters

For Standard Non-SSR Heater only!

CONTROL FOR HEATERS WITHOUT INTERNAL TRANSFORMER (REQUIRES 24 VAC)*

THESE HEATERS WILL REQUIRE A THERMOSTAT THAT CAN PROVIDE A 24 VAC* SIGNAL TO CONTROL THE HEATER STAGING.

THERMOSTAT

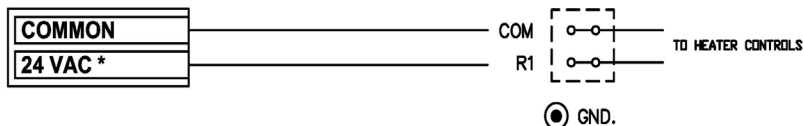

CONTROL FOR HEATERS WITH INTERNAL TRANSFORMER *

THE HEATER'S TRANSFORMER CAN POWER ALL OF ITS OWN CONTROLS. A DRY CONTACT THAT CONNECTS COMMON TO R1, R2, ETC. IS ALL THAT IS REQUIRED TO TURN THIS TYPE OF HEATER ON/OFF.

INTERNAL TRANSFORMER CAN BE USED TO POWER THE THERMOSTAT IF NEEDED

NOTE: BE CAREFUL NOT TO OVERLOAD TRANSFORMER WITH THINGS SUCH AS EXTERNAL LOADS, EXTRA LONG CONTROL WIRES, ETC.. AN EXTERNAL TRANSFORMER MAY BE REQUIRED IN THESE SCENARIOS.

THERMOSTAT

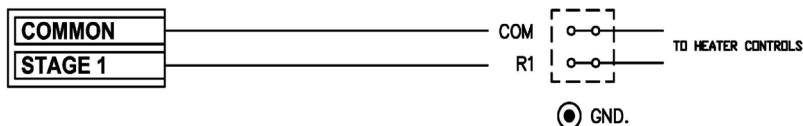

OPTIONAL FAN INTERLOCK ACCESSORY

THE TYPICAL FAN INTERLOCK IS A SET OF DRY CONTACTS TO OPERATE A FAN OR OTHER EXTERNAL DEVICE FOR HEATER OPERATION "CONTACTS CLOSE WHEN HEATER IS ACTIVE"

NOTE: OTHER FUNCTIONS ARE AVAILABLE UPON REQUEST.

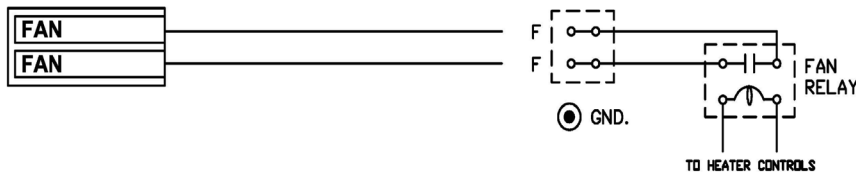

STAGED HEATER HOOKUP

T855

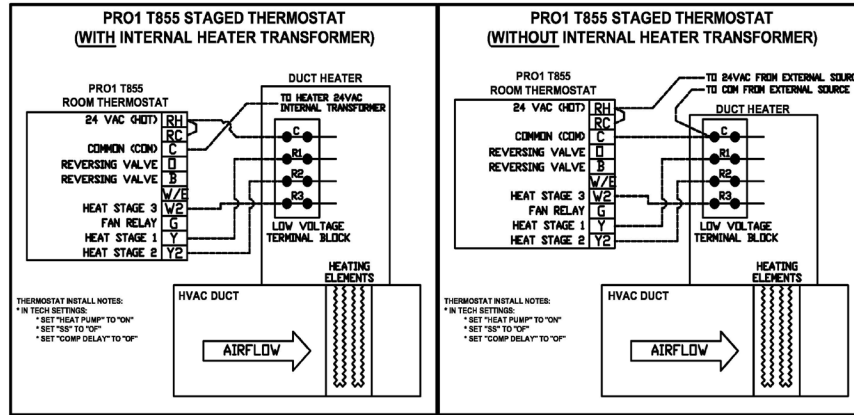

T725

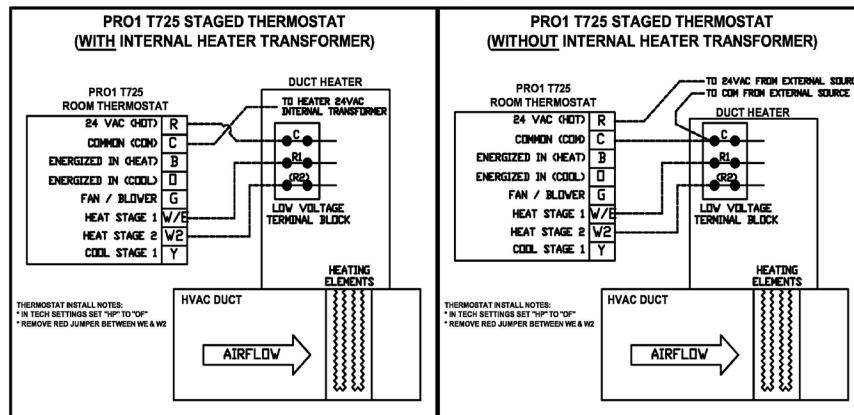

VT7200C

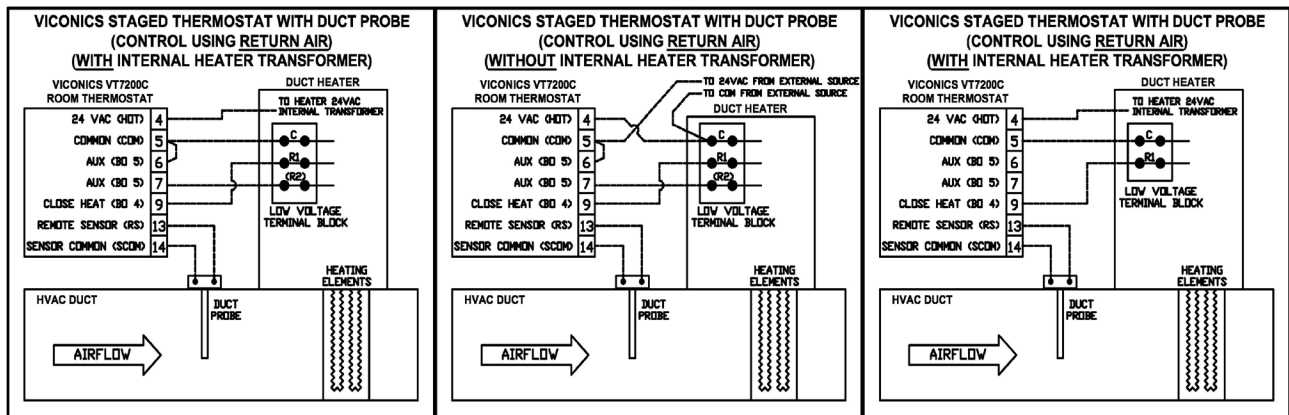

SCR HEATER HOOKUP

VT7225

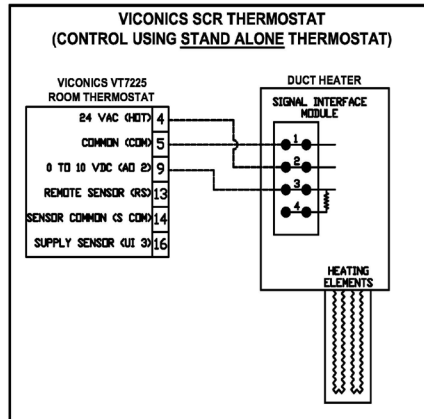

VT7225

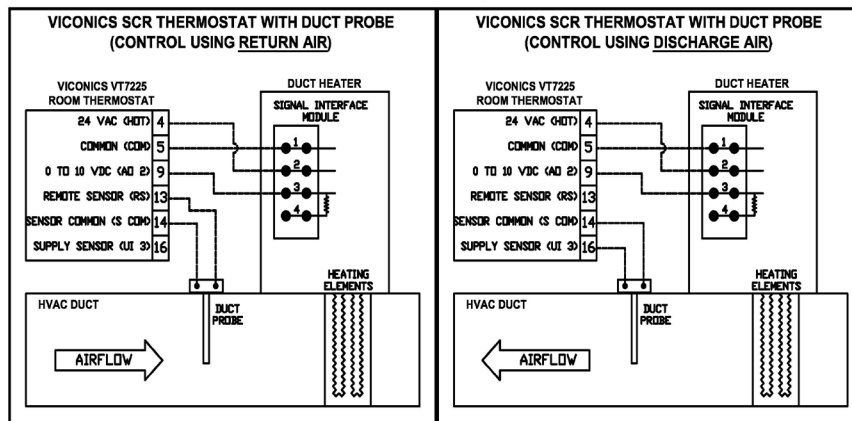

Troubleshooting Guide

A duct heater must be installed according to the installations instructions, wiring diagram and labeling supplied with the heater.

Listed below are some important items when installing an electric duct heater:

1. Never operate a duct heater without airflow. The heater must always be interlocked with the fan. This may be accomplished by either an airflow switch or fan interlock relay.
2. Never operate heater without achieving at least the minimum airflow required. Always refer to the installation instructions and the nameplate label to determine minimum air velocities based on inlet air temperature. If the minimum airflow requirements are not present the heater will not function properly and safely (see **Figure 4**).
3. Never operate the heater with uneven airflow. The minimum airflow requirements must be present at all points over the heater face (see **Figure 4**).
4. The air must be filtered. The incoming air must be free from all debris, combustible particles, and hazardous vapors.
5. Locate the heater at least 24 in. from an elbow or turn (see **Figure 5**).
6. Locate the heater at least 48 in. from the following (see **Figures 6-10**):
 - heat pump or central air
 - canvas duct connector or transition section for change in duct size.
 - downstream from an air handler.
 - upstream from a humidifier
 - downstream from an air filter
 - fan
7. Never install a standard heater into a duct with an internal obstruction. An obstruction can block airflow at the temperature limit controls and element terminations. If this situation exists, it can be corrected by using a heater with recessed control box and reduced wrapper size. This situation is common with internally insulated ducts (see **Figure 11**).
8. Never insulate the exterior of the control box. The control must be completely accessible and located where ventilation can be provided at all times (see **Figure 12**).
9. Never install a heater near a double blower outlet. A heater must be installed far enough away from a double blower outlet so that even and proper airflow is present or separate duct heaters placed in the duct runouts of each blower (see **Figure 13**).

10. Never use aluminum conductors. Use copper conductors only for all incoming wiring.
11. Never install a standard heater outdoors without making special provisions to protect the heater and control box from the elements.
12. Never bundle, tie or wrap power wiring. The wire could overheat or the insulation could breakdown.
13. Never use a different voltage and/or phase than what is listed on the heater nameplate label. The duct heater is to be used only at the voltage and phase that is listed on the nameplate label.

Note: An airflow switch only proves that airflow exists (a differential in static pressure), not that the minimum air velocities and proper air distribution for the duct heater exist.

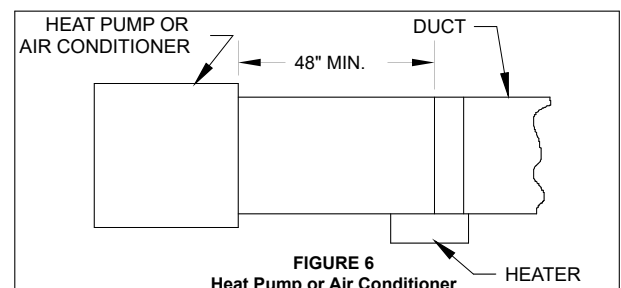
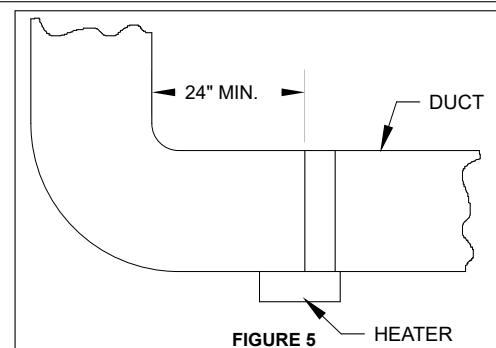
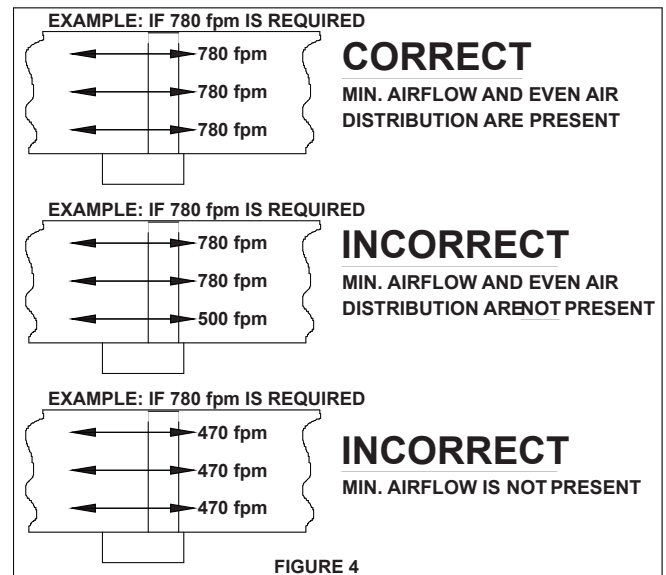

Troubleshooting Guide cont....

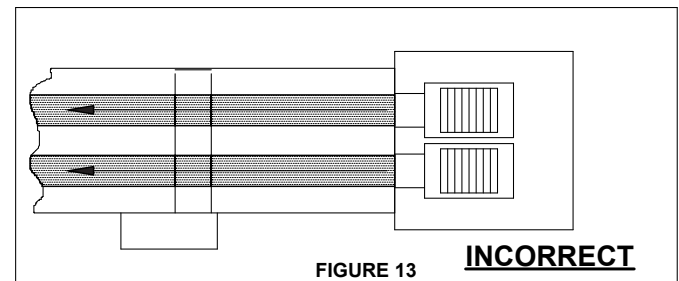
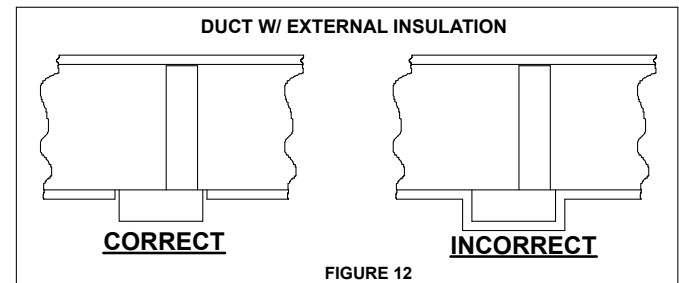
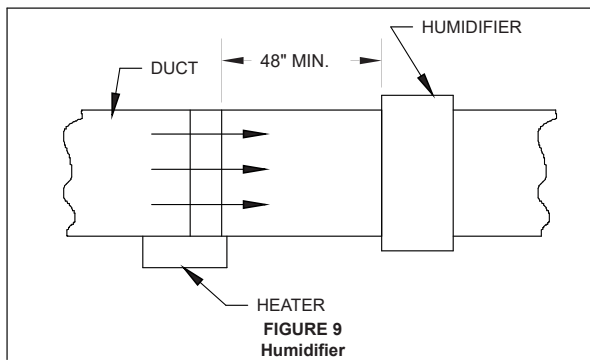
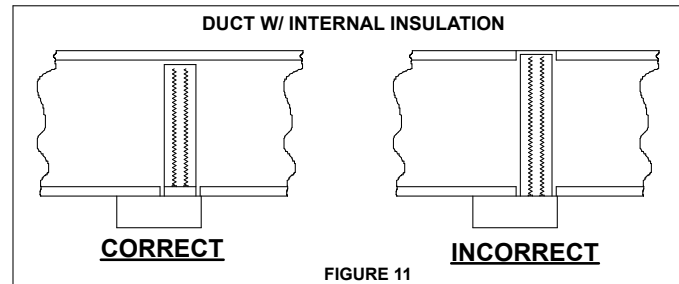
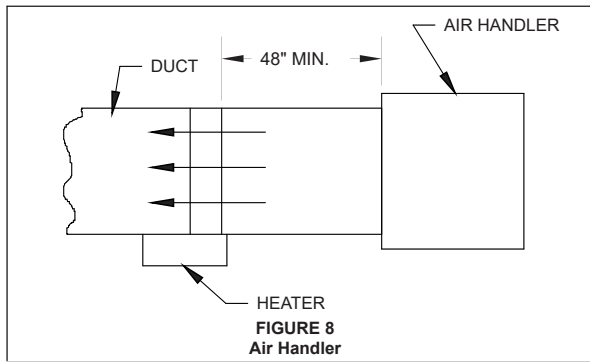
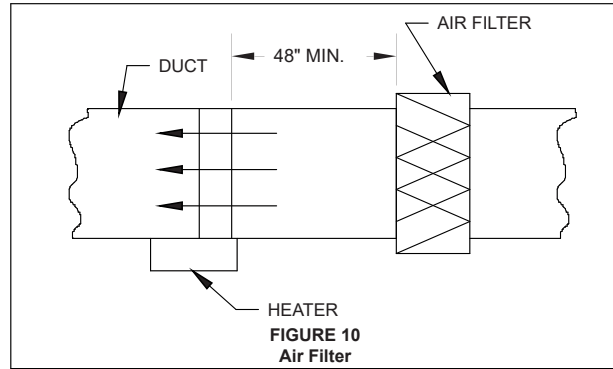
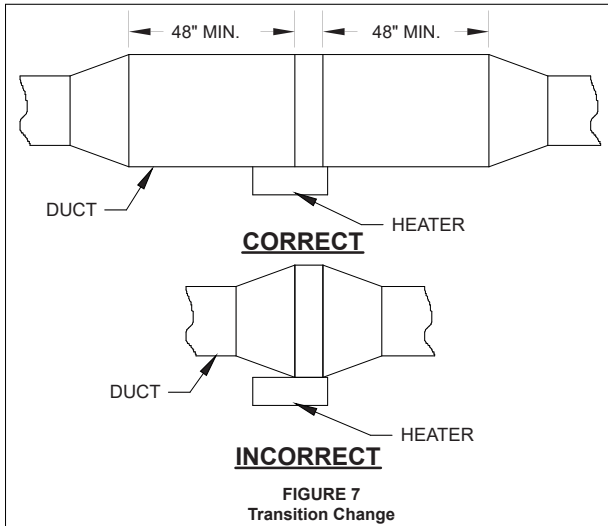

Our Commitment

As a result of our commitment to continuous improvement, Greenheck reserves the right to change specifications without notice.

Product warranties can be found online at Greenheck.com, either on the specific product page or in the literature section of the website at Greenheck.com/Resources/Library/Literature.

