

Installation, Operation and Maintenance Manual

Please read and save these instructions for future reference. Read carefully before attempting to assemble, install, operate or maintain the product described. Protect yourself and others by observing all safety information. Failure to comply with these instructions will result in voiding of the product warranty and may result in personal injury and/or property damage.



General Safety Information

Only qualified personal should install this product. Personnel should have a clear understanding of these instructions and should be aware of general safety precautions. Improper installation can result in electric shock and other potential hazards.

1. Follow all local electrical and safety codes, as well as the National Electrical Code (NEC) and latest edition of the National Fire Protection Agency Standard for Ventilation Control and Fire Protection of Commercial Cooking Operations (NFPA 96). Follow the Canadian Electrical Code (CEC) and ULC-S650 if installing this product in Canada.
2. Do not allow the electrical components of this product to come in contact with oil, grease, hot surfaces, water, or chemicals.
3. Verify the site can supply the necessary power for each fan and for the control panel.

WARNING

Electrical shock hazard. Can cause equipment damage, personal injury or death. Service must only be performed by personal that are knowledgeable in the operation of the equipment being controlled.

CAUTION

Always disconnect power before working on or near the product. Lock and tag the disconnect switch or breaker to prevent accidental power up.

CAUTION

It is the responsibility of the installer to make sure both electrical and gas appliances shut down in the event of a fire or in the event of a power loss to the building when this sequence is required by the authority having jurisdiction.

Table of Contents

General Description	2
Receiving and Handling	2
Installation	
Control Box	3
Switch Mounting	3
Temperature Sensor(s) - Hood Mounting	3-4
Duct Collar Mounting	4
Thermostat - Hood Mounting	4
Duct Collar Mounting	5
Electrical Connections	
Power for KFCC	6
Power for Hood Lights	6
Power for Starters and Fans	7
Fire System Integration	7
Spare Fire Contacts	8
Switches - Fan, 1-Speed	8
Fan, 2-Speed	8
Lights	8
Tempered Supply, Heat Only	9
Tempered Supply, Cool Only	9
Tempered Supply, Heat and Cool	9
Combination Fan/Light Switch	9
Make-Up Air Interface	9
Power for Shunt Trip	9
Audible Alarm	9
Lights Out in Fire	10
Additional Fire Contacts	10
Additional Exhaust Contacts	10
Additional Supply Contacts	11
Exhaust Fan Failure Indicator	11
Supply Fan Failure Indicator	11
Status Lights	11
Temperature Interlock, Digital	12
Temperature Interlock, Thermostat	12
Digital Temperature Interlock Configuration	13-14
Thermostat Style Temperature	
Interlock Configuration	15
KFCC Field Connection Checklist	16
General Wiring Diagram	17
Testing	18
Operation	19
Troubleshooting	19
Maintenance	20
Frequently Asked Questions	20
Replacement Parts	21
Codes and Standards	21
Maintenance Log	22-23
Our Commitment	24

General Description

Description

The kitchen fan control center, or KFCC, is a pre-engineered package designed to control the operation of fans in a constant volume kitchen. The package consists of a cabinet encasing one or more fan motor starters interlocked together for on/off operation. Different fan, light and thermal switch combinations may be provided to operate the kitchen hood fan(s), light(s), and heating/cooling capabilities of the supply air. The control center as a standard is equipped with additional relays prewired to the fan starter(s). These additional relays are capable of turning on the kitchen exhaust and shutting down supply regardless of the present state of the fans via integration of a fire system microswitch with factory terminals. The control center can be equipped with temperature interlock, designed to automatically start kitchen fans and keep them running while heat is being generated from the cooking appliances. Hood systems should always be manually started before the cooking equipment is turned on, but if forgotten the interlock will safely trigger the fans to start once heat is detected. Other options are available.

Purpose

The purpose of the KFCC is to provide a complete control center equipped with fan motor starters. The control center provides a common connection point to interlock kitchen exhaust, supply, and hood lights with the hood's fire suppression system. The cabinet is pre-engineered with terminal blocks for most field wiring connections. The control center can also be equipped with interlock between the exhaust fans and cooking equipment, as to meet International Mechanical Code (IMC) 2015 Section 507.1.1. In this case, the system will utilize a temperature sensor in the exhaust duct collar or capture area in the hood to detect heat generated from cooking operations and automatically activate the exhaust fans if not already running.

Product Application

The KFCC is designed for both Type I and Type II (grease and non-grease) constant volume hood systems, where starters are needed to activate fans. The control center can operate both single and three phase fans. Greenheck recommends using one KFCC per hood system (activates all fans simultaneously). When temperature interlock is provided in this package, it is not to be used in conjunction with exhaust fire dampers.

Receiving and Handling

Receiving

Upon receiving the product, check to make sure all items are accounted for by referencing the bill of lading to ensure all items were received. Notify the carrier if any damage is noticed. The carrier will make notification on the delivery receipt acknowledging any damage to the product. All damage should be noted on all of the copies of the bill of lading which is countersigned by the delivering carrier. If damaged upon arrival, file a claim with the carrier. Any physical damage to the unit after acceptance is not the responsibility of the manufacturer.

Unpacking

Verify that all required parts and the correct quantity of each item have been received. If any items are missing, report shortages to your local representative to arrange for obtaining missing parts.

Storage

If this product must be stored prior to installation, it must be protected from dirt and moisture. Indoor storage is highly recommended.

NOTE

Improper storage which results in damage to the unit will void the warranty.

Handling

Make sure the equipment does not suffer any heavy vibration or knocks.

Installation

Control Box Mounting

NOTE

Control box may be factory mounted. If so, continue to the next section.

Locate an area with enough space to mount the control box and fasten to the wall. Use appropriate type fasteners depending on the mounting location. Avoid installing the control box in environments with high magnetic and/or radio frequency interference.

Switch Mounting

NOTE

If the switches were NOT shipped loose, provided in a separate junction box, continue to the next section.

Locate an area with enough space to mount the switches junction box and fasten to the wall.

Temperature Sensor(s) - Hood Mounting

NOTE

Temperature sensor(s) will be provided only if the digital temperature interlock option was configured/ordered with the unit. If it wasn't, continue to the next section.

Temperature sensor(s) may be factory installed. If so, continue to the next section.

1. Locate flat area(s) at the top interior of the hood in front of the filters, towards the front of the hood.

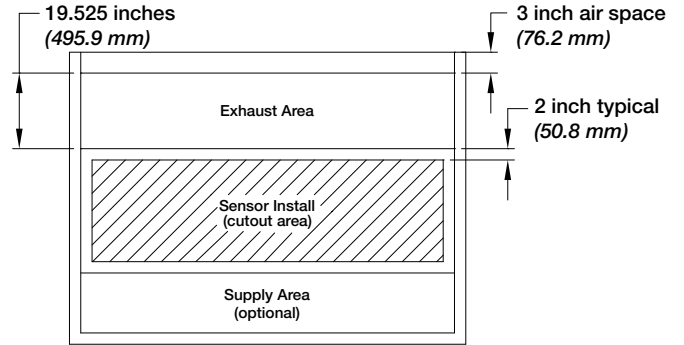

Top View of Exhaust Hood

2. Find a spot for the sensor in the flat space that will not interfere with the fire suppression nozzles and that is not within 12 inches (304.8 mm) of any light fixtures. Cut a 3/4 to 7/8-inch (19.0 to 22.2 mm) diameter hole in the flat spot of the capture tank.

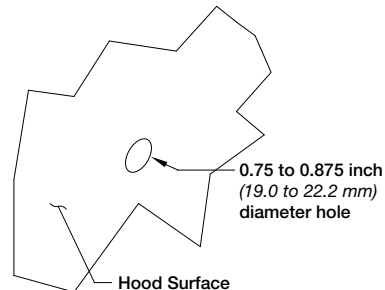

Temperature Sensor(s) - Hood Mounting, *continued*

- Place the J-box plate inside of the octagon extension ring and place over the hole.
- Disassemble the compression seal and place through hole and J-box plate as shown. Tighten the nut inside the octagon extension ring.

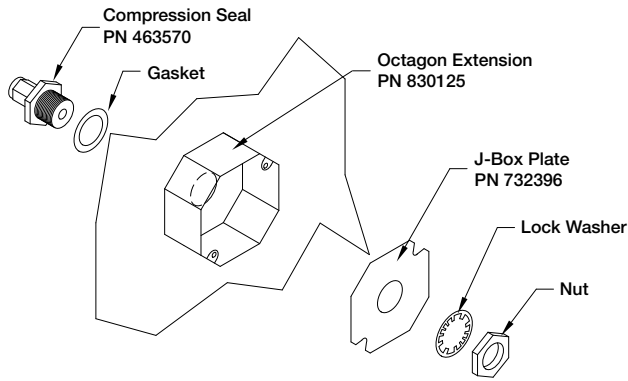

Exploded View (Components)

- Place the temperature sensor through the compression seal and tighten the compression fitting to 35 ft.-lbs. (47.5 Nm).

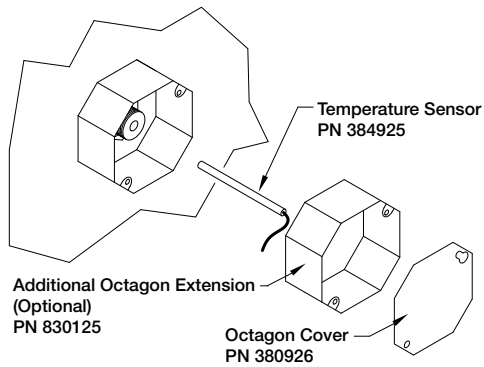

- Wire the sensor. Refer to Electrical Connections section for instructions on wiring the temperature sensor.
- Place octagon cover onto J-box and fasten it.

Temperature Sensor(s) - Duct Collar Mounting

- Locate the exhaust duct on top of the hood. Find a spot to mount the sensor where it will not interfere with fire suppression nozzles or other items installed in the ducts. If an exhaust fire damper is present in the hood exhaust collar, it must be removed prior to temperature sensor installation. A 3/4 to 7/8-inch (19.0 to 22.2 mm) diameter hole must be cut into the duct 2 inches (50.8 mm) above the hood top.

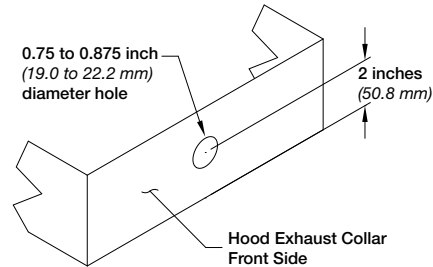

- Place the J-box plate inside of the octagon extension ring and place over the hole in the exhaust collar.
- Disassemble the compression seal and place through hole in duct collar and J-box plate as shown. Tighten the nut inside the octagon extension ring.

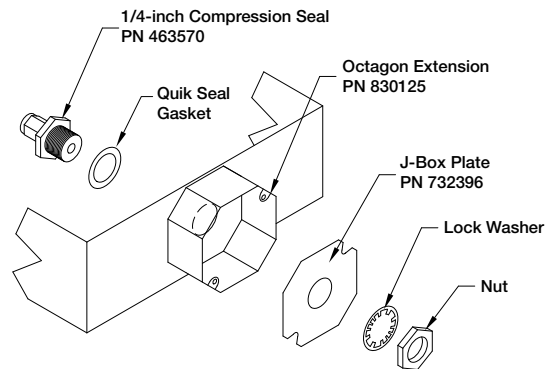

Exploded View (Components)

- Place the temperature sensor through the compression seal and tighten the compression fitting to 35 ft.-lbs. (47.5 Nm).

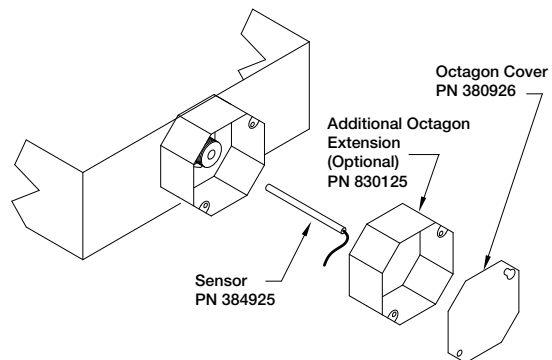

- Wire the sensor. Refer to Electrical Connections section for instructions on wiring the temperature sensor.
- Place octagon cover onto J-box and fasten it.

Thermostat(s) - Hood Mounting

NOTE

The thermostat(s) will be provided only if the thermostat style temperature interlock option was configured/ordered with the unit. If it wasn't, continue to the next section.

The thermostat(s) may be factory installed. If so, continue to the next section.

1. Locate the flat area(s) at the top interior of the hood in front of the filters, towards the front of the hood.

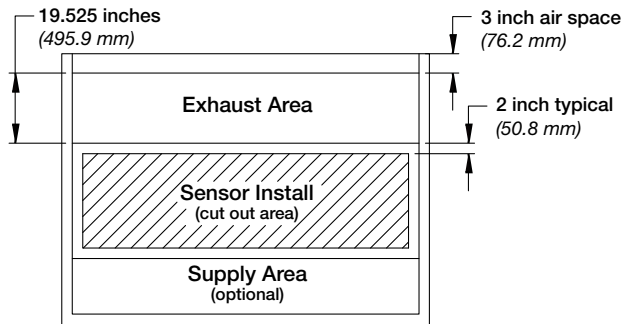

Hood Plan View

2. Find a suitable location for the sensor in the flat space that will not interfere with the fire suppression nozzles and that is not within 12 inches (304.8 mm) of any light fixtures. Cut a 1 1/8 to 1 1/4 inch (28.6 to 31.8 mm) diameter hole in the flat spot of the capture tank.

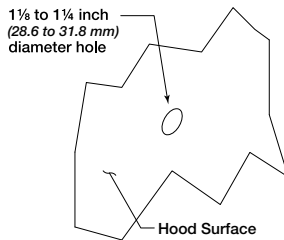

3. Place the J-box plate inside the octagon extension ring and place over the hole.
4. Disassemble the compression seal and place through hole and J-box plate as shown. Tighten the nut inside the octagon extension ring.

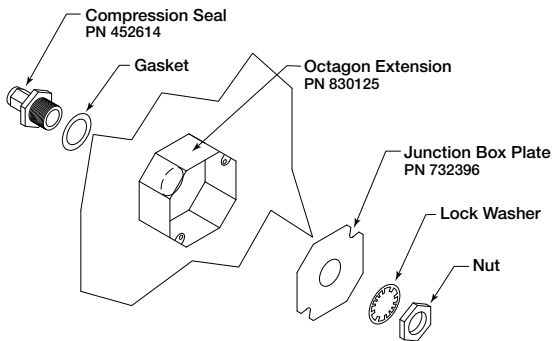

Exploded View (Components)

5. Place the thermostat through compression seal and tighten the compression fitting to 35 ft.-lbs. (47.5 Nm).
6. Wire the thermostat. Refer to Electrical Connections section for instructions on wiring the thermostat.
7. Place octagon cover onto J-box and fasten it.

Thermostat(s) – Duct Collar Mounting

1. Locate the exhaust duct on top of the hood. Find a spot to mount the thermostat where it will not interfere with fire suppression nozzles or other items installed in the ducts. If an exhaust fire damper is present in the hood exhaust collar, it must be removed prior to temperature sensor installation. A 1 1/8 to 1 1/4 inch (28.6 to 31.8 mm) diameter hole must be cut into the duct 2 inches (50.8 mm) above the hood top.

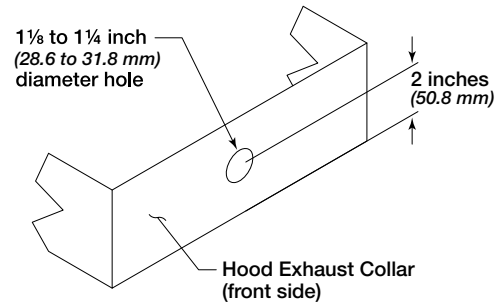

2. Place the J-box plate inside the octagon extension ring and place over the hole in the exhaust collar.
3. Disassemble the Quik-Seal fitting and place through hole in duct collar and J-box plate as shown. Tighten the nut inside the octagon extension ring.

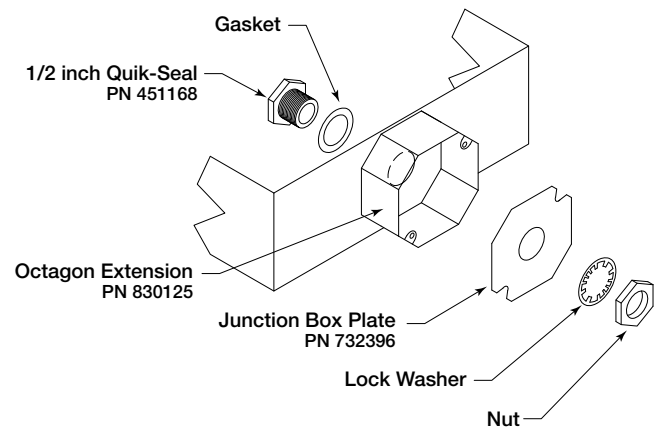

Exploded View (Components)

4. Thread the thermostat into the Quik-Seal fitting until secure.
5. Wire the thermostat. Refer to Electrical Connections section for instructions on wiring the thermostat.
6. Place octagon cover onto J-box and fasten it.

Electrical Connections

NOTE

All wiring of electrical equipment must be done to meet NEC and local codes.

NOTE

All field wire must be high temperature rated. All 115 VAC field wiring (or higher) must be routed through hard or flex conduit. All low voltage field wiring should be plenum rated if not routed through conduit. Field wiring should not come in contact with the surface of the hood. To reduce the likelihood of electromagnetic disturbance, avoid routing high and low voltage cables in the same cable conduit.

The extent of field wiring required will depend on the options and general configuration of the KFCC. Each option is broken out in the next portion of this manual. Each option will either be factory wired or will require field wiring. Use 14 AWG, 60°C copper wire unless otherwise specified.

Power for KFCC

The KFCC needs a power source to operate all inner components. This power source cannot be on a shunt trip breaker; the power must remain constant to the panel, even in the event of a kitchen fire.

Power for KFCC

- 115 VAC, 15 amp circuit to terminals H1 and N1

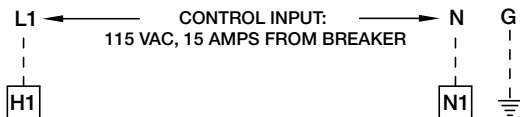

Power for Hood Lights (Optional)

If the KFCC is configured for hood light control, a separate power source for each light circuit will need to be run to the panel as well to power the lights. The KFCC can provide up to three light circuits.

Power for Hood Lights

- 115 VAC, 15 amp circuit to terminals H2 and N2 (first light circuit)
- 115 VAC, 15 amp circuit to terminals H3 and N3 (second light circuit)
- 115 VAC, 15 amp circuit to terminals H4 and N4 (third light circuit)

Hood Lights

- To terminals B2 and W2 (first light circuit)
- To terminals B3 and W3 (second light circuit)
- To terminals B4 and W4 (third light circuit)

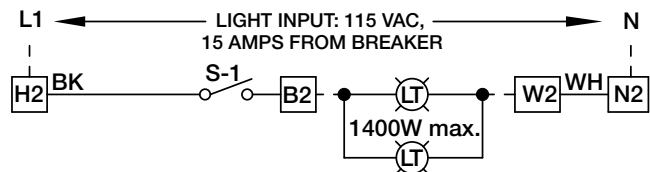

NOTE

Each light circuit must not exceed 1400W maximum. If panel is configured for lights out in fire, each light circuit must not exceed 900W maximum.

Hood lights may be directly wired to a light switch, creating unoccupied terminals B2, B3 and B4. Please refer to the wiring diagram specifically created for the panel on the inside door of the control center.

Power for Starters and Fans

The KFCC is equipped with contactors that may have thermal overloads attached to them. Each fan should have a designated power source. The breaker size (amps), wire gauge, phase, and voltage for each fan is specified on the KFCC wiring diagram.

115 VAC Single Phase Fan(s) Power Wiring

- LINE - from breaker to terminals L1 and L2
- LOAD, 115 VAC - from terminal block L2 and T3 on the bottom of contactor/overload to fan disconnect

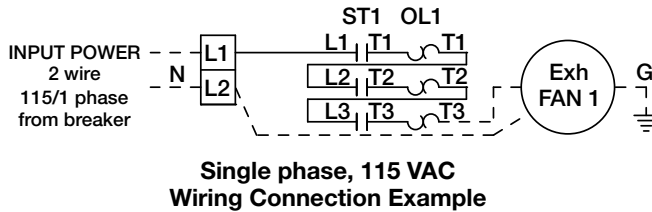

200/208/230/277 VAC Single Phase Fan(s) Power Wiring

- LINE - from breaker to terminals L1 and L2
- LOAD, 200/208/230/277 VAC - from T1 and T3 on the bottom of contactor/overload to fan disconnect

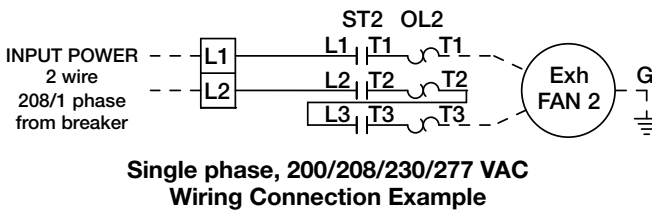

Three Phase Fan(s) Power Wiring

- LINE - from breaker to terminals L1, L2 and L3
- LOAD - from T1, T2 and T3 on the bottom of contactor/overload to fan disconnect

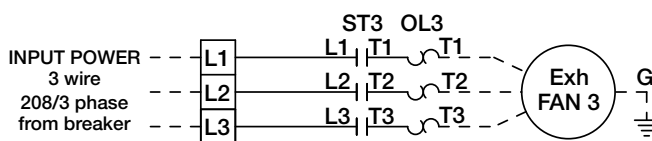

Fire System Integration

A dedicated fire system microswitch needs to be wired into the KFCC for all Type I hood systems. During a fire, this will disengage supply starters, and therefore turn off corresponding supply fans. If KFCC is configured with “Exhaust in Fire” option, the KFCC will also engage the exhaust starters, therefore turning on exhaust fans in the event of a fire.

Dedicated Fire System Microswitch

- Common to terminal C1
- Normally-closed to terminal NC1
- Normally-open to terminal NO1

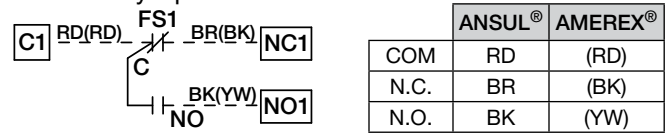

NOTE

C2, NC2, and NO2 terminals are provided for a second fire system microswitch. These terminals are not wired to any components; they are simply provided for a connection point only.

Wiring Multiple Fire Systems into KFCC

If wiring in multiple fire systems into one KFCC, a series connection of normally-closed contacts (a dedicated microswitch in each fire system) should be connected between terminals C1 and NC1. All normally-open wires from the microswitches used for the series connection between C1 and NC1 should be connected to terminal NO1.

- Common of first fire system switch to terminal C1
- Normally-closed of first fire system switch to common of second fire system switch
- Normally-closed of second fire system switch to terminal NC1
- Normally-open on both switches tie to terminal NO1

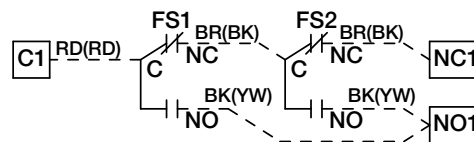

Spare Fire Contacts

The KFCC includes additional fire relay contacts standard for shunt trips, alarms, or additional utilities that need control signals to be sent in the event of a kitchen fire. The additional relay's state will only be changed if the dedicated fire system is wired into the KFCC. Wiring from added relays to terminals will be done in the factory.

Fire Relay

- Power to terminal C3
- From terminal NO3 (normally open; closes in fire) to device
- From terminal NC3 (normally closed; opens in fire) to device
- Power to terminal C4
- From terminal NO4 (normally open; closes in fire) to device
- From terminal NC4 (normally closed; opens in fire) to device

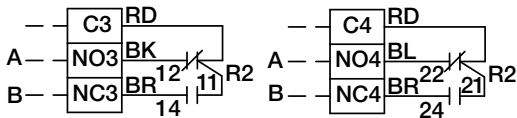

NOTE

Relay contacts will be dry unless otherwise noted on the panel's specific wiring diagram.

Do not use additional relay contacts for power interruption to appliances. Contacts are rated up to 250 VAC and 8 amps maximum.

Relay contacts will also switch state in the event power is lost to the control panel (terminals H1 and N1).

Switches (Optional)

A switch panel may be supplied to operate lights, fans, heating/cooling capabilities of a tempered supply, a damper, or another component of the kitchen exhaust system. If selected, the switch(es) will be provided one of four ways:

1. Shipped loose for remote mounting
2. Mounted on the hood
3. Mounted on the hood utility cabinet
4. Mounted on a wall utility cabinet

If the switches and the KFCC are both mounted on the same hood, wiring to the fan switches will be done in the factory.

Fan, 1-Speed

- To terminals S1H and S1* (first fan switch)
- To terminals S2H and S2* (second fan switch)
- To terminals S3H and S3* (third fan switch)

*S1N, S2N and S3N used if lighted toggle switches are utilized.

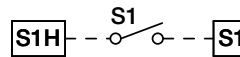

Ship Loose
Fan Switch Example

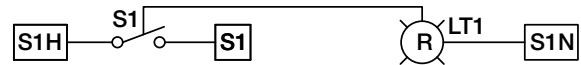

Factory Wired, Control Cabinet Mounted
Fan Switch Example

Fan, 2-Speed

- To terminals S1F, S1, and S1S (first 2-speed fan switch)

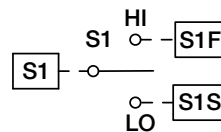

Ship Loose, 2-Speed
Fan Switch Example

Lights

- To terminals H2 and B2 (first light switch)
- To terminals H3 and B3 (second light switch)
- To terminals H4 and B4 (third light switch)

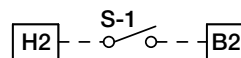

Tempered Supply, Heat Only

- To terminals R and W1

Tempered Supply, Cool Only

- To terminals R and Y1

Tempered Supply, Heat and Cool

- To terminals R (common), W1 (heat), and Y1 (cool)

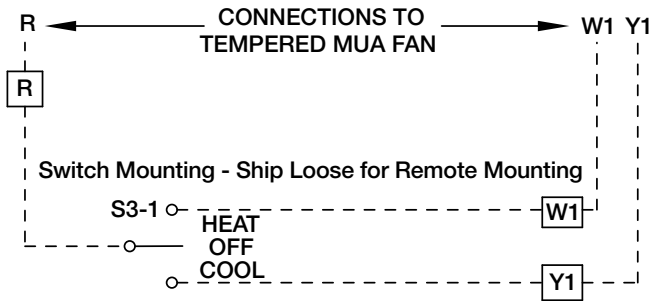

Shipped Loose
Make-Up Air Tempering Switch Example

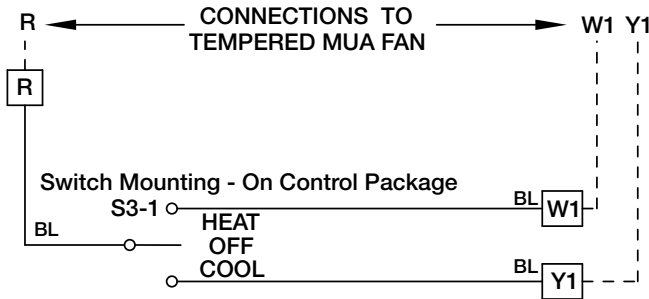

Mounted on Control Package
Make-Up Air Tempering Switch Example

Connections from these terminals will have to be made to the respective supply fan terminals R, W1 (if used), and Y1 (if used). Use proper gauge wire for field wiring depending on the voltage used.

When connecting to Greenheck's tempered Make-Up Air unit, connect R, W1 (if used), and Y1 (if used) up to the supply unit and land on R, W1 (if used), and Y1 (if used). This will be 24 VAC power, so 18 AWG shielded wire should be utilized.

Combination Fan/Light Switch

- To terminals S1H and S1

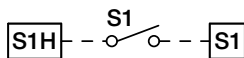

NOTE

For combination light/fans option, light circuit must not exceed 900W maximum.

Make-Up Air (MUA) Interface (Optional)

When the KFCC is interfaced with another Greenheck supply air unit, this option may omit the redundant starter in the KFCC, as the supply air unit may already be provided with one. This will be 24 VAC voltage; so 18 AWG, shielded control wire can be utilized.

Make-Up Air Unit

- From terminal R in MUA control center to terminal R in KFCC
- From terminal G in MUA control center to terminal G in KFCC

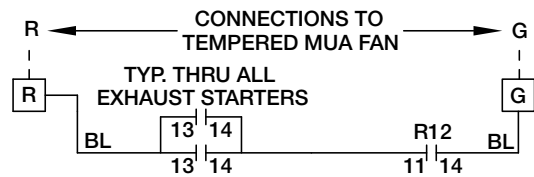

Power for Shunt Trip (Optional)

If the KFCC is configured with the power for shunt trip option, the KFCC will have terminals to connect an externally provided shunt trip breaker coil to allow the breakers to be tripped in the event of a fire. Connections include:

(Externally Provided) Shunt Trip Breakers

- To terminals STH and STN

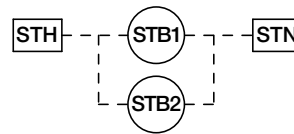

Audible Alarm (Optional)

With this option, an alarm will be provided and mounted on the panel that will sound in the event of a kitchen fire. This option will be factory-mounted and wired if selected.

Lights Out In Fire (Optional)

This option will turn off the kitchen hood lights in the event of a fire without the use of a shunt trip breaker. If provided, this option will be factory wired. Normal light circuit wiring should be followed. Please see either **Switches (Optional)**, **Lights** on page 8 or **Combination Light/Fan Switch** on page 9 for additional wiring information.

NOTE

For lights out in fire option, light circuit must not exceed 900W maximum.

Additional Fire Contacts (Optional)

The KFCC can include additional fire relays for shunt trips, alarms, or additional utilities that need control signals to be sent in the event of a kitchen fire. The additional relay's state will only be changed if the dedicated fire system is wired into the KFCC. Wiring from additional relays to terminals will be done at the factory.

Additional Fire Relay

- Power to terminal C9
- From terminal NO9 (normally open; closes in fire) to device
- From terminal NC9 (normally closed; opens in fire) to device
- Power to terminal C10
- From terminal NO10 (normally open; closes in fire) to device
- From terminal NC10 (normally closed; opens in fire) to device

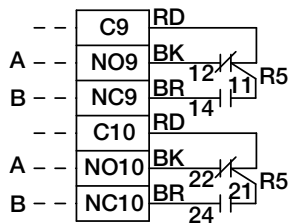

NOTE

Relay contacts will be dry. Power will need to be provided to the common terminal on each set.

Do not use additional relay contacts for power interruption to appliances. Contacts are rated up to 250 VAC and 8 amps maximum.

Relay contacts will also switch state in the event power is lost to the control panel (terminals H1 and N1).

Additional Exhaust Contacts (Optional)

The KFCC can include additional relays for devices that activate when the exhaust fan is running. Wiring from additional relays to terminals will be done at the factory.

Additional Exhaust Relay

- Power to terminal C7
- From terminal NO7 (normally open; closes with exhaust) to device
- From terminal NC7 (normally closed; opens with exhaust) to device
- Power to terminal C8
- From terminal NO8 (normally open; closes with exhaust) to device
- From terminal NC8 (normally closed; opens with exhaust) to device

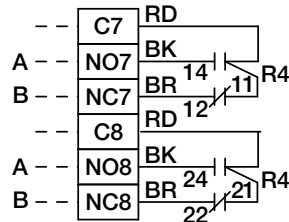

NOTE

Relay contacts will be dry. Power will need to be provided to the common terminal on each set.

Contacts are rated up to 250 VAC and 8 amps maximum.

Additional Supply Contacts (Optional)

The KFCC can include additional relays for devices that activate when the supply fan is running. Wiring from added relays to terminals will be done at the factory.

Additional Supply Relay

- Power to terminal C5
- From terminal NO5 (normally open; closes in fire) to device
- From terminal NC5 (normally closed; opens in fire) to device
- Power to terminal C6
- From terminal NO6 (normally open; closes in fire) to device
- From terminal NC6 (normally closed; opens in fire) to device

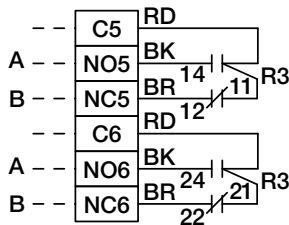

NOTE

Relay contacts will be dry. Power will need to be provided to the common terminal on each set.

Contacts are rated up to 250 VAC and 8 amps maximum.

Exhaust Fan Failure Indicator (Optional)

This option will provide a small indicator light on the front panel of the KFCC. A field provided air proving switch in the exhaust duct or current sensor on the exhaust fan power feed needs to be wired to a set of terminals, which will illuminate this light and provide a visual if the exhaust fan is not operating when the fans are turned on.

Air Flow Switch (field provided)

- To terminals AF1 and AF2

EXHAUST AIR FLOW SWITCH FIELD WIRED

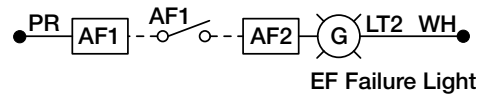

EF Failure Light

Supply Fan Failure Indicator (Optional)

This option will provide a small indicator light on the front panel of the KFCC. A field provided air proving switch in the supply duct or current sensor on the supply fan power feed needs to be wired to a set of terminals, which will illuminate this light and provide a visual if the supply fan is not operating when the fans are turned on.

Air Flow Switch (field provided)

- To terminals AF3 and AF4

SUPPLY AIR FLOW SWITCH FIELD WIRED

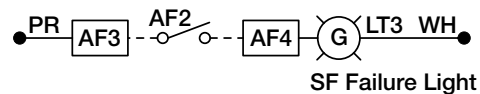

SF Failure Light

Status Lights (Optional)

The option adds status lights to the face of the KFCC. Power will have to be provided for each light in the field.

Status light(s)

- Bring 115 VAC power to SL1 and a neutral to SL2 (1st status light)
- Bring 115 VAC power to SL3 and a neutral to SL4 (2nd status light)

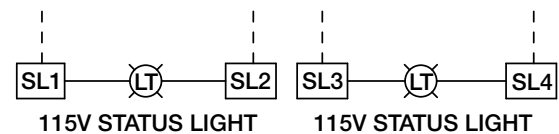

Example of two 115 VAC Status Lights

Temperature Interlock – Digital (Optional)

When configured with digital temperature interlock, the KFCC will include sensor(s) (located in the hood or shipped loose) and digital controllers. Unless already done by the factory, wire the two leads of each sensor to the control panel as shown below using low voltage, 18 AWG stranded wire. The two wires of each sensor are not polarity sensitive.

Digital Temperature Sensors

Choose the final connection option based on the table.

Sensor	Terminals
First Sensor	T1-A and T1-B
Others (if applicable)	T2-A and T2-B T3-A and T3-B T4-A and T4-B T5-A and T5-B T6-A and T6-B T7-A and T7-B T8-A and T8-B T9-A and T9-B T10-A and T10-B T11-A and T11-B T12-A and T12-B

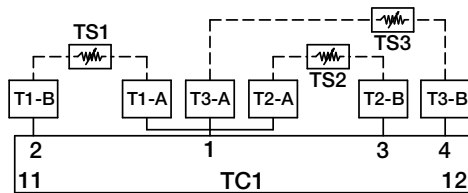

Wiring Example of Three Digital Temperature Interlock Sensors

NOTE

Do not connect temperature sensors in series. Separate as much as possible the probe and digital input cables from inductive loads and power cables, to avoid any electromagnetic disturbances. Never lay power and probe cables in the same cable conduits (including those for the electrical panel). Loosen every screw and insert the cable end. Next, tighten the screws and gently pull the cables to check their tightness.

Temperature Interlock – Thermostat (Optional)

When configured with thermostat style, temperature interlock, the KFCC will include thermostat(s) (mounted in hood or shipped loose) and a time delay relay. Unless already done by the factory, wire all thermostats in parallel back to terminal blocks T1-A and T1-B in control panel using 14 gauge 90°C minimum conductors.

Thermostat(s)

- To terminals T1-A and T1-B

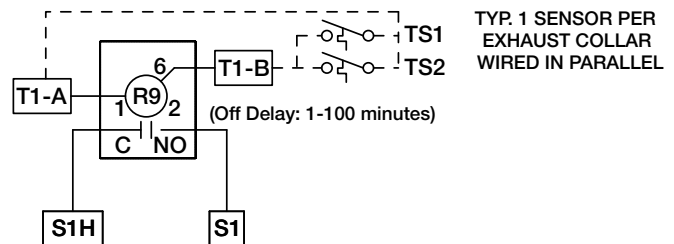

TYP. 1 SENSOR PER EXHAUST COLLAR WIRED IN PARALLEL

NOTE

Wire thermostats in parallel if multiple thermostats are utilized. Do not connect thermostats in series with each other.

Digital Style Temperature Interlock Configuration

NOTE

This section only applicable if the KFCC is configured with digital temperature interlock option.

Pre-programmed, digital temperature controller(s) will be provided to monitor temperatures detected by sensor(s) and engage fan(s).

The fan(s) will start running when a temperature exceeds the set point (defaulted at 90°F) plus differential (defaulted at 10°F). Once the temperature drops back below the set point AND the fan(s) have been running for a minimum run time (defaulted at 5 minutes), the fan(s) will shut off.

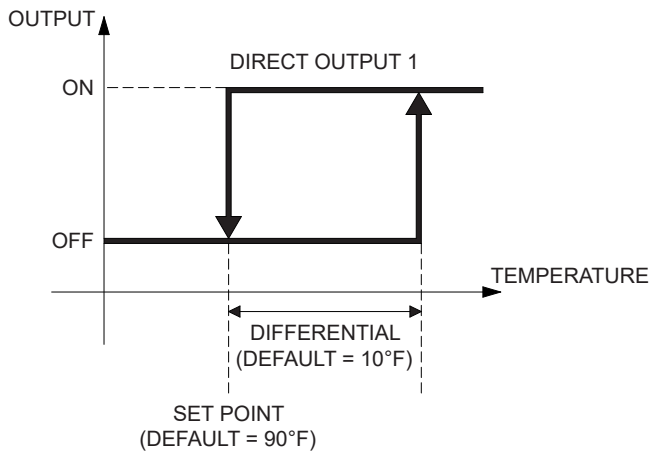

Calibration

Each controller is capable of monitoring up to three individual sensors. There will be an individual set point for each sensor input. The temperature set point may need to be adjusted slightly depending on both ambient and cooking conditions. To adjust the set points on the controller, follow these instructions:

1. Press **Set** button. ‘St1’ will appear.
2. Press **△** or **▽** button to navigate to set point that you wish to adjust (St1, St2, or St3).
3. Press **Set** button to view current set point. Press **△** or **▽** button to adjust and press **Set** button to store value.
4. Press **Set** + **▽** buttons together to exit set point menu or wait 1 minute.

Show Sensor Values

Press **Set** + **△** buttons together to show sensor and value, and press these two buttons together again to see additional sensors connected. ‘Sd1’ represents sensor input one, ‘Sd2’ represents sensor input two, and ‘Sd3’ represents sensor input three (relative to each controller). After 1 minute of no button presses, the controller will go back to displaying the first programmed input (see parameters P31, P32, P33).

Factory Parameters

NOTE

The controller is pre-programmed at the factory to operate based on how many sensors were selected. Adjustments (outside of the set point temperatures discussed in calibration section) should only be made under factory instruction. The list provided is for reference only.

To access/adjust all factory parameters, follow these instructions:

1. Press and hold **[Set]** button for 30 seconds or until '0' appears.

2. Press **[Set]** button to enter parameter list.
3. With **[△]** or **[▽]** button navigate to the desired parameter on the list of parameters.
4. Press **[Set]** button to see the current set value.
5. Press either **[△]** or **[▽]** button to set the desired new value.
6. Press **[Set]** button to confirm it and exit to the parameter list.
7. Press **[Set]** + **[▽]** buttons together to exit the programming menu or wait 1 minute (keypad timeout).

Temperature Controller Parameters					
	Description	Units	1 Sensor Program	2 Sensor Program	3 Sensor Program
St1	Setpoint Value Sensor 1	Degrees	90.0	90.0	90.0
St2	Setpoint Value Sensor 2	Degrees	3.0	90.0	90.0
St3	Setpoint Value Sensor 3	Degrees	3.0	3.0	90.0
r01	Differential Sensor 1	Degrees	10.0	10.0	10.0
r02	Differential Sensor 2	Degrees	1.0	10.0	10.0
r03	Differential Sensor 3	Degrees	1.0	1.0	10.0
r4	Minimum Setpoint Value	Degrees	-50.0	-50.0	-50.0
r5	Maximum Setpoint Value	Degrees	150.0	150.0	150.0
c01	Mode Sensor 1	Range	dir	dir	dir
c02	Mode Sensor 2	Range	inu	dir	dir
c03	Mode Sensor 3	Range	inu	inu	dir
c11	Minimum Output 1 Stop Time	Minutes	5.0	5.0	5.0
c12	Minimum Output 2 Stop Time	Minutes	0.0	5.0	5.0
c13	Minimum Output 3 Stop time	Minutes	0.0	0.0	5.0
c21	Minimum Output 1 On Time	Minutes	0.0	0.0	0.0
c22	Minimum Output 2 On Time	Minutes	0.0	0.0	0.0
c23	Minimum Output 3 On Time	Minutes	0.0	0.0	0.0
c31	On Time Fault Sensor 1 Cycle	Minutes	1.0	1.0	1.0
c32	On Time Fault Sensor 2 Cycle	Minutes	0.0	1.0	1.0
c33	On Time Fault Sensor 3 Cycle	Minutes	0.0	0.0	1.0
c41	Off Time Fault Sensor 1 Cycle	Minutes	0.0	0.0	0.0
c42	Off Time Fault Sensor 2 Cycle	Minutes	0.0	0.0	0.0
c43	Off Time Fault Sensor 3 Cycle	Minutes	0.0	0.0	0.0
P0	Temp Scale	Option	F	F	F
P11	Sensor 1 Calibration	Degrees	0.0	0.0	0.0
P12	Sensor 2 Calibration	Degrees	0.0	0.0	0.0
P13	Sensor 3 Calibration	Degrees	0.0	0.0	0.0
P2	Decimal Point	Option	YES	YES	YES
P31	Sensor 1 Present	Option	YES	YES	YES
P32	Sensor 2 Present	Option	NO	YES	YES
P33	Sensor 3 Present	Option	NO	NO	YES
H2	Keypad Protection	Option	NO	NO	NO
H4	Serial Communications Address	Range	0	0	0
H5	Keypad Code	Range	0	0	0
H6	Type of Sensor	Option	Pt1	Pt1	Pt1

Shaded values are changed by the factory

Thermostat Style Temperature Interlock Configuration

NOTE

This section only applicable if the KFCC is configured with thermostat style temperature interlock.

Calibration

Thermostat is preset by factory to 95°F (35°C) and has a slow make and break contact. It will make contact on a temperature rise and break contact on temperature fall. The temperature set point may have to be adjusted slightly depending of both ambient and cooking conditions. The adjustment knob is located on the back of the thermostat. Use a small blade screwdriver to make the adjustments.

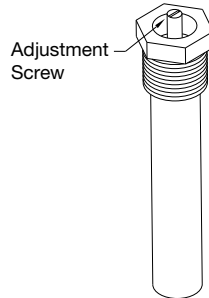

1. Turn counterclockwise to increase the temperature set point, turn clockwise to decrease the temperature set point.
2. Quarter revolution in either direction corresponds to a 22.5°F (12.5°C) adjustment. Be sure to make small adjustments, about 1/16 of a turn ($\approx 6^\circ\text{F}$) or less at one time.
3. Do not exceed more than one-half revolution in either direction.
4. Check system operation before making additional adjustments.

KFCC Field Connection Checklist

Power to KFCC Cabinet and Lights

- 115 VAC power for controls (terminals H1, N1)
- 115 VAC power for hood lights, one per light circuit (terminals H2, N2 | H3, N3 | H4, N4)
- Connect lights, one per light circuit (terminals B2, W2 | B3, W3 | B4, W4)
(Lights may be directly wired to switch)

Power for Fans

- 115/200/208/230/277 VAC power, single phase fans from breaker (terminals L1, L2)
- 208/230/277/460/575 VAC power, three phase fans from breaker (terminals L1, L2, L3)
- 115 VAC power for single phase to fan (contactor/overload T3, terminal L2 is neutral)
- 208/230/277/460 VAC power to single phase fan (contactor/overload T1, T3)
- 208/460/575 VAC power to three phase fan (contactor/overload T1, T2, T3)

Fire System

- Microswitch C, N.O., and N.C. (terminals C1, NO1, NC1)

Spare Fire Contacts

- Spare, dry relay contact (terminals C3, NO3, NC3)
- Spare, dry relay contact (terminals C4, NO4, NC4)

Switches - if equipped

- Fan, 1-Speed (terminals S_H, S_; S_N is neutral if lighted)
- Fan, 2-Speed (terminals S_F, S_S, S_))
- Light (terminals H2, B2 or H3, B3 or H4, B4; may be directly wired to hood lights)
- Thermal, heat only (terminals R, W1)
- Thermal, cool only (terminals R, Y1)
- Thermal, heat and cool (terminals R, W1, Y1)

MUA Interface - if equipped

- To MUA Control Center (terminals R, G)

Power for Shunt Trip - if equipped

- Shunt trip breaker coil (terminals STH, STN)

Additional Fire Contacts - if equipped

- Spare, dry relay contact (terminals C9, NO9, NC9)
- Spare, dry relay contact (terminals C10, NO10, NC10)

Additional Exhaust Contacts - if equipped

- Spare, dry relay contact (terminals C7, NO7, NC7)
- Spare, dry relay contact (terminals C8, NO8, NC8)

Additional Supply Contacts - if equipped

- Spare, dry relay contact (terminals C5, NO5, NC5)
- Spare, dry relay contact (terminals C6, NO6, NC6)

Exhaust Fan Failure Indicator - if equipped

- Field provided airflow switch or current sensor (terminals AF1, AF2)

Supply Fan Failure Indicator - if equipped

- Field provided airflow switch or current sensor (terminals AF3, AF4)

Status Lights (115 VAC) - if equipped

- Status light one (terminals SL1, SL2)
- Status light two (terminals SL3, SL4)

Digital Style Temperature Interlock - if equipped

- Sensor(s) (terminals T_-A, T_-B)

Thermostat Style Temperature Interlock - if equipped

- Thermostat(s) (wired in parallel between terminals T1-A, T1-B)

General Wiring Diagram

This is an example of a generic wiring diagram of a KFCC. The KFCC is configured with two exhaust fans and one supply fan, as well as three digital interlock sensors. To see your job specific drawing, look on the inside panel of the KFCC.

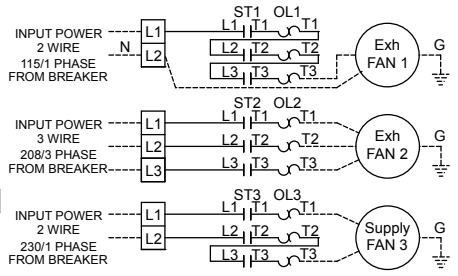
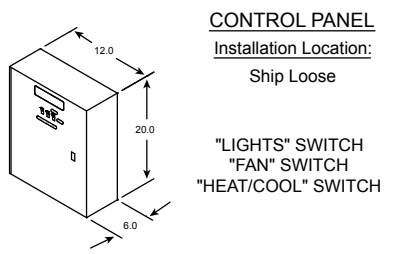
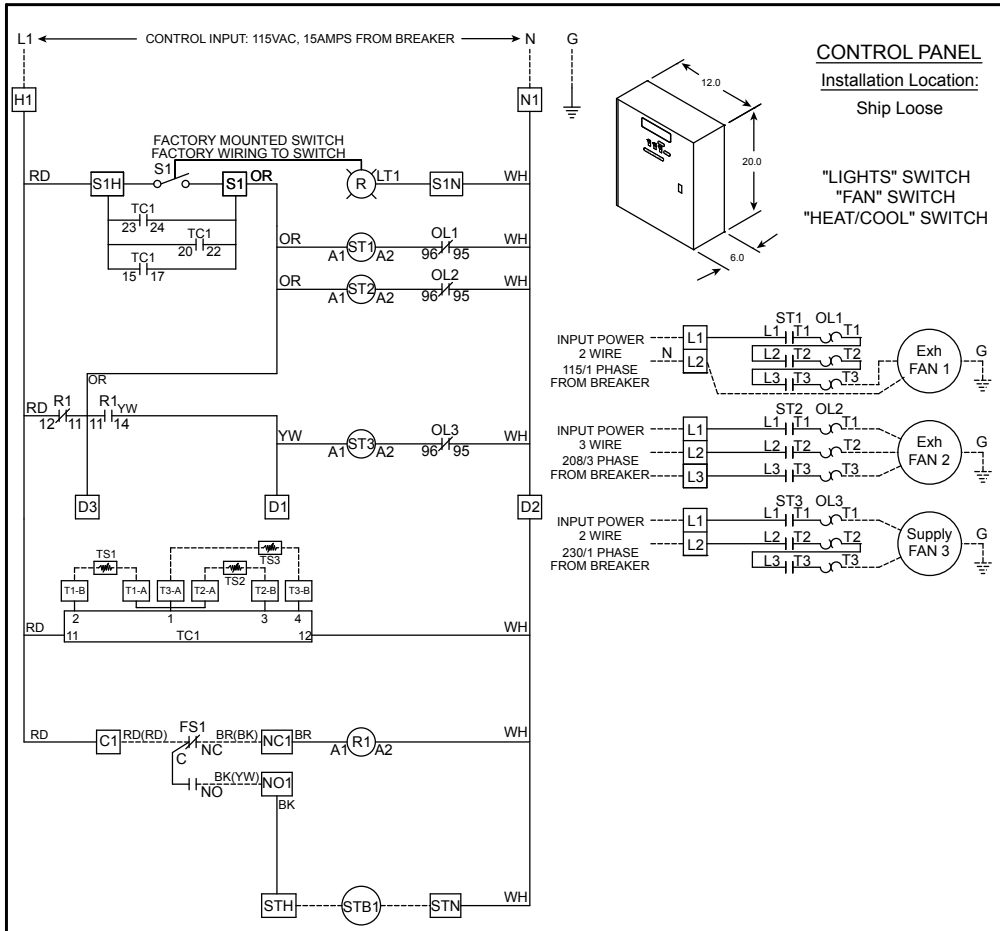

Switches Mounting - On Control Package

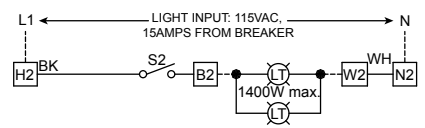

TEMPERATURE INTERLOCK CALIBRATION

1. PRESS SET BUTTON. 'S1' WILL APPEAR.
2. PRESS UP OR DOWN BUTTON TO NAVIGATE TO SET POINT THAT YOU WISH TO ADJUST ('S1', 'S2', OR 'S3').
3. PRESS SET BUTTON TO VIEW CURRENT SET POINT. PRESS UP OR DOWN BUTTON TO ADJUST AND PRESS SET BUTTON TO STORE VALUE.
4. PRESS SET + DOWN BUTTONS TOGETHER TO EXIT OR WAIT 1 MINUTE.
5. CHECK SYSTEM OPERATION BEFORE MAKING ADDITIONAL ADJUSTMENTS.

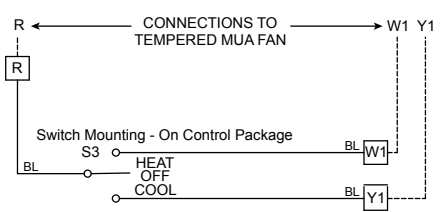

Panel Mark:		Controls						
Hood Mark(s):								
Motor	Fan Mark	HP	Volt	PH	FLA	Wire	Breaker	
F1-E	EF-1	1	115	1	16.0	12 ga	20 amp	
F2-E	EF-2	0.5	208	3	2.4	14 ga	15 amp	
F3-S	SF-1	0.75	230	1	6.9	14 ga	15 amp	

<input type="checkbox"/> Qty. Fan Switches (0-3)	<input type="checkbox"/> Exhaust in Fire
<input type="checkbox"/> Qty. Light Switches (0-3)	<input type="checkbox"/> MUA Interface
<input type="checkbox"/> Qty. Temp. Switches (0-1)	<input type="checkbox"/> Lights Out in Fire
<input type="checkbox"/> One Switch for L & F	<input type="checkbox"/> Fire Relay (#1)
<input type="checkbox"/> Digital Temperature Interlock	<input type="checkbox"/> Extra Fire Relay (#2)
<input type="checkbox"/> Mounted Sensors - Factory	<input type="checkbox"/> Extra Fire Relay (#3)
<input type="checkbox"/> Mounted Sensors - Field	<input type="checkbox"/> DPDT Relay w/SF
<input type="checkbox"/> Heat Switch	<input type="checkbox"/> DPDT Relay w/EF
<input type="checkbox"/> Cool Switch/ Tempering SW	<input type="checkbox"/> Off Delay Relay
<input type="checkbox"/> AD Switch	<input type="checkbox"/> SF Failure Light
<input type="checkbox"/> Remote Switches	<input type="checkbox"/> EF Failure Light
<input type="checkbox"/> Audible Alarm	<input type="checkbox"/> Fan Failure Light (Appl.)
<input type="checkbox"/> Gas Reset	<input type="checkbox"/> Aux. Supply Contact
<input type="checkbox"/> Power for Gas Solenoid	<input type="checkbox"/> SDR
<input type="checkbox"/> Power for Shunt Trip	

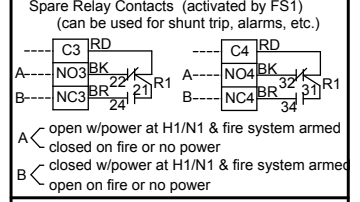
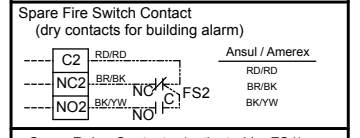

TORQUE:	FIELD WIRING:
TERMINAL BLOCKS = 8 LB.IN	USE MINIMUM
GROUNDING BLOCKS = 8 LB.IN	60" Copper Wire

LABEL DESCRIPTION	
EF Exhaust Fan	FACTORY WIRING
SF Supply Fan	FIELD WIRING
ST Starter	
OL OverLoad	ALL WIRING 90°C 14 GA.
C Contactor	UNLESS SPECIFIED
G Ground	
S Switch	
LT Light	
FS Fire Switch	
R Relay	BK - black
AV Air Flow Switch	BL - blue
GS Gas Solenoid	BR - brown
STB Shunt Trip Breaker	OR - orange
D Damper	PR - purple
PB PushButton	RD - red
EC Evap Cooler	YW - yellow
TS Temperature Sensor	WH - white
TC Temperature Controller	

NOTES:
 DRAWING SHOWN DE-ENERGIZED AT L1 (TERM. #H1),
 W/ FIRE SYSTEM ARMED (NON-FIRE MODE). (NORMAL
 OPERATION, R1 & R2 ARE ENERGIZED) IF WALL
 MOUNTED PREWIRE, OR FIELD INSTALLED FIRE
 SYSTEM, THE FIRE SYSTEM MICROSWITCHES MUST
 BE FIELD WIRED.

UL LISTED 435M	COMMERCIAL APPLIANCE OUTLET CENTER
	ELECTRICAL RATINGS: 120V, 1PHASE, 60HZ, 15A FILE #E313951

Wiring Diagram Code:

Testing

1. Turn the fan switch(es) on, then off to ensure proper fan operation before cooking equipment is started. Once this is verified, testing can proceed.
2. If applicable, turn the light switch(es) on, then off to ensure proper light operation in the hood. Once this is verified, testing can proceed.
3. Press and hold down the fire suppression switch connected to the KFCC and verify that the corresponding exhaust and/or supply fan(s) react appropriately when in the fire state. Verify all shunt trip breakers, alarms, and other components utilizing any of the spare relay contacts in the KFCC are activated properly.
4. **If the KFCC is configured with thermostat style temperature interlock, please follow steps 5 through 9 below. If the KFCC is configured with digital temperature interlock, please follow steps 10 through 12.**
5. For testing only, locate the time delay relay. Turn the time adjustment knob counterclockwise to the first mark in order to expedite the testing process. Make a note as to where the timed relay was originally set.
6. Heat up cooking equipment with fans off. Once the temperature reaches the set point of the thermostat the fans will start, preferably within 5 to 10 minutes. If the fans take more than 15 minutes to start, decrease the temperature set point by turning the adjustment screw 1/16 turn clockwise. Do not apply direct flame to the thermostat.
7. If an adjustment was made in Step 6, repeat now.
8. After verification of fan start-up, shut down cooking equipment. The fan switch should still be in the off position. Once cooking equipment has cooled, the thermostat will open triggering the timer function in the time delay relay to begin. Once time has expired, the fans will shut down. Thermostat operation can be verified by checking voltage (115 VAC) between terminal blocks T1-B and N1 on the control panel. 115 VAC will be present when the thermostat senses heat.
9. Once proper operation has been verified, set the dial on the timed relay to its original setting (approximately 20 minute delay).
10. With the fans turned off by the fan switch, turn on at least one piece of cooking equipment under the hood. The fans should automatically start within 5 to 10 minutes. If the fans take more than 15 minutes to start, decrease the temperature set point(s) on the temperature controller (see Digital Style Temperature Interlock Configuration, page 13).
11. If an adjustment was made in Step 10, repeat now.
12. After verification of fan start-up, shut down cooking equipment. The fan switch should still be in the off position. Once cooking equipment has cooled below the set point, the fans will shut down.

CAUTION

If provided with temperature interlock, the sensors/thermostats should never be exposed to direct flame. Exposing a sensor/thermostat to direct flame may render the sensor/thermostat inoperable and will void the warranty.

NOTE

During testing, if the KFCC is configured with temperature interlock and fans do not start automatically in the first 15 minutes of cooking equipment activation, manually start fans to avoid accidental fire system dump due to heat build-up.

Operation

1. Turn fans on and off using the fan switch.
2. **If KFCC is configured to control hood lights**, turn hood lights on and off using the light switch.
3. **If KFCC is configured with digital style temperature interlock**, it is normal for the fan(s) to remain running after the switch is turned off. The exhaust temperature controller will shut down fans after heat is no longer present under the hood and the temperature is below the set point. In the event that the cooking equipment is started without turning the fans on manually, the fans will turn on automatically and remain running with the presence of heat under the hood. Once the temperature is below the set point, the fans will shut down.
4. **If KFCC is configured with thermostat style temperature interlock**, it is normal for the fan(s) to remain running after the fan switch is turned off. The exhaust thermostat will open after heat is no longer present under the hood which will activate the timed relay to begin its countdown. Once time has expired, fans will shut down. The timed relay is adjustable from 1-100 minutes. The recommended time delay setting is approximately 20 minutes.

Troubleshooting

1. Fan(s) do not turn on automatically upon cooking equipment activation

- Confirm that the KFCC has been configured with temperature interlock, either thermostat style or digital style.
- Check wiring to control panel. With thermostat style interlock, thermostats must be wired in parallel. With digital style interlock, sensors must be wired to the control panel separately.
- Temperature set point is too high, decrease set point.
- No power to fan(s), check breakers/starters/relays.

2. Controller(s) in KFCC display EP1 or EP2 and EP3 fan(s) will not shut off.

- EP1, EP2 and EP3 represent sensor errors.
- Disconnect the sensor from the system, and check resistance between the two wires on the sensor. At room temperature (77°F or 25°C), the sensor should read 1097.4 ohms.
- Check wiring connections between the sensor and control cabinet.

3. Fan(s) do not shut off.

- Fan switch must be in the off position.
- If the KFCC is configured with digital style temperature interlock, check the controller to determine if there is a sensor error of EP1, EP2 and/or EP3. If yes, refer to the controller display error message, item 2 above.
- Cooking equipment is still hot, and the KFCC is configured with temperature interlock. Wait for the equipment to cool.
- Temperature set point for temperature interlock is set too low, increase set point.
- Check control circuit (fan starter) wiring.

4. Exhaust fan(s) will not shut off, and supply fan(s) will not turn on.

- Check hood for fire system dump.
- If no fire system dump has occurred, check fire system wiring between fire system microswitch and control panel.

5. Fan(s) do not turn on quick enough.

- Decrease temperature set point

Maintenance

Daily

If KFCC is configured with temperature interlock, clean thermostat or sensor with cloth and degreaser. Keep clean for best performance; can clean weekly depending upon grease accumulation.

Weekly

Depending on grease production and grease filter type in the hood, temperature thermostats or sensors can be cleaned weekly.

Seasonal

If KFCC is configured with temperature interlock, may have to change temperature settings if ambient kitchen temperatures fluctuate between summer and winter seasons.

Whom to call

Contact your local manufacturer's representative.

What to have ready for the call

Sales order, serial number and description of product.

Sales Order Number _____

Serial Number _____

Frequently Asked Questions Regarding Temperature Interlock

What temperature is the thermostat/temperature interlock set from the factory?

Thermostat style: 95°F

Digital style: 90°F set point + 10°F hysteresis

How do I determine if the KFCC is configured with thermostat style or digital style temperature interlock?

Thermostat style interlock uses 5/8-inch diameter sensor(s) mounted in either the hood capture area or exhaust collar(s). The KFCC will include a solid-state relay with a 1-100 minute off-delay dial. Inspect the sensor diameter or look inside the KFCC for this solid-state relay.

Digital style interlock uses 1/4-inch diameter sensor(s) mounted in either the hood capture area or exhaust collar(s). The KFCC will include a controller with a digital read out, capable of displaying different temperature values. Inspect the sensor diameter or look inside the KFCC for this digital-displaying controller.

Will the temperature interlock automatically start/stop the fans?

When connected properly to the fan starters the temperature interlock will automatically control the fans without input from the user. However, the intended use of the temperature interlock is as a back-up to manual control.

With thermostat style interlock, what is the purpose of the timer in the KFCC?

The timer is used to delay the shut down of the fans, to prevent fan on/off cycling while the temperature in the exhaust duct can reach steady state. Without the delay, cycling could occur both on startup or shutdown of cooking equipment. The delay is typically set at 20 minutes.

How many individual breakers does the KFCC require?

The number of individual breakers depends the number of fans controlled and options included in the KFCC. Each individual fan typically requires its own breaker. The KFCC main power requires its own breaker. Each light circuit is typically put on individual breakers.

Can I still turn my fan on and off?

Yes, the temperature interlock is designed to operate with a typical on/off switch. The fan may not turn off immediately after turning the fan switch off, it will sense when the cooking operations have cooled and then turn off.

Replacement Parts

Part Number	Description
384905	Terminal Block, Single Pole, DIN-RAIL MT, ABB ZS6
384908	Jumper, DIN-RAIL Terminal Block 2 Pole ABB JB6-2
383559	DPDT Relay Base Finder 95853
383560	DPDT Relay Finder 40528120000 115 VAC DPDT Relay
Digital Style Temperature Interlock	
384925	Temperature Sensor (RTD) Dwyer TE-IBN-E0448-00
880601	Temperature Controller Programmed for 1 sensor Dwyer TSDIN-013-G
880602	Temperature Controller Programmed for 2 sensors Dwyer TSDIN-013-G
880603	Temperature Controller Programmed for 3 sensors Dwyer TSDIN-013-G
830125	Extension, Octagon (drilled) SC55151-1/2 (380928)
732396	J-Box Plate
380926	Cover, Octagon Box SC#54-C-1RACO 722
463570	Evergreen Compression Seal 1/4-inch, #302
Thermostat Style Temperature Interlock	
383923	Thermostat, Vulcan 1C2B9 5/8-inch Type C
451168	Evergreen Quik-Seal, 1/2-inch #171 (1-1/8 inch hole size)
830125	Extension, Octagon (drilled) SC55151-1/2 (380928)
380926	Cover, Octagon Box SC#54-C-1RACO 722
383271	Timer SSAC #KRDB424 SPST 1-100 min.
452614	Evergreen Compression Seal, 5/8-inch, #302
732396	J-Box Plate

Codes and Standards Compliance

- UL 710 and UL 891
- National Fire Protection Association (NFPA 96)
- National Electrical Code (NEC)
- Canadian Electrical Code (CEC)

With Temperature Interlock Option Included:

- International Mechanical Code (IMC) 2015 Section 507.1.1

Maintenance Log

Date _____ Time _____ AM/PM

Notes: _____

Date _____ Time _____ AM/PM

Notes: _____

Date _____ Time _____ AM/PM

Notes: _____

Date _____ Time _____ AM/PM

Notes: _____

Date _____ Time _____ AM/PM

Notes: _____

Date _____ Time _____ AM/PM

Notes: _____

Date _____ Time _____ AM/PM

Notes: _____

Date _____ Time _____ AM/PM

Notes: _____

Date _____ Time _____ AM/PM

Notes: _____

Date _____ Time _____ AM/PM

Notes: _____

Date _____ Time _____ AM/PM

Notes: _____

Date _____ Time _____ AM/PM

Notes: _____



Maintenance Log

Date _____ Time _____ AM/PM

Notes: _____

Date _____ Time _____ AM/PM

Notes: _____

Date _____ Time _____ AM/PM

Notes: _____

Date _____ Time _____ AM/PM

Notes: _____

Date _____ Time _____ AM/PM

Notes: _____

Date _____ Time _____ AM/PM

Notes: _____

Date _____ Time _____ AM/PM

Notes: _____

Date _____ Time _____ AM/PM

Notes: _____

Date _____ Time _____ AM/PM

Notes: _____

Date _____ Time _____ AM/PM

Notes: _____

Date _____ Time _____ AM/PM

Notes: _____

Date _____ Time _____ AM/PM

Notes: _____

Our Commitment

As a result of our commitment to continuous improvement, Greenheck reserves the right to change specifications without notice.

Specific Greenheck product warranties are located on greenheck.com within the product area tabs and in the Library under Warranties.

Greenheck's Kitchen Ventilation Systems, Controls and Energy Management catalog, provides additional information describing the equipment, fan performance, available accessories, and specification data.

AMCA Publication 410-96, Safety Practices for Users and Installers of Industrial and Commercial Fans, provides additional safety information. This publication can be obtained from AMCA International, Inc. at www.amca.org.

