

## Reference Guide for Microprocessor Controller

Please read and save these instructions for future reference. Read carefully before attempting to assemble, install, operate or maintain the product described. Protect yourself and others by observing all safety information. Failure to comply with instructions could result in personal injury and/or property damage!

### TAP v2.50

Version Date: 5/1/17



## Introduction

### Program Features

The microprocessor controller offers improved control through easy monitoring and adjustment of unit parameters by way of a lighted graphical display and an integral push-button keypad.

### Pre-Programmed Operating Sequences

The controller has been pre-programmed to offer multiple control sequences to provide tempered air. Factory default settings allow for easy setup and commissioning. The sequence parameters are fully adjustable. Refer to the Sequence of Operation beginning on page 2 for details.

### BMS Communication

With the addition of an optional BMS Communication card, the user can remotely adjust set points, view unit status points and alarms. The microprocessor controller is capable of communicating over several protocols:

- BACnet® MSTP
- LonWork®
- BACnet® IP/Ethernet
- Modbus

See Points List for a complete list of BMS points.

### Internal Time Clock (Schedule)

The controller has an internal programmable time clock, allowing the user to add up to seven different occupancy schedules. The user may also add holidays for additional energy savings. The time clock option also has morning warm-up capability for optimal comfort at the time of occupancy.

### Alarm Management

The microprocessor controller will monitor the unit's status for alarm conditions. Upon detecting an alarm, the controller will record the alarm description, time, date, temperatures, and unit status for user review. A digital output is reserved for remote alarm indication. Alarms are also communicated via BMS (if protocol card is equipped).

### Occupancy Modes

The microprocessor controller offers three modes of determining occupancy: a dry contact, the internal time clock or the BMS. If in the unoccupied mode the unit will either be shut down, or will cycle on to maintain adjustable unoccupied room temperature and humidity set points (room temperature sensor is optional).

### Remote Display Panel (Optional)

A touch pad display panel allows for remote monitoring and adjustment of parameters, allowing ease of control access without going outdoors.









#### WARNING

Electrical shock hazard. Can cause personal injury or equipment damage. Service must be performed only by personnel that are knowledgeable in the operation of the equipment being controlled.

#### WARNING

Mechanical high static protection cutoffs must be installed by others to protect the system and equipment from over-pressurization when using factory provided control sensors. The manufacturer does not assume responsibility for this.

## Table of Contents

Sequence of Operation		Points List	
General Operation . . . . .	3	LonWorks® . . . . .	38-39
Set Point Control. . . . .	3	ModBus/BACnet®. . . . .	40-41
Heating. . . . .	4	Remote Display . . . . .	42
Cooling. . . . .	4	NTC Temperature Sensor Chart . . . . .	42
Economizer . . . . .	4	Economizer Commissioning Tool . . . . .	43
Dehumidification. . . . .	4	Troubleshooting . . . . .	43
Reheat . . . . .	5	Appendix A	
Supply Fan VFD . . . . .	5	BACnet® MSTP Quick Start . . . . .	44
Exhaust Fan VFD . . . . .	5	BACnet® IP/Eth Quick Start. . . . .	45
Outdoor Air and Recirculated (Recirc) Air . . . . .	5	Appendix B: Room Thermostat Quick Start. . . . .	46-47
Energy Recovery Wheel Sequence . . . . .	6	Appendix C: GreenTrol Quick Start . . . . .	48-48
Alarms . . . . .	6	Appendix D : Expansion I/O (pCOe) Quick Start . . . . .	50
pCOe Controller Overview		Appendix E: ModBus Wiring. . . . .	51
4:1 Furnace . . . . .	7	Maintenance Log . . . . .	Backcover
High Turndown Furnace . . . . .	7	Our Commitment. . . . .	Backcover
Controller Overview . . . . .	8-9		
Display Use . . . . .	9		
Example of Parameter Adjustment . . . . .	10		
Alarms . . . . .	10		
Alarm Descriptions. . . . .	11		
Menu Overview . . . . .	12-13		
Main Menu Overview . . . . .	14-16		
Menus			
A.  On/Off Unit . . . . .	16		
B.  Set point . . . . .	17-23		
C.  Clock/Scheduler . . . . .	24		
D.  Input/Output . . . . .	24		
E.  Data Logger . . . . .	25		
F.  Board Switch. . . . .	25		
G.  Service			
a. Information. . . . .	25		
b. Overrides . . . . .	25-27		
c. BMS Config . . . . .	27-28		
d. Service Settings			
a. Working hour set . . . . .	29		
b. Probe adjustment. . . . .	29		
c. Password/Defaults . . . . .	29		
e. Commissioning			
a. Furnace Commissioning . . . . .	29		
H.  Manufacturer			
a. Configuration . . . . .	30		
b. I/O Configuration . . . . .	31		
c. Factory Settings . . . . .	31-37		
d. Initialization . . . . .	37		



The microprocessor controller can be configured for air handler, energy recovery, dedicated outdoor air system and make-up air applications. Each application utilizes similar technologies for heating and cooling: chilled water, hot water, indirect gas, electric heat, packaged DX cooling, and packaged DX cooling with digital scrolls. All set points, lockouts and delays are user adjustable via the integral keypad display.

### General Operation

**UNIT START COMMAND:** The microprocessor controller requires a digital input to enable operation. The unit can then be commanded on or off by this digital input, the BMS or internal time clock.

- Initial delay
- Factory mounted and wired dampers are powered, *if equipped*. (Outdoor air, exhaust air, and recirculation air dampers).
- Exhaust fan and energy recovery wheel start after a 10 second delay, *if equipped*.
- Supply fan starts 15 seconds after the exhaust fan.
- Tempering operation begins (reference tempering)

### UNIT STOP COMMAND (OR DE-ENERGIZED):

- Supply fan, exhaust fan (*if equipped*), tempering, and wheel are de-energized.
- Outdoor air and Exhaust air dampers are closed after a 10 second delay. Recirculation air dampers spring open.

**OCCUPIED/UNOCCUPIED MODES:** The microprocessor controller offers three modes of determining occupancy: a dry contact, the internal time clock or the BMS. When in the unoccupied mode, the unit can be configured to shut down, or cycle on to maintain the unoccupied room set points. The unit can be temporarily overridden to the occupied mode via a digital input or the keypad display.

The internal time clock can be configured with morning warm-up to bring the space to the occupied set point prior to occupancy.

- **Occupied Mode:**
  - Exhaust fan on, *if equipped*
  - Supply fan on
  - Heating (refer to Heating section)
  - Cooling (refer to Cooling section)
  - Energy Recovery Wheel control (refer to Energy Recover Wheel section), if equipped.
  - Damper control (refer to Outdoor Air and Recirculated Air section), if equipped.
- **Unoccupied Mode (Unit Off):** Unit remains off when in unoccupied mode.
- **Unoccupied Mode (Cycle on Room):** Optional unoccupied mode when there is an unoccupied recirculation damper and room temperature and/or humidity sensor(s) connected to the controller. The unit will cycle on to maintain unoccupied room set points if there is a call for unoccupied heating, cooling or dehumidification.

- Exhaust fan off, *if equipped*.
- Supply fan off.
- Recirculation air damper open.
- OA damper closed.
- Tempering operations begin (reference tempering)

---

### Set Point Control (Occupied)

Supply air temperature set point can be configured as constant, or can be reset by either outside air temperature, or room temperature set point. If equipped with BMS communications, the user can also directly command the supply temperature set point, or room temperature set point (if equipped with an optional room temperature sensor).

- **Outdoor Air Temperature Reset Function:** The controller will default to supply temperature reset based on outdoor air temperature. The controller will monitor the OA temperature and reset the supply temperature set point based upon the outdoor air reset function.
- **Room Temperature Reset (optional):** With a room temperature sensor, the controller will adjust the supply air temperature set point between the minimum (55°F) and maximum (90°F), to satisfy the desired room temperature.

---

### Set Point Control (Unoccupied)

When equipped with an unoccupied recirculation damper and optional room temperature and/or humidity sensors, the unit will cycle on to maintain the unoccupied room set points.

- **Unoccupied Heating:** If equipped with heating, the unit is enabled when the room temperature is less than the unoccupied heating set point minus differential (65°F-5°F). The supply air temperature set point will be set to the supply maximum reset limit (90°F). The unit cycles off when the room temperature reaches the unoccupied heating set point.
- **Unoccupied Cooling:** If equipped with cooling, the unit is enabled when the room temperature is greater than the unoccupied cooling set point plus differential (80°F+5°F). The supply air temperature set point will be set to the supply minimum reset limit (55°F). The unit cycles off when the room temperature reaches the unoccupied cooling set point.
- **Unoccupied Dehumidification:** If equipped with cooling, the unit is enabled when the room relative humidity exceeds the unoccupied room relative humidity set point plus differential (50%+5%), or when dehumidistat contact indicates excessive humidity. The supply air temperature set point will be set to the equivalent occupied supply set point.

## Sequence of Operation

- **Morning Warm-Up:** The unit uses an algorithm involving space temperature and the heating / cooling rate of the previous day to determine the time required to efficiently temper the space to occupied set point prior to occupancy (optional room temperature sensor is optional).

---

### Heating

The heating is controlled to maintain the supply temperature set point. The heating will be locked out when the outside air temperature is above the heating lockout (70°F adj).

- **Indirect Gas Furnace:** Microprocessor controller will modulate the indirect gas furnace to maintain the supply temperature set point.
- **Hot Water Coil:** Microprocessor controller will modulate a hot water valve (provided by others) to maintain the supply temperature set point. **Coil freeze protection must be provided by others in the field!**
- **Electric Heater:** Microprocessor controller will modulate an electric heater to maintain the supply temperature set point.
- **Heat Pump:** Microprocessor controller will stage compressor(s) to maintain the supply air set point. This signal will come wired to the factory provided heat pump module. **All external water valves and valve controls are provided, wired and mounted by others in the field, including freeze protection.**

---

### Cooling

The cooling is controlled to maintain the supply temperature set point. The mechanical cooling will be locked out when the outside air temperature is below the cooling lockout (55°F).

- **Chilled Water:** Microprocessor controller will modulate a chilled water valve (provided by others) to maintain supply air set point. **Coil Freeze protection must be provided by others in the field!**
- **Packaged/Split DX Cooling (Standard Scroll):** Microprocessor controller will enable stages of cooling to maintain the supply air set point.
- **Packaged DX Cooling (Digital Scroll):** Microprocessor controller will modulate the digital scroll to maintain the supply air temperature set point.
- **Heat Pump:** Microprocessor controller will power the reversing valve within the heat pump module to direct the refrigerant flow for airside cooling. The cooling is controlled to maintain the supply temperature set point. **All external water valves and valve controls are provided, wired and mounted by others in the field, including freeze protection.**

### Economizer

If the application requires cooling, and the outdoor air conditions are suitable for free cooling, the controller may enter the economizer state. If the unit is economizing and the discharge temperature set point is not being met, the controller may bring on mechanical cooling. If equipped with a modulating outdoor air and recirculated air damper, the dampers will modulate between the minimum OA and maximum positions to maintain the supply temperature set point. If equipped with an energy wheel, see Energy Recovery Wheel Sequence.

- **Temperature:** The economizer will be locked out when:
  - The outside air is less than the economizer low lockout (40°F).
  - The outside air is greater than the economizer high lockout (65°F).
  - The unit is operating in dehumidification mode.
  - There is a call for heating.
- **Temperature/Dew Point:** The economizer will be locked out when:
  - The outside air is less than the economizer low lockout (40°F dry-bulb).
  - The outside air is greater than the economizer high lockout (75°F dry-bulb).
  - The outside air is greater than the economizer high dew point lockout (55°F dew point)
  - The unit is operating in dehumidification mode.
  - There is a call for heating.

---

### Dehumidification

The cooling is controlled to maintain the cold coil set point. The dehumidification sequence will be locked out when the OA is less than the dehumidification lockout (10°F) above the cold coil set point. If equipped with BMS communications, the user can also directly set the cold coil leaving air set point.

- **Optional Room Dehumidistat:** The room dehumidistat is a field mounted sensor that monitors the relative humidity (RH) of the room. If the RH exceeds set point, the dehumidistat will reset the cold coil set point to the minimum (50°F). Once the room dehumidistat is satisfied, the cold coil set point will return to the maximum (55°F).
- **Optional Room Relative Humidity Sensor:** The controller will adjust the cold coil leaving air temperature set point between the minimum (50°F) and maximum (55°F) set points, to satisfy the desired room relative humidity set point.

## Reheat

While the unit is in dehumidification mode, the supply air can be reheated via Primary Heating Source, On/Off Hot Gas Reheat or Modulating Hot Gas Reheat.

- **Primary Heating Source:** The main heating source is enabled to reheat the air to meet the supply temperature set point. (Except heat pump). The primary heat source may also be configured to act as secondary reheat.
- **Modulating Hot Gas Reheat (valve):** The microprocessor controller will modulate the hot gas reheat valve to maintain the supply temperature set point.

---

## Supply Fan VFD Sequence

If the factory has installed a VFD and wired it to the controller, it is intended to operate at a constant speed during operation. This speed needs to be set during test and balance of the unit. If equipped with BMS communications, the user can also directly command the supply fan speed.

- **Optional Room/Duct CO2 Sensor:** The controller will modulate the supply fan based upon a comparison of the CO2 set point to the actual CO2 levels reported from the sensor.
- **Optional Duct Static Pressure Sensor:** The controller will modulate the supply fan based upon a comparison of the duct static pressure set point to the actual duct static pressure level reported from the sensor.
- **Optional Building Static Pressure Sensor:** The controller will modulate the supply fan based upon a comparison of the building static pressure set point to the actual building static pressure level reported from the sensor.
- **Optional Single Zone VAV (SZ):** The controller will control the supply air temperature and supply fan speed to maintain the room temperature set point. This sequence requires a room temperature sensor.
  - Heating** - When the room requires heating, the controller will reset the supply air temperature set point up to the maximum (90°F) while increasing the supply fan speed up to its maximum heating speed.
  - Cooling** - When the room requires cooling, the controller will first reset the supply air temperature set point down to the minimum (55°F) while the supply fan remains at the minimum cooling speed. After a time delay, the supply fan speed will increase up to its maximum cooling speed to maintain the room temperature set point.

## Exhaust Fan VFD Sequence

If the factory has installed a VFD and wired it to the controller, it is intended to operate at a constant speed during operation. This speed needs to be set during test and balance of the unit. If equipped with BMS communications, the user can also directly command the exhaust fan speed.

- **Optional Building Static Pressure Sensor:** The controller will modulate the exhaust fan based upon a comparison of the building static pressure set point to the actual building static pressure level reported from the sensor.
- **Optional Supply Fan Tracking:** The controller will proportionally modulate the exhaust fan based upon the supply fan speed.
- **Optional Outdoor Air Damper Tracking:** The controller will proportionally modulate the exhaust fan based upon the outdoor air damper position.

---

## Outdoor Air and Recirculated (Recirc) Air Damper Control

If equipped with a modulating outdoor air and recirculated air damper, the recirculated air damper will operate inverse of the outdoor air damper. The outdoor air damper will open to a Minimum Outdoor Air Position (Min OA) when in occupied mode. If the controller is configured to modulate the supply fan speed, the minimum and maximum OA positions can be reset based on supply fan speed. If equipped with BMS communications, the user can also directly reset the damper position up to the maximum OA position.

- **Optional Room CO2 Sensor:** The controller will proportionally modulate the OA/RA dampers based upon a comparison of the CO2 set point to the actual CO2 level reported from the sensor. As the CO2 level rises, the controller will proportionally modulate the outdoor air damper open, between the minimum and maximum OA position.
- **Optional Building Pressure:** The OA/RA dampers will modulate based upon the signal from a building static pressure sensor. The controller will modulate the dampers, between the minimum and maximum OA positions, based upon a comparison of the building static pressure set point to the actual building static pressure level reported from the sensor.

## Energy Recovery Wheel Sequences

**Economizer (optional):** If the unit is equipped with an energy recovery wheel, the economizer will modulate/stop the energy wheel to achieve free cooling.

- **Stop Wheel:** When economizer mode is enabled and there is a signal for cooling, the wheel will stop rotating to allow free cooling.
- **Modulate Wheel:** When economizer mode is enabled and there is a signal for cooling, the controller modulates wheel speed to maintain the supply temperature set point.
- **Energy Wheel Bypass Dampers (optional):** During normal operation, the dampers shall remain closed to allow full operation of the energy wheel. During economizer sequences, the dampers will be open to bypass the energy wheel.

**Frost Control (optional):** The microprocessor controller will activate the frost control method when the outdoor air temperature is less than the defrost set point (5°F) and the wheel pressure switch is closed, due to a high wheel pressure drop. Once either the pressure drop decreases below the pressure switch point, or the outdoor air temperature increases, the unit will resume normal operation.

- **Electric Preheater:** When frosting is occurring, the preheater is energized to defrost the wheel.
  - **Modulate Wheel:** When frosting is occurring, the wheel slows to allow defrosting to occur.
  - **Cycle Wheel:** When frosting is occurring, the energy wheel is cycled off for a defrost cycle time (2 minutes). After the defrost cycle time, the wheel is re-energized to continue normal operation. The controller will not allow another defrost cycle for a minimum normal operating cycle time (5 minutes).
  - **Timed Exhaust:** When frosting is occurring, the supply fan is cycled off along with the tempering for a defrost cycle time (5 minutes). The exhaust fan will continue to run, allowing the warm exhaust air to defrost the wheel. After the defrost cycle time, the supply fan and tempering are re-energized to continue normal operation. The controller will not allow another defrost cycle for a minimum normal operating cycle time (30 minutes).
- 

## Alarms

The microprocessor controller includes a digital output for remote indication of an alarm condition, which connects via the **J15** port. Possible alarms include:

- **Dirty Filter Alarm:** If the outside air or return air filter differential pressure rises above the differential pressure switch set point, the microprocessor controller will activate an alarm.
- **Supply and Exhaust Air Proving Alarm:** Microprocessor controller monitors proving switch on each blower and displays an alarm in case of blower failure.
- **Sensor Alarm:** Microprocessor controller will send an alarm if a failed sensor is detected (temperature, pressure, relative humidity).
- **Supply Air Low Limit:** If the supply air temperature drops below the supply air low limit (35°F), the microprocessor controller will de-energize the unit and activate the alarm output after a preset time delay (300s).
- **Other Alarms:** Wheel Rotation, High Wheel Pressure, High/Low Refrigerant Pressure.

## pCOe - 4:1 Furnace Overview

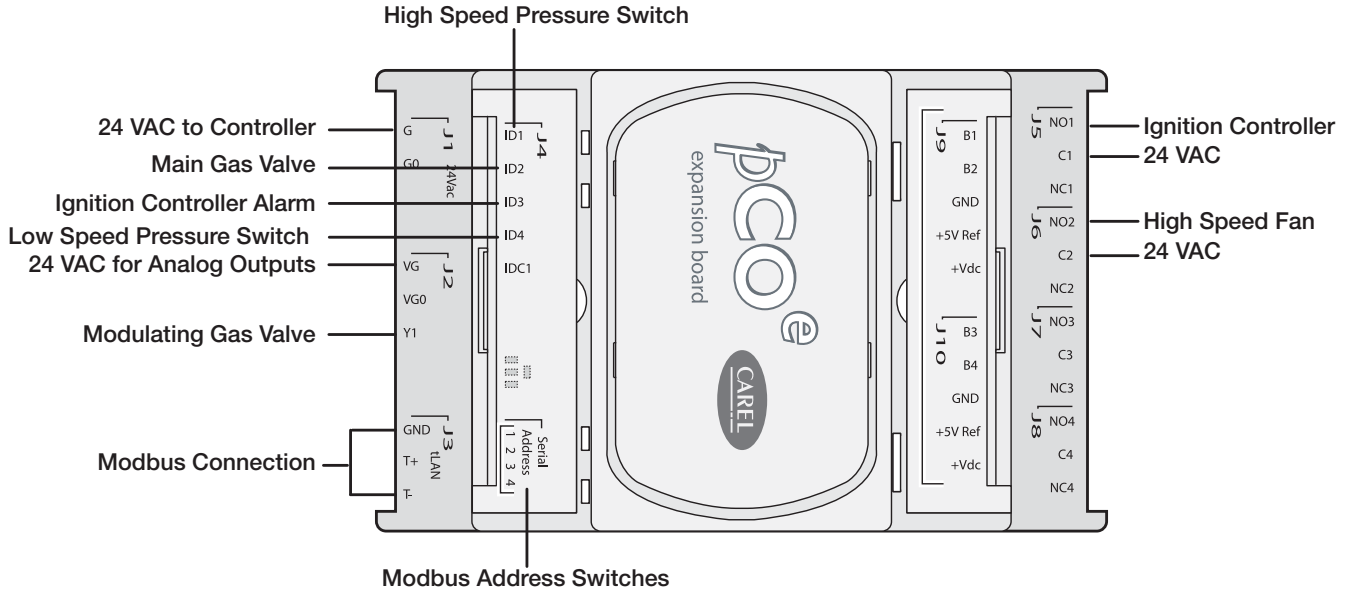

## pCOe - High Turndown Furnace

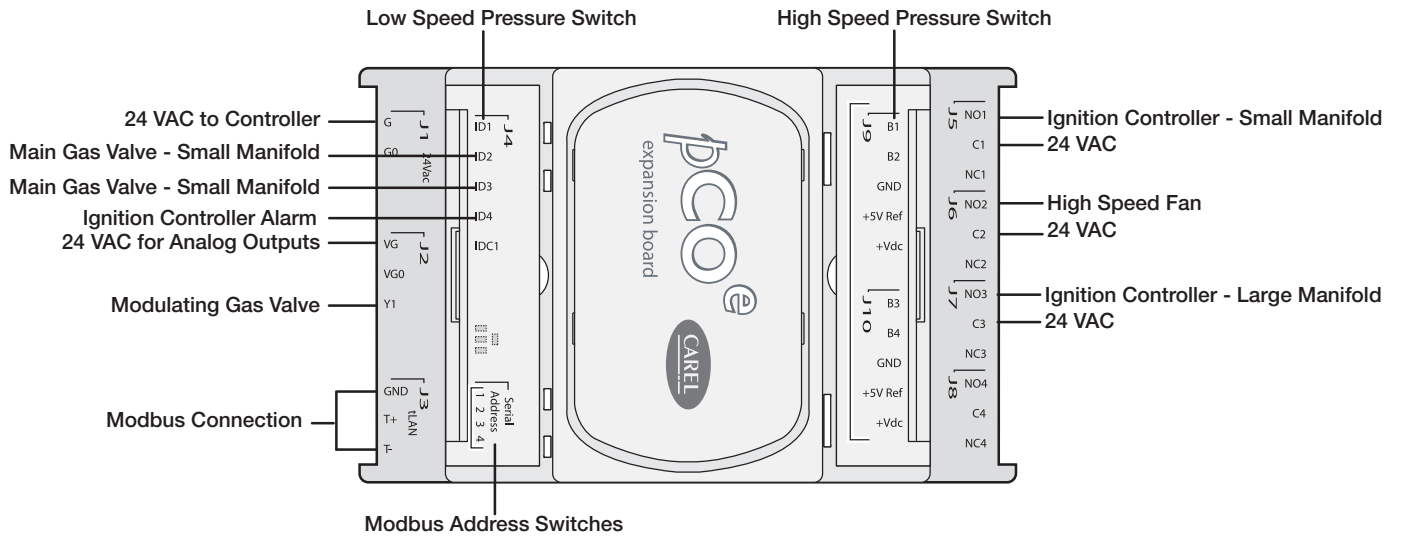

# Large Controller Overview

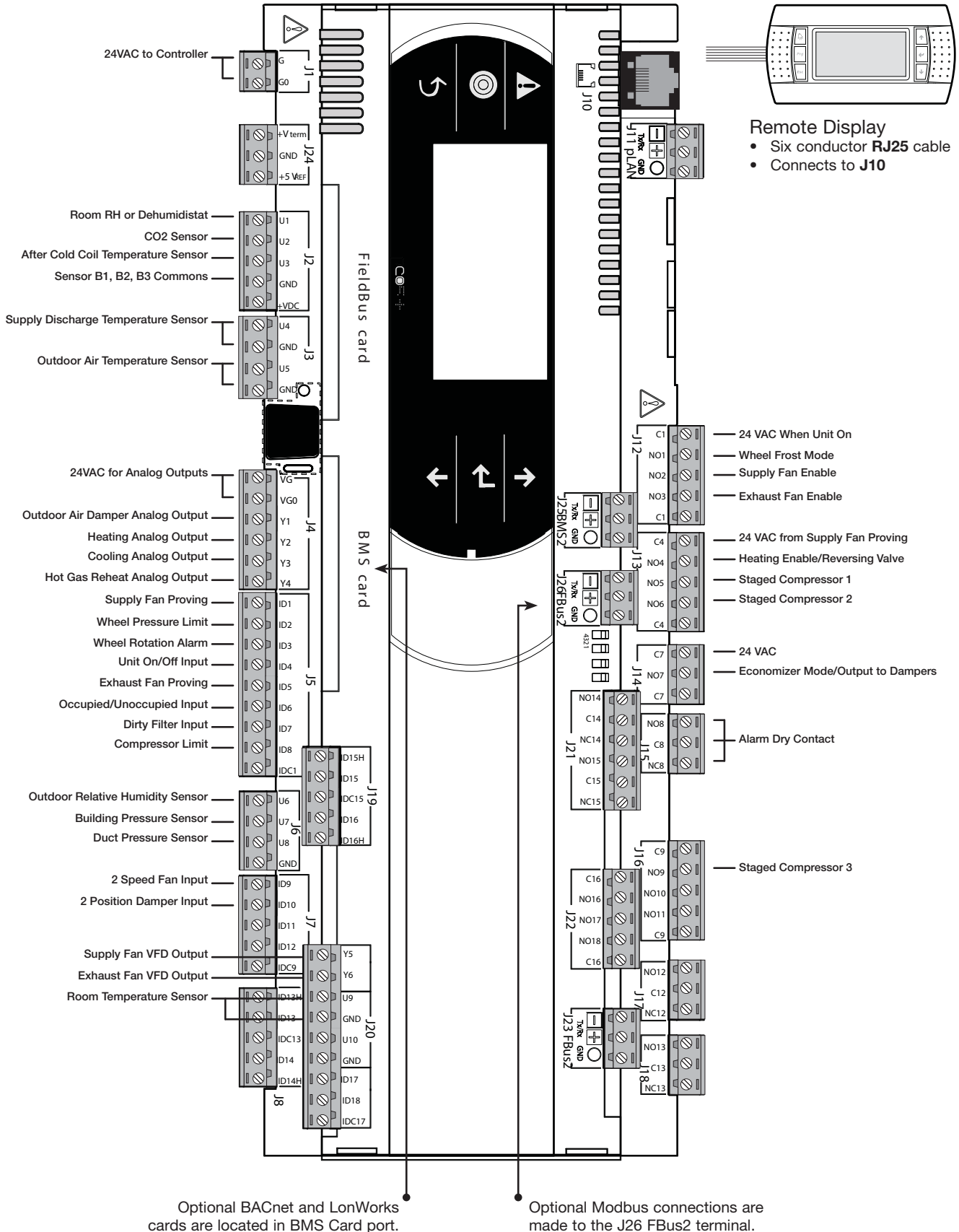



## Small Controller Overview

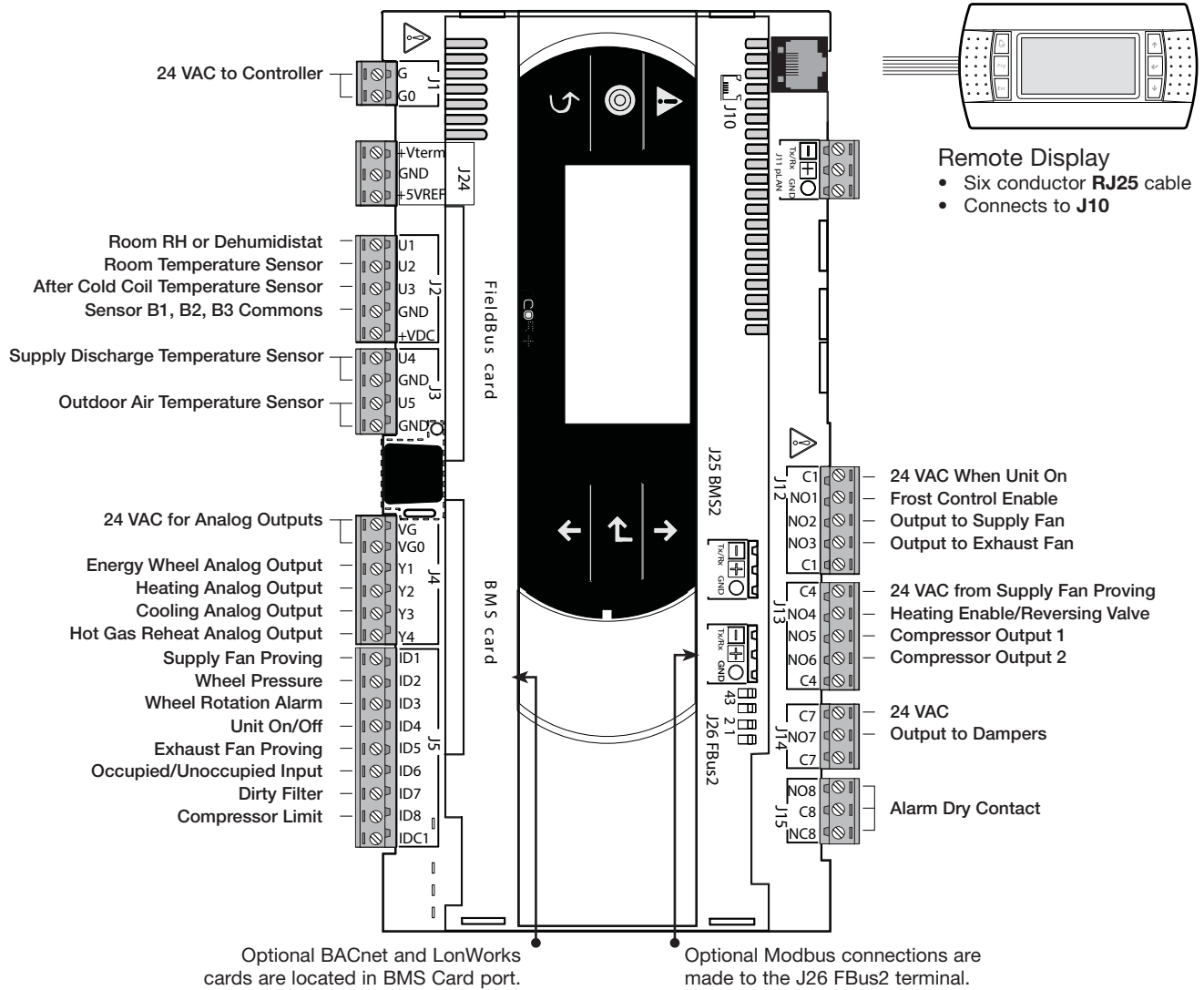

## Display Use

The microprocessor controller is located in the unit control center. The face of the controller has six keys, allowing the user to view unit conditions and alter parameters. The microprocessor controller is pre-programmed with easy to use menus. To change the display contrast, hold the Enter and Escape button while pressing the up and down arrows. A remote display is also available, which connects via the **J10** port. A six wire patch cable is needed.

### Keypad Description

Keypad Description		
	Alarm	Button will blink red, indicating an alarm condition. Press to review current alarms. To review previous alarms, access the DATA LOGGER through the main menu.
	Down Arrow	The arrow keys allow the user to scroll through different screens and adjust parameters.
	Up Arrow	
	Enter	A. In screens with adjustable parameters, pressing the Enter key moves the cursor from the upper left corner of the screen to the parameter. The arrow keys can then be used to adjust the parameter. B. To move to the next parameter on the same screen, press the Enter button. C. To save the change, press the Enter button until the cursor moves back to the upper left corner of the screen.
	Escape	Allows the user to exit the current menu, jumping to the Main Menu.
	Program	Pressing the Prg (Program) button allows the user to enter the Main Program Menu. Refer to pages 10 and 11 for Main Program Menu description.

## Example of Parameter Adjustment

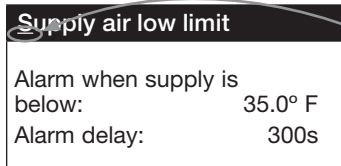

The cursor always begins in the upper left corner of the display and will be blinking. Press the key to move the cursor down for parameter adjustment.

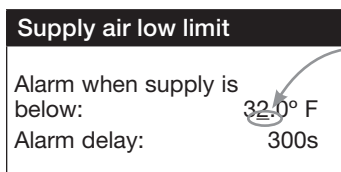

Once the cursor has reached the desired parameter, press the keys to adjust the value.

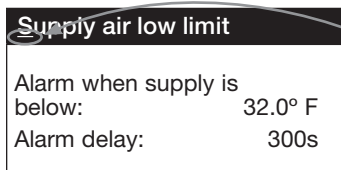

When satisfied with the adjustment, press the key to save the parameter. When finished, make certain the cursor is in the upper left corner. If the cursor is not in the upper left corner, the changes will not be saved. The cursor must be in the upper left corner to enable screen advancement.

## Alarms

If an alarm occurs, the button will glow red on the controller and the remote display (if installed).

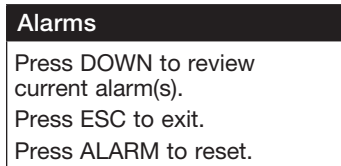

To view alarm, press the button once. This will display the most recent alarm. Press the button again to reset the alarm. If the alarm cannot be cleared, the cause of the alarm has not been fixed. Press the buttons to view any additional occurring alarms.

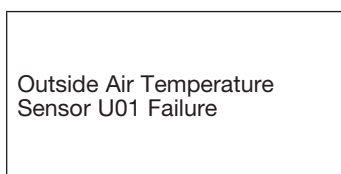

This is an example of an outdoor air sensor failure.



This screen appears if there are no active alarms.

To view all saved alarms, press the button to enter the data logger. For more information, see the Data Logger menu.

<b>Unit Alarm Descriptions</b>		
Outdoor air temperature sensor failure	Failure of outside air temperature sensor.	Alarm only
Supply air temperature sensor failure	Failure of supply air temperature sensor.	Alarm & Shutdown
Cold coil temperature sensor failure	Failure of after cooling coil air temperature sensor.	Alarm only
Room temperature sensor failure	Failure of room temperature sensor. (If Unoccupied - Cycle On Room is enabled)	Alarm only
System has exceeded the set number of run hours	The unit has been operating for a period longer than the maintenance set point.	Alarm only
Supply airflow	Indicates a loss of airflow in the supply fan.	Alarm & Shutdown
Wheel pressure - Dirty wheel/high cfm	Indicates a buildup of pressure across the energy wheel.	Alarm only
Energy recovery wheel rotation. Check wheel.	Indicates a wheel rotation failure.	Alarm only
Exhaust airflow	Indicates a loss of airflow in the exhaust fan.	Alarm & Shutdown
Filter alarm	Indicates a buildup of pressure across the filters.	Alarm only
A compressor limit switch has tripped	Indicates a high or low refrigerant pressure switch has tripped.	Alarm only
Supply temperature low limit alarm	Indicates a supply air temperature lower than the supply low limit set point.	Alarm & Shutdown
Cold coil low limit	Indicates a cold coil temperature lower than the cold coil low limit	Alarm & discharge air sensor lockout
pCOe offline	Indicates communication with pCOe auxiliary I/O has failed.	Alarm only
pCOe - Analog input probe on channel # disconnected or broken	Indicates an analog probe failure on the pCOe. Check integrity of auxiliary I/O analog probes.	Alarm only
Building pressure sensor failure	Failure of building pressure sensor	Alarm & minimum fan speed
Duct pressure sensor failure	Failure of duct pressure sensor	Alarm & minimum fan speed
Room humidity sensor failure	Failure of room RH sensor	Alarm only
Outdoor air humidity sensor failure	Failure of outdoor air humidity sensor	Alarm only
CO2 sensor failure	Failure of CO2 sensor	Alarm & minimum fan speed
Modbus T-Stat offline	Failure of a room Modbus T-Stat	Alarm only
<b>Furnace Alarm Descriptions</b>		
IG furnace no flame after three trials	Indicates a furnace failure to light or properly sense flame after 3 trials.	Alarm only
IG combustion fan high pressure switch failure	Indicates a call for high speed combustion fan but high pressure switch did not close.	Alarm only
IG furnace ignition control	Indicates an alarm from the ignition controller.	Alarm only
Pressure switch closed with combustion fan off	Indicates low pressure switch was closed with no call for combustion fan.	Alarm only
Combustion fan not proved	Indicates a call for low speed combustion fan but low pressure switch did not close.	Alarm only
IG furnace max retry	Indicates that the max number of retries was reached.	Alarm and Furnace lockout
High temp. alarm	Indicates that power was lost from the High Temp Limit Sensor. Check for high limit trip.	Alarm only
IG furnace offline	Indicates communication with furnace control has failed.	Alarm only
IG LG Man No Flame AL	No flame after 3 trials for ignition on the large manifold.	Alarm only
Combustion Fan Error	Indicates the high and low pressure switches both dropped out while the call for heat was still enabled to the furnace.	Alarm only

## Menu Overview

Press  to enter menus.

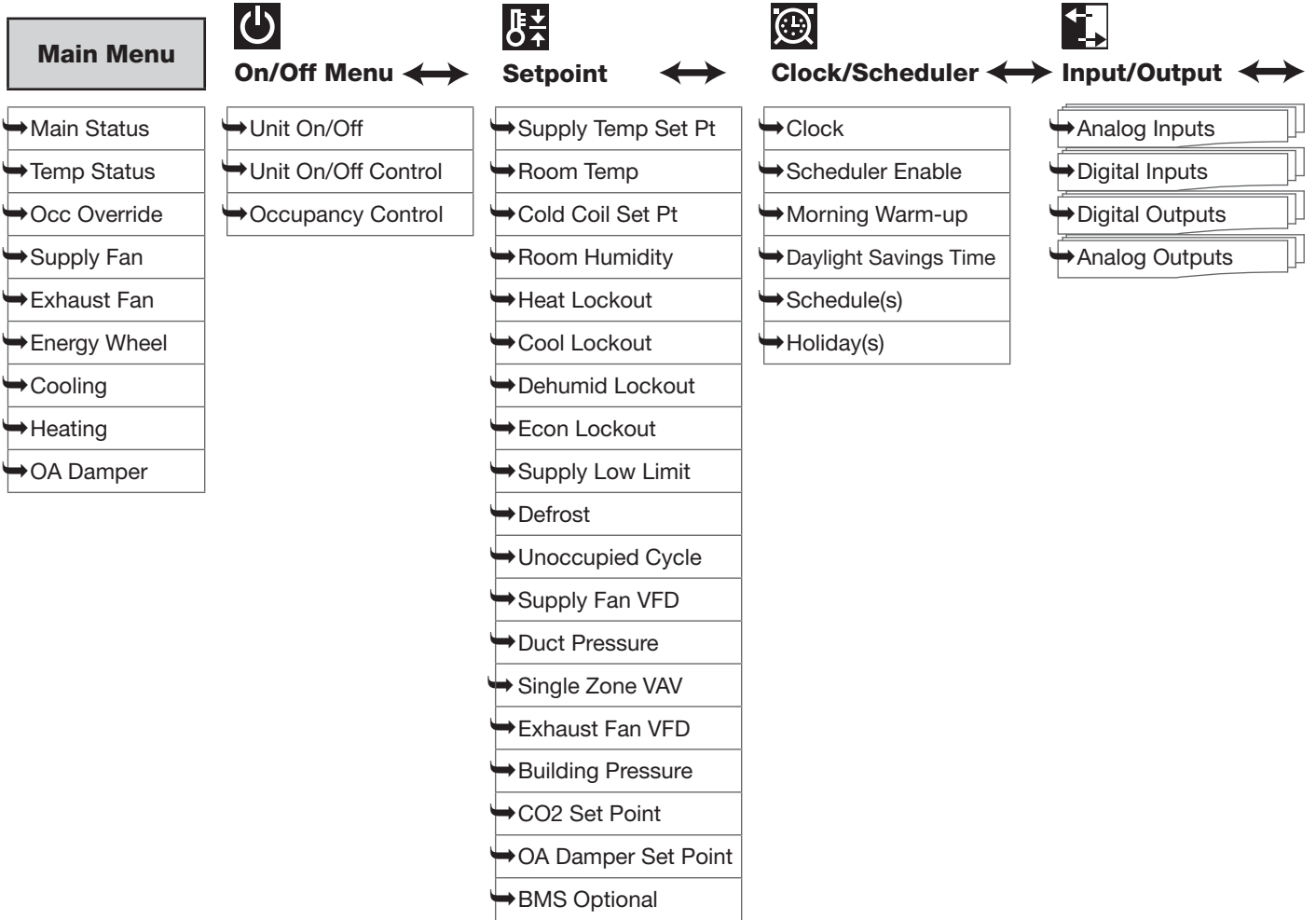

### NOTE

Your controller may not show all menus depending on unit configuration.

# Menu Overview

Press  to enter menus.



**Data Logger**

→ Alarms



**Board Switch**

→ Board Switch Set



**Service**

Information

→ Information

→ Information2

Overrides

→ Analog Inputs

→ Digital Inputs

→ Relay Outputs

→ Analog Outputs

→ Control Loops

BMS Config

→ Protocol

→ Modbus

→ BACnet MSTP

→ BACnet TCP/IP

→ BACnet TCP/IP

→ BACnet R/W

Service Settings

Working Hours

→ Maintenance Hours

Probe Adjustment

→ Analog Inputs

Password/Default

→ Service Password

→ Service Restore

→ Prg Menu Lock

Commissioning

→ Furnace Commissioning



**Manufacturer**

Configuration

→ Unit Code

→ Expansion I/O

→ pLAN Comm

→ Field Card Comm

I/O Config

→ Inputs/Outputs

Factory Settings

→ Economizer

→ Defrost Cycle

→ Cooling Control

→ Comp Rotation

→ Digital Scroll

→ Comp Timers

→ Comp Staging

→ Heat Control

→ Heater Reheat

→ IG Heater

→ Hot Gas Control

→ Hot Gas Timers

→ Hot Gas Setup

→ SA Reset Control

→ Heat/Cool Delay

→ Damper Delay

→ Unocc Setup

→ Damper Delay

→ Air Proving

→ Fan Delay

→ Rotation Delay

→ CO2 Control

→ Duct Pressure

→ Building Pressure

→ Units / Display



Initialization

→ Manf Restore

→ Manf Password

→ Factory Restore

## Main Menu Overview

The microprocessor controller will revert to a default main menu loop. This loop includes several screens to view the operating conditions of the unit. Scroll through the menu screens by using the   keys. **Screens with a dashed line border are dependent upon an optional accessory and may not always appear.**

TIME	DATE	UNIT##
 <i>Building Value in Air.</i>		
TAP v2.50 GWY1X000XXXX		
STATUS LINE		

**THE INITIAL MENU SCREEN DISPLAYS THE PROGRAM VERSION, UNIT CODE AND STATUS LINE. THE STATUS LINE DISPLAYS WHICH MODE THE UNIT IS IN.**

Possible modes include:

- Initial Delay
- Opening Dampers
- Exhaust Fan Starting
- Supply Fan Starting
- System On
- Defrost Mode Active
- Sys On - Econ+Cooling
- Sys On - Economizer
- Sys On - Heating
- Sys On - Cooling
- Sys On - Dehumidifying
- Sys On - Dehumid & Reheat
- Unoccupied - Unit On
- Unoccupied - Unit Off
- Unoccupied - Dehumid
- Unoccupied - Dehumid & Reheat
- Unoccupied - Heating
- Unoccupied - Cooling
- Manual Override
- Remote Off
- Press Alarm Button!!!
- Temp Occupied

TIME	DATE	UNIT##
Supply Air:		000.0°F
Outside Air:		000.0°F
OA Humidity		00.0%
Cold Coil:		000.0°F
Room Temp:		000.0°F
Room Humidity:		00.0%
STATUS LINE		

**THE SENSOR STATUS SCREEN DISPLAYS REAL TIME CONDITIONS FROM THE SENSORS LOCATED IN THE UNIT AND THE ROOM (IF INSTALLED).**

Occupancy Override	
Clock Override:	OFF
Override Time:	1 hr

**OCCUPANCY OVERRIDE (IF UNOCCUPIED)**

If the unit is currently unoccupied, the occupancy can be temporarily overridden for a period of override time. The override time parameter can be set from one to three hours.

Supply Fan Status	
Supply Fan Ramp:	0%
(0%=Min Speed by VFD)	
Duct Ps Control	
Duct Pressure:	0.00"wc
STATUS LINE	

**SUPPLY FAN STATUS (IF EQUIPPED WITH VFD)**

If equipped with a supply fan VFD, this screen will display the supply fan ramp being sent from the controller to the VFD. The minimum and maximum speeds are set in the VFD (See unit Installation and Operation Manual for VFD programming). The controller can modulate the fan between the min and max speeds via an analog output. This screen also displays the method of fan control and the parameter it is controlling.

Possible methods include: constant speed, duct pressure control, building pressure control, CO2 control, and single zone VAV.

Exhaust Fan Status	
Exhaust Fan Ramp:	0%
(0%=Min Speed by VFD)	
Building Ps Control	
Building Ps:	+0.00"wc
STATUS LINE	

**EXHAUST FAN STATUS (IF EQUIPPED WITH VFD)**

If equipped with an exhaust fan VFD, this screen will display the exhaust fan ramp being sent from the controller to the VFD. The minimum and maximum speeds are set in the VFD (See unit Installation and Operation Manual for VFD programming). The controller can modulate the fan between the min and max speeds via an analog output. This screen also displays the method of fan control and the parameter it is controlling.

Possible methods include: constant speed, building pressure control, outdoor air damper tracking, and supply fan tracking.

Energy Recovery	
Wheel:	100% Speed
Wheel Differential	
Pressure Is:	Normal
Preheater:	OFF
STATUS LINE	

**ENERGY RECOVERY WHEEL STATUS (IF EQUIPPED)**

If selected with a preheater, the status will also be displayed.



Cooling Status	
Cooling Control:	000%
Compressor	D 1 2
STATUS LINE	

Heating Status	
Heater Control:	000%
Hot Gas Reheat:	000%
Staged reheat is:	ON
Compressor:	1 2
STATUS LINE	

---

**COOLING STATUS IS DISPLAYED, ALONG WITH COMPRESSOR OPERATION. (IF EQUIPPED)**

---

*This screen appears if a cooling option is provided.*

**Chilled Water:** The cooling control percent is directly proportional to the 0-10 VDC output signal.

- 0% Cooling = 0 VDC
- 100% Cooling = 10 VDC

The cooling control output can be configured to direct/reverse acting, along with the minimum and maximum output voltages by entering the manufacturer menu.

**Packaged DX Cooling:** The cooling control displays internal cooling ramp as a percent. Compressor operation is displayed when engaged.

- D = Digital scroll compressor operation
- 1 = First staged compressor operation
- 2 = Second staged compressor operation
- 3 = Third staged compressor operation
- 4 = Fourth staged compressor operation

**Heat Pump Cooling:** The cooling control displays internal cooling ramp as a percent. Compressor operation is displayed when engaged.

- 1 = First staged compressor operation
- 2 = Second staged compressor operation

---

**HEAT AND REHEAT OPERATION IS DISPLAYED. (IF EQUIPPED)**

---

Heater control displays the proportional percentage of the heater analog output.

**Electric Heater:** The heater control percent is proportional to the 0-10 VDC signal being sent to the SCR controller, located in the electric heater control center.

- 0% Heating = 0 VDC - 0 kW output
- 100% Heating = 10 VDC - Max kW output

**Hot Water:** The heater control percent is proportional to the 0-10 VDC signal being sent to the heating control valve (by others). The heating control output can be configured to direct/reverse acting, along with the minimum and maximum output voltages by entering the manufacturer menu.

- 0% Heating = 0 VDC
- 100% Heating = 10 VDC

**Indirect Gas:** The heater control percent is proportional to the 0-10 VDC signal being sent to the indirect gas furnace controller, located in the indirect gas control center. The first stage is on at 1% heater control. The furnace will then modulate proportionally from minimum to maximum capacity.

- 0% = 0 VDC – Off
- 1% = 0 VDC – Minimum turndown enabled
- 1 - 100% = 0 - 10 VDC = Furnace modulation

**Heat Pump Heating:** The heater control percent displays internal heating ramp as a percent. Compressor operation is displayed when engaged.

- 1 = First staged compressor operation
- 2 = Second staged compressor operation

**Hot Gas Reheat:**

*If hot gas reheat is modulating valve control:*

- 0% = Off
- 1% - 100% = 0 - 10 VDC = Hot gas reheat valve modulation

Outdoor Damper Status	
Damper Position:	50%
Active on Minimum	OA%
CO2 Level:	0PPM
STATUS LINE	

Airflow Measurement	
Outdoor Air:	0cfm
Exhaust Air:	0cfm
More Information	

Outdoor Airflow	
Avg. Airflow:	0cfm
Avg. Temp:	0.0°F
Duct Area:	0.0 sq ft
Alarm:	None
Trouble:	No
Offline:	No
Address:	31

### OUTDOOR AIR DAMPER STATUS (IF EQUIPPED WITH MODULATING OUTDOOR AND RECIRCULATED AIR DAMPERS)



This screen will display the outdoor air damper position commanded by the controller and which method the damper position is actively utilizing.

Possible methods include: active on minimum OA%, active on economizer, active on CO2 and active on BMS.

### AIRFLOW MONITORING (IF EQUIPPED)

This screen will display the different unit airflows that were selected to be monitored in the unit. The "More Information" selection can be used to change the airflow monitor setup. For more information see *Appendix C: GreenTrol Quick Start*.

## Menus

The controller is equipped with several menus to help guide users with altering program parameters. The following menus can be accessed by pressing the  key. To enter the desired menu, press the  key.

### A. On/Off Unit

The **On/Off Unit** menu allows the user to view the detailed On/Off status of the controller.

Unit On/Off	
Actual state:	Off by DIG INPUT (ID4)
Change to:	SWITCH ON
*Power ID4 to start...	

The unit ships from the factory in a disabled state. To allow the unit to operate, the controller must receive a run command from digital input ID4. **Jumper unit terminals R - G to allow the unit to operate.**

**Actual State:** The controller may be in following On/Off states:

- Unit on - Unit is on, functioning normally.
- Off by alarm - Unit is off due to an alarm. View alarms by pressing ALARM button.
- Off by pLAN - Unit is off by pLAN network.
- Off by BMS - Unit is off by BMS command
- Off by unoccupied - Unit is off by unoccupied command.
- Off by digital input (ID4) - Unit is off by digital input 4 (ID4).
- Off by keypad - Unit is commanded off by this screen.

**Change to (Switch Off/Switch On):** Enables user manually turn unit on/off via display. Unit terminal **G** must have 24 VAC power to enable the unit.

Unit ON/OFF Control	
Enable unit OnOff	
By digit input:	Yes
By BMS:	No

**THIS SCREEN ALLOWS THE USER TO ADJUST WHICH SYSTEM CONTROLS THE UNIT ON/OFF STATE.**

**Digital Input:** Default to yes. Unit terminal G must have 24 VAC power to enable the unit.

The user can also use the BMS or internal time clock to command the unit on/off state. If scheduling is desired, go to the clock/scheduler menu to set a schedule.

**BMS:** Yes allows BMS to control unit on/off state.

Occupancy Control	
Type:	Unit OFF
Source:	Input ID6

**THIS SCREEN DISPLAYS WHAT THE UNIT WILL DO IN UNOCCUPIED MODE.**

This screen allows the user to select the source of determining occupancy. The factory default is terminal ID6 on the controller.

**Input ID6:** Typically used with a remote time clock, motion sensor or switch (default).

**BMS:** BMS control (see points list). BMS can be overridden with ID6.

**Time Clock:** Internal time clock (scheduler). See clock/scheduler menu for more information. The scheduler can be overridden with digital input ID6.



## B. Set point

The **Set point** menu allows the user to view and adjust temperature related parameters.

### Supply Temp Set Point

Active StPt:	70.0°F
Supply Temp:	69.8°F
Source: Local	70.0°F
Max:	90.0°F
Min:	55.0°F

### Supply Temp Set Point

Active StPt:	72.0°F
Supply Temp:	71.8°F
Source: BMS	72.0°F
Max:	90.0°F
Min:	55.0°F

### Supply Temp Set Point

Active StPt:	55.0°F	
Supply Temp:	54.8°F	
Source: OA Reset		
Outside	--->	Supply
55.0°F	--->	70.0°F
65.0°F	---	55.0°F

### Supply Temp Set Point

Active StPt:	72.0°F
Supply Temp:	71.8°F
Source: Room Reset	
Max:	90.0°F
Min:	55.0°F

### Room Temp Set Point

Active StPt:	72.0°F
Supply Temp:	71.8°F
Source: Local	72.0°F

### Room Temp Set Point

Active StPt:	72.0°F
Supply Temp:	71.8°F
Source: BMS	72.0°F

### **THIS SCREEN DISPLAYS THE SUPPLY AIR TEMPERATURE SET POINT SCREEN PARAMETERS.**

When operating, the unit will control the heating and cooling to maintain the active supply temperature set point. The active set point will be determined by the set point source selection.

#### **Possible Set Point Sources:**

**Local** – The supply set point will be constant set from screen. (exp. 72°F).

**BMS** – The BMS can directly control the supply air temperature set point (requires BMS communication option).

**OA-Reset** -The controller monitors the outdoor air temperature and adjusts the desired supply temperature set point accordingly. For example, when the outdoor air is below 55°F, the controller will change the supply set point to 70°F. If the outdoor air is above 65°F, the controller will change the supply set point to 55°F. If the outdoor air temperature is between 55°F and 65°F, the supply set point changes according to the outdoor air reset function. A visual representation of the outdoor air reset function is shown below.

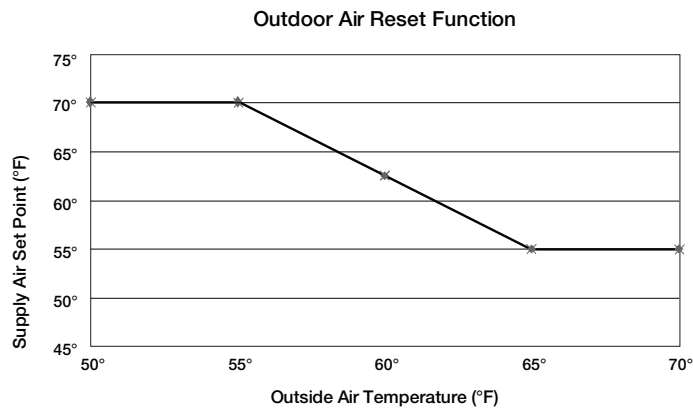

**Room-Reset** – The controller will reset the supply air temperature set point to maintain the room temperature set point (requires room temp sensor). See the Room Temp Set Point screen in this menu for more information.

### **THIS SCREEN DISPLAYS THE ROOM TEMP SET POINT.**

*This screen only appears if Room Reset is selected as the supply set point source, and a room temperature sensor is wired into the controller.*

The unit will reset the supply air temperature set point to maintain the room temp set point.

#### **Possible Set Point Sources:**

**Local** – The room set point will be constant set from screen (exp. 72°F).

**BMS** – The BMS can directly control the room temperature set point (requires BMS communication option).

**T-Stat** – The room set point will be adjustable from the room thermostat. See **Appendix B: Room Thermostat Quick Start** for additional information.

Cold Coil Set Point	
Active StPt:	55.0°F
Cold Coil Temp:	54.8°F
Source: Local	55.0°F
Max:	55.0°F
Min:	50.0°F

Cold Coil Set Point	
Active StPt:	55.0°F
Cold Coil Temp:	54.8°F
Source: BMS	55.0°F
Max:	55.0°F
Min:	50.0°F

Cold Coil Set Point	
Active StPt:	55.0°F
Cold Coil Temp:	54.8°F
Source: Room RH	55.0°F
Max:	55.0°F
Min:	50.0°F

Cold Coil Set Point	
Active StPt:	55.0°F
Cold Coil Temp:	54.8°F
Source: Room DewPt	55.0°F
Max:	55.0°F
Min:	50.0°F

Room Humidity Set Point	
Active StPt:	55.0°F
Cold Coil Temp:	54.8°F
Source: Local	55.0%
Room Humidity:	50.0%

Room DewPt Set Point	
Active StPt:	55.0°F
Cold Coil Temp:	54.8°F
Source: Local	55.0°F
Room Dew Point:	46.0°F

---

**THIS SCREEN DISPLAYS THE TEMPERATURE SET POINTS FOR THE COOLING COIL.**

---

*This screen only appears if the unit is equipped with cooling.*

When in dehumidification mode, the controller will maintain the active cold coil set point. The active set point will be determined by the set point source selection.

**Possible Set Point Sources:**

**Local** – The supply set point will be constant set from screen (exp. 55°F). If a dehumidistat was provided with the unit, the active set point will be reset to the minimum set point.

**BMS** – The cold coil leaving air temperature set point can be adjusted over the BMS via the dehumidification set point (see points list).

**Room RH** – The controller will reset the cold coil temperature set point to maintain the room relative humidity set point (requires room relative humidity sensor). See the room RH set point screen in this menu for more information.

**Room Dew Point** – The controller will reset the cold coil temperature set point to maintain the room dew point set point (requires room temperature and relative humidity sensors). See the room dew point set point screen in this menu for more information.

---

**THIS SCREEN DISPLAYS THE ROOM RELATIVE HUMIDITY SET POINT.**

---

*This screen only appears if room RH is selected as the cold coil set point source, and a room relative humidity sensor is wired into the controller.*

The unit will reset the cold coil temperature set point to maintain the room relative humidity set point.

**Possible Set Point Sources:**

**Local** – The room set point will be constant set from screen (exp. 55% RH).

**BMS** – The cold coil leaving air temperature set point can be adjusted over the BMS via the dehumidification set point (see points list).

---

**THIS SCREEN DISPLAYS THE ROOM DEW POINT SET POINT.**

---

*This screen only appears if room dew point is selected as the cold coil set point source, and a room relative humidity sensor and room temperature sensor are wired into the controller.*

The unit will reset the cold coil temperature set point to maintain the room dew point set point.

**Possible Set Point Sources:**

**Local** – The room set point will be constant set from screen (exp. 55°F)

**BMS** – The cold coil leaving air temperature set point can be adjusted over the BMS via the dehumidification set point (see points list).



### Heating Lockout

Lockout heating when outside above: 70.0°F  
Differential: 2.0°F

### Cooling Lockout

Lockout cooling when outside below: 55.0°F  
Differential: 2.0°F

### Dehumidification lock

Lockout dehumidification until outside air is 10.0°F above cold coil set point.

### Economizer Lockout

Type: DryBulb+DewPoint  
Below: 40.0°F (Dry Bulb)  
Above: 75.0°F (Dry Bulb)  
Above: 55.0°F (Dew PT)  
Differential: 2.0°F

### Supply Air Low Limit

Alarm when supply is below: 35.0°F  
Alarm delay: 300s

### ***THIS SCREEN DISPLAYS THE HEATING LOCKOUT.***

*This screen only appears if the unit the unit is equipped with heating.*

There is a built in hysteresis of 2°F which prevents the heating from short cycling. The hysteresis is similar to a dead-band above and below the lockout set point. (Example: If Lockout = 70°F, heating is locked out above 72°F and enabled below 68°F outside air temperature.)

### ***THIS SCREEN DISPLAYS THE COOLING LOCKOUT.***

*This screen only appears if the unit is equipped with cooling.*

There is a built in hysteresis of 2°F which prevents the cooling from short cycling. The hysteresis is similar to a dead-band above and below the lockout set point. (Example: If Lockout = 55°F, cooling is locked out below 53°F and enabled above 57°F outside air temperature.)

### ***THIS SCREEN DISPLAYS THE TEMPERATURE DIFFERENCE AT WHICH THE DEHUMIDIFICATION MODE IS LOCKED OUT. (FACTORY DEFAULT = 10°F)***

*This screen only appears if the unit is equipped with cooling.*

This setting prevents the unit from operating in dehumidification mode when the outdoor air conditions are relatively cool. Example: If the cold coil set point is 55°F, dehumidification mode cannot operate until the outdoor air is at least 65°F.

### ***THIS SCREEN DISPLAYS THE ECONOMIZER LOCKOUTS.***

*This screen only appears if economizer functionality was provided with the unit.*

The lockouts determine when economizer is available, based on the outdoor air temperature or outdoor air temperature and humidity. The low temperature lockout prevents outdoor air from entering the unit at too cold of a temperature that could freeze coils. There is a built in differential that is similar to a deadband, above and below the lockout set point.

If an outdoor relative humidity sensor was provided with the unit, the user can change the economizer lockout control type.

#### ***Possible Control Types:***

***DryBulb*** – The economizer will be locked out based on the outdoor dry-bulb temperature.

***DryBulb+DewPoint (preferred)*** – The economizer will be locked out based on the outdoor dry-bulb temperature and a calculated outdoor air dew point.

***DryBulb+Enthalpy*** – The economizer will be locked out based on the outdoor dry-bulb temperature and a calculated outdoor enthalpy.

***DryBulb+WetBulb*** – The economizer will be locked out based on the outdoor dry-bulb temperature and a calculated outdoor air wet-bulb temperature.

### ***THIS SCREEN DISPLAYS THE LOW SUPPLY AIR TEMPERATURE LIMIT.***

If the unit supply air temperature falls below Supply Air Low Limit for a period of Alarm Delay, the unit will shut down and an alarm will be signaled. The purpose of the supply low limit is to protect the building and contents from cold supply air. It is NOT designed to protect the air-handling unit.

If the unit does not have chilled water (CW) or hot water (HW) coils, it should not need additional protection from freezing. If the unit does have CW or HW coils, field provided coil freeze protection may be necessary.

### Defrost

Allow wheel defrost mode when outside is below: 05.0°F

### UnOcc Fan Cycle Setup

UnOcc Room Set Points:  
Heating: 65.0°F  
Cooling: 80.0°F  
Room RH: 50.0%  
Temp Diff: 5.0°F  
Dehumid Diff: 5.0%

### Supply Fan Speed SetPt

Active StPt: 100%  
Supply Fan Ramp: 100%  
Source: Local 100%  
UnOccupied Cycle 100%  
(0%=Min Speed by VFD)

### Supply Fan Speed SetPt

Active StPt: 50%  
Supply Fan Ramp: 50%  
Source: Local 50%  
Hi Spd/Max Vent: 100%  
UnOccupied Cycle: 100%

**THIS SCREEN DISPLAYS THE TEMPERATURE AT WHICH THE UNIT WILL ENABLE FROST CONTROL MODE IF NECESSARY. (FACTORY DEFAULT = 5°F)**

*This screen only appears if the unit has an energy recovery wheel and a frost control method was provided with the unit.*

Upon sensing a high differential pressure across the energy wheel, the unit will go into defrost if the outside air temperature is below this temperature setting.

**THIS SCREEN DISPLAYS THE ROOM SET POINTS DURING THE UNOCCUPIED MODE.**

*This screen only appears if an unoccupied recirculation damper was provided with the unit. Room sensor(s) must be wired to the controller.*

In the unoccupied mode, the unit will monitor the room temperature and humidity sensors. The unit will cycle on to maintain the unoccupied room set points by tempering recirculated air. The differential prevents short cycling. For example, in heating, the unit cycles on at 60°F and turns off at 65°F.

**THIS SCREEN DISPLAYS THE SUPPLY FAN SPEED SET POINTS.**

*This screen only appears if equipped with a supply fan VFD controlled by microprocessor.*

The speed set point is the proportional percentage of the analog output from the controller to the VFD.

0% Speed = Min speed (determined by VFD)

100% Speed = Max speed (determined by VFD)

UnOccupied Cycle - The supply fan speed when the unit is on during unoccupied cycle times.

#### **Possible Set Point Sources:**

**Local** – The fan speed will be constant set from screen (exp. 100%).

**BMS** – The BMS can directly control the fan speed (requires BMS communication option).

**Duct Pressure** – Fan speed is determined by duct pressure control loop.

**Building Pressure** - Fan speed is determined by building pressure control loop.

**CO2** - Fan speed is determined by CO2 control loop.

**2-Speed (High Speed Set Point)** - Supply fan speed is reset to “2 Spd Fan Hi Setpt:” when a contact closure is made. The 2-speed fan operation can also be setup to bring the unit into temporary occupied mode until the contact is broken (Max Ventilation Mode).

ExhaustFan Speed SetPt	
Active StPt:	100%
Exhaust Fan Ramp:	100%
Source: Local	100%
(0%=Min Speed by VFD)	

ExhaustFan Speed SetPt	
Active StPt:	0%
Exhaust Fan Ramp:	0%
Source: Sup Fan Track	
SF Speed	EF Speed
0% ---->	0%
100% ---->	100%

ExhaustFan Speed SetPt	
Active StPt:	0%
Exhaust Fan Ramp:	0%
Source: OA Damper Trk	
OA Damper	EF Speed
Min OA ---->	0%
Max CO2 ---->	50%
Max Econ ---->	100%

ExhaustFan Speed SetPt	
Active StPt:	0%
Exhaust Fan Ramp:	0%
Source: OA Damper Trk	
OA Damper	EF Speed
30% ---->	0%
Max BMS ---->	50%
Max Econ ---->	100%

**THIS SCREEN DISPLAYS THE EXHAUST FAN SPEED SET POINTS.**

This screen only appears if equipped with an exhaust fan VFD controlled by microprocessor.

The speed set point is the proportional percentage of the analog output from the controller to the VFD.

- 0% Speed = Min speed (determined by VFD)
- 100% Speed = Max speed (determined by VFD)

**Possible Set Point Sources:**

**Local** – The fan speed will be constant set from screen (exp. 100%).  
**BMS** – The BMS can directly control the fan speed (requires BMS communication option).

**Building Pressure** - Fan speed is determined by building pressure control loop.

**Supply Fan Tracking** – Exhaust speed proportionally tracks supply speed.

**Outdoor Air Damper Tracking** – The exhaust fan will proportionally track the outdoor air damper, between a minimum and maximum position.

**Normal Operation:** During non-economizer operation, the exhaust fan will track the outdoor air damper between the minimum outdoor air position (Min OA) and the maximum sequence position (Max CO2 or Max BMS). \*Note that if the OA Damper Set Point is controlled by the BMS, the exhaust fan tracking algorithm references an adjustable minimum position on the display. In this case, the outdoor air damper must open above this position before the exhaust fan begins increasing speed.

**Economizer Operation:** During economizer operation, the exhaust fan will track the outdoor air damper between the minimum outdoor air position and the maximum economizer position (Max Econ).

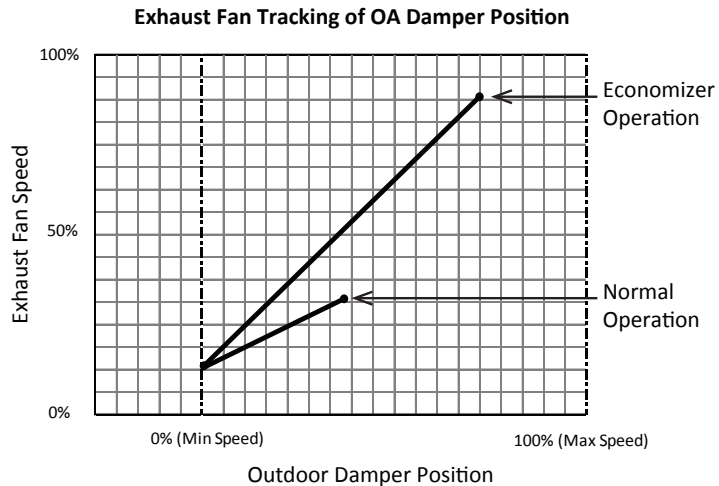

### Duct Pressure SetPt

Active StPt:	0.25" wc
Duct Pressure:	0.26" wc
Source: Local	0.25" wc
Min:	0.25" wc
Max:	2.00" wc

### ***THIS SCREEN DISPLAYS THE DUCT PRESSURE SET POINT.***

*This screen only appears if equipped with a duct pressure sensor.*

The unit will modulate the supply fan to maintain the local duct pressure set point. Set point source must be changed to BMS to allow BMS control.

### Single Zone VAV Setup

Supply Fan Speeds		
	Cooling	Heating
Min:	0%	0%
Max:	100%	100%
Cooling Fan Delay:	180s	

### ***THIS SCREEN DISPLAYS THE SINGLE ZONE FANS SPEED PARAMETERS.***

*This screen only appears if the supply fan VFD control is configured as Single Zone VAV. A room temperature sensor is required.*

When the unit is configured for single zone VAV, the heating, cooling and economizer are controlled to maintain the active supply air temperature set point, which is reset based on room temperature reset. The supply fan is modulated in addition to the supply air temperature to satisfy the room temperature set point. The minimum and maximum supply fan speed limits can be set during space cooling and heating.

**Space Cooling:** When the room requires cooling (the room is warmer than room temperature set point), the supply air temperature set point will reset as low as the minimum supply temperature set point (see supply temp set point screen) to try to cool the space. If further cooling is required, after the cooling fan delay, the supply fan will increase in speed to deliver more cooling to the space.

**Space Heating:** When the room requires heating (the room is cooler than the room temperature set point), the supply air temperature set point will reset as high as the maximum supply temperature set point (see supply temp set point screen) and the supply fan will increase in speed to deliver more heating to the space.

### CO2 Set Point

Active StPt:	1000PPM
CO2 Level:	1000PPM
Source: Local	1000PPM

### ***THIS SCREEN DISPLAYS THE CO2 SET POINT.***

*This screen only appears if equipped with a CO2 sensor.*

Depending on unit configuration, the unit will either modulate the supply fan or outdoor air damper to maintain the CO2 set point.

Set point source must be changed to BMS to allow BMS control.

### Building Press SetPt

Active StPt:	+0.010" wc
Building Ps:	+0.009" wc
Source: Local	+0.010" wc

### ***THIS SCREEN DISPLAYS THE BUILDING PRESSURE SET POINT.***

*This screen only appears if equipped with a building pressure sensor.*

Depending on unit configuration, the unit will either modulate the exhaust or supply fan to maintain the local building pressure set point.

Set point source must be changed to BMS to allow BMS control.

OA Damper Set Point	
Active StPt:	100%
Damper Position:	100%
Source: SF RESET	
SupplyFan: 0%	100%
Min OA: 30%	20%
2 PosMax/Max Econ:	100%

OA Damper Set Point	
Active StPt:	50%
Damper Position:	50%
Source: SF RESET	
SupplyFan: 0% --->	100%
Min OA: 50% --->	40%
2 PosMax/Max Econ:	100%

OA Damper Set Point	
Active StPt:	30%
Damper Position:	30%
Source: DCV CO2 -->	
SupplyFan: 0% -->	100%
Min OA: 30% -->	20%
Max CO2: 50%	40%
2 PosMax/Max Econ:	100%

OA Damper Set Point	
Active StPt:	25%
Damper Position:	25%
Source: BMS	25%
Max BMS:	50%
2 PosMax/Max Econ:	100%

BMS Optional Points		
OA Temp:	76.0	BMS
Room Temp:	71.0	Sensor
Outdoor RH:	25.0%	Sensor
Room RH:	20.0%	Sensor

**THIS SCREEN DISPLAYS THE OUTDOOR AIR DAMPER SET POINT.**

*This screen only appears if equipped with a modulating outdoor air and recirculating damper.*

The set point is the proportional percentage of the outdoor air damper being open.

- 0% = Full recirculation air
- 100% = Full outdoor air

**Minimum Position** – When in the occupied mode, the Active set point will be equal to a local minimum OA set point, which may be constant or reset by fan speed if equipped with a modulating supply fan. The OA damper set point can then be further adjusted between the minimum OA and maximum OA settings with sequences such as DCV CO2, Building Pressure and Economizer.

**Maximum Position** – Each sequence that can adjust the OA damper set point contains a maximum position to prevent excess OA. The Active set point will be determined based on the greatest demand of the configured sequences. For example, if a unit is equipped with a DCV CO2 and an economizer sequence, the OA damper set point will react to an economizer demand even if the CO2 set point is satisfied. Likewise, if economizer is not available but CO2 is above set point, the OA damper will open to satisfy the CO2 set point.

**Supply Fan Reset of OA Damper Position**

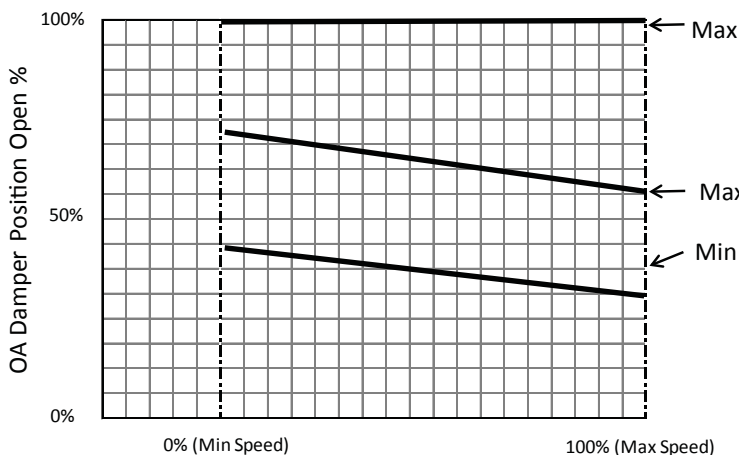

**Economizer** – The Active set point will be reset based on Economizer demand, between the minimum and maximum positions.

**Possible Set Point Sources:**

**Local** – The minimum outdoor air percentage is constant, set by the controller.

**SF Reset** – The min and max positions are reset by the supply fan speed.

**BMS** – The BMS can directly control the OA damper position up to the Max BMS position.

**Building Pressure** – Damper position is reset by a building pressure control loop.

**DCV CO2** – Damper position is reset by a demand-controlled ventilation control loop based on room CO2 levels.

**2 Position** – Damper position is reset to “2-Pos/Max Econ:” set point when a contact closure is made. The 2-position damper operation can also be setup to bring the unit into temporary occupied mode until the contact is broken (Max Ventilation Mode - enabled in manufacturer menu settings).

**THIS SCREEN ALLOWS THE USER TO CHANGE THE VALUE FROM SENSOR TO BMS**

*This screen only appears if BMS communication is set.*

If the BMS already knows one or more of these values from a weather station or some other device, the user has the ability to write the values to the controller. The controller will then control from these values.

## C. Clock/Scheduler

The **Clock/Scheduler** menu allows the user to view and alter the time and date. The user can also add up to seven schedules for occupancy requirements.

Set Date & Time	
Day:	Monday
Date:	MM/DD/YY
Hour:	15:30

Scheduler	
Number of schedules:	0
Holidays	
Holiday = unoccupied mode for 24 hours.	
Number of Holidays:	0

Scheduler	
Schedule #:	#
Time On:	07:00
Time Off:	15:00
Days Enabled:	MTWTFSS

Clock	
Daylight Savings Time	
DST:	ENABLE
Transition time:	60min
Start:	SECOND SUNDAY
in MARCH	at 2.00
End:	FIRST SUNDAY
in NOVEMBER	at 2.00

Holiday #1	
Month:	MM
Day:	DD
Unoccupied for 24 hrs	

Morning Warm-up	
Morning Warmup Off	
Temperature Diff:	2.0°F

### ***THE CLOCK SCREEN ALLOWS THE USER TO ADJUST THE TIME AND DATE.***

### ***THIS SCREEN ALLOWS THE USER TO ADD THE NUMBER OF UNOCCUPIED SCHEDULES AND HOLIDAYS.***

The Number of Schedules corresponds to the number of unoccupied periods the user wishes to add. By setting the number of schedules to a value greater than zero, the unoccupied mode will automatically be set to time clock.

A holiday is a single occurrence in which you would like the unit to be unoccupied for 24 hours. A maximum of 15 holidays can be set. Holidays must be reconfigured each year.

### ***THIS SCREEN ALLOWS THE USER TO ADJUST SCHEDULES.***

*This screen only appears if a Schedule was added in the screen above.*

The program supports up to seven separate schedules. Each schedule will require the user to enter a time on, time off and which days the schedule is applicable for.

### ***THIS SCREEN ALLOWS THE USER TO MODIFY THE DAYLIGHT SAVINGS TIME FUNCTION.***

The internal clock is set by default to adjust for daylight savings time. On this screen the user can enable, disable, or change when the unit compensates for daylight savings time.

### ***THIS SCREEN ALLOWS THE USER TO SET HOLIDAY DATES (IF ENABLED).***

*This screen only appears if Holidays are enabled.*

The internal time clock will go into unoccupied mode as long as the date is equal to the holiday date (always a 24 hour period).

### ***THIS SCREEN ALLOWS THE USER TO ENABLE THE MORNING WARM-UP SEQUENCE AND THE DIFFERENTIAL REQUIRED TO ALLOW THE SEQUENCE TO OCCUR.***

*This screen only appears if unoccupied tempering is available and scheduler is set.*

The morning warm-up sequence calculates the time required to temper the space to the occupied set point prior to occupancy. This sequence is limited between 10 to 60 minutes. The controller will re-evaluate the heating and cooling rate daily to continually adjust to the changing climate.

## D. Input/Output

The **Input/Output** menu allows the user to quickly view the status of the controller inputs and outputs.

Analog Input	
Outside Temperature Input U001:	75.0°F

To manually control I/O values, go to the **Service menu > Overrides**.

Similar screens appear for all controller inputs and outputs.

***Your controller may not utilize all equipped of the inputs and outputs shown. See unit wiring diagram for your specific configuration.***



## E. Data Logger

The **Data Logger** menu allows the user to view up to 100 past alarms.

13:21:04	MM/DD/YY
OA TEMP SENSOR	
Outside Air T:	-623.3
Discharge T:	52.8
Cold Coil T:	55.9
Room T:	72.5
SYS ON-HEATING	

**THIS SCREEN IS AN EXAMPLE OF A RECORDED ALARM.**

The unit conditions are displayed for past alarm events. The date, time, temperatures and unit status are recorded.

To clear recorded alarms, press  and  simultaneously.

## F. Board Switch

The **Board Switch** menu allows the user to jump between different controllers with a remote display. This requires a remote display, along with additional controllers, setup in a pLAN network. A pLAN can consist of up to 32 devices, in different combinations, but a maximum of 31 controllers.

Board Switch	
Unit Address:	1
Switch to unit:	1
1 . . . . .	16
17 . . . . .	32

**WHEN VIEWING THIS SCREEN FROM A REMOTE DISPLAY, THE USER IS ABLE TO CHANGE WHICH CONTROLLER'S MENU SHOULD BE DISPLAYED.**

Unit Address: The pLAN address of the controller the display is currently accessing.

Switch to unit: The pLAN address of the controller the display would like to access.

## G. Service

The **Service** menu allows the user to access several sub-menus regarding controller information, controller overrides, operating hours, BMS configuration, I/O manual management and Probe Adjustment. The user can also change the default Service Password (1000) by accessing the **Service Settings** sub-menu. By accessing the **BMS Config** sub-menu, the user can adjust BMS protocol settings. (BACnet®, LonWorks®, Modbus®)

### G. Service

#### a. Information

Information	
Greenheck Fan	
Code: GWKDX000XXXX	
Furnace Code: GUSXSX	
Ver.2.50	5/1/17
Manual:	482574
Bios: 6.27	11/17/10
Boot: 4.03	07/03/06

**ENTERING THE INFORMATION SUB-MENU WILL DISPLAY INFORMATION ABOUT THE CONTROLLER AND THE PROGRAM LOADED ON THE CONTROLLER.**

**Code:** Controller setup code determines functionality of program. When contacting the factory, please reference this code.

**Ver:** Displays the current program version and data code of the current program.

**Manual:** The manufacturer part number for the corresponding Installation, Operation and Maintenance (IOM) Manual.

### G. Service

#### b. Overrides

- a. Analog Inputs
- b. Digital Inputs
- c. Relay Outputs
- d. Analog Outputs
- e. Control Loops

The **Overrides** menu is for start-up, commissioning and troubleshooting. This menu allows the user to override the control loops and specific inputs and outputs. To access the Overrides sub-menus, enter the service password (**Default=1000**).

**Caution: overriding components and I/O can be dangerous to the equipment. Always cycle power to the unit when finished with the override.**

#### Analog Input

Outside Temperature	
Manual Control B005:	OFF
Manual Position 0.0	
Value	73.5

**THIS SCREEN IS AN EXAMPLE OF A MANUALLY MANAGED TEMPERATURE ANALOG INPUT.**

To manually control an analog input, change manual control to on. Move cursor to manual position and alter value. The altered value will be displayed below.

Similar screens exist for the remaining I/O. To resume normal operation, simply cycle power to the unit. Contact the factory for more details.

#### Control Loop Overrides

Unit must be ON.  
To resume normal operation, cycle unit power.

To manually override a control loop, the unit must be on. In each respective screen, change the control from auto to manual.

To resume normal operation after overriding the controller, simply cycle power to the unit.

Energy Wheel Override	
Wheel Control:	Auto
Wheel:	OFF

Energy Wheel Override	
Wheel Control:	Auto
Wheel:	100%

Wheel Preheat Override	
Energy Recovery Wheel	
Preheat Control:	Auto
Preheater:	OFF

Cooling Override	
Cooling Control:	Auto
Cooling:	100%

Heating Override	
Heating Control:	Auto
Heating:	100%

---

**THIS SCREEN ALLOWS THE USER TO OVERRIDE THE ENERGY WHEEL OPERATION.**

---

*This screen only appears if the unit is equipped with a non-VFD operated energy wheel.*

When the wheel control is in the manual mode, use the arrow buttons to turn the wheel on or off.

---

**THIS SCREEN ALLOWS THE USER TO OVERRIDE THE ENERGY WHEEL OPERATION.**

---

*This screen only appears if the unit is equipped with a VFD operated energy wheel.*

When the wheel control is in the manual mode, use the arrow buttons to alter the wheel %. This is directly proportional to a 0 - 10 VDC signal being sent to the energy wheel VFD.

---

**THIS SCREEN ALLOWS THE USER TO OVERRIDE THE ENERGY RECOVERY WHEEL PREHEATER.**

---

*This screen only appears if an electric preheat frost control was provided with the unit.*

---

**THIS SCREEN ALLOWS THE USER TO OVERRIDE THE COOLING OPERATION.**

---

*This screen only appears if a cooling operation was provided with the unit.*

When the cooling control is in the manual mode, use the arrow buttons to vary the cooling output.

**Chilled Water:** The Cooling % is directly proportional to the 0 - 10 VDC output signal.

0% Cooling = 0 VDC; 100% Cooling = 10 VDC

**Packaged Cooling and Heat Pump:** The cooling percent displays compressor engagement as a percent. The compressors are subject to the minimum on/off times and heating/Cooling lockouts. Compressors engage in sequence as described in the compressor staging screen in the

**Manufacturer > Factory Settings** menu.

---

**THIS SCREEN ALLOWS THE USER TO OVERRIDE THE HEATING OPERATION.**

---

*This screen only appears if a heating operation was provided with the unit.*

When the heating control is in the manual mode, use the arrow buttons to vary the heating output.

**Electric Heater:** The heater control percent is proportional to the 0-10 VDC signal being sent to the SCR controller, located in the electric heater control center.

0% Heating = 0 VDC - 0 kW output

100% Heating = 10 VDC - Max kW output

**Hot Water:** The heater control percent is proportional to the 0-10 VDC signal being sent to the heating control valve (by others).

0% Heating = 0 VDC

100% Heating = 10 VDC

**Indirect Gas:** The heater control percent is proportional to the 0-10 VDC signal being sent to the indirect gas furnace controller, located in the indirect gas control center. The first stage is on at 1% heater control. The furnace will then modulate proportionally from minimum to maximum capacity. The furnace is subject to minimum on/off times and Heating Lockouts.

0% = 0 VDC - Off

1% = 0 VDC - Minimum turndown enabled

1 - 100% = 0 - 10 VDC = Furnace modulation

**Heat Pump:** The heating percent displays compressor engagement as a percent. The compressors are subject to the minimum On/Off times and Heating Lockouts. Compressors engage in sequence as described in the Compressor Staging screen in the **Manufacturer > Factory Settings** menu.

HotGas Reheat Override	
Hot Gas Reheat	
Loop Control:	Auto
Reheat:	OFF

HotGas Reheat Override	
Hot Gas Reheat	
Loop Control:	Auto
Reheat:	100%

Supply VFD Override	
Supply Fan VFD	
Loop Control:	Auto
Speed:	0%
(0%=Min Speed by VFD)	

Exhaust VFD Override	
Exhaust Fan VFD	
Loop Control:	Auto
Speed:	0%
(0%=Min Speed by VFD)	

OA/RA Damper Override	
Outdoor Damper	
Loop Control:	Auto
Open:	0%

**G. Service**  
c. BMS Config

BMS Configuration	
Protocol:	BACnet MSTP
BACnet Plugin?	YES

MODBUS SETUP	
Address:	1
Baudrate	19200
Stop bit:	2
Parity mode:	NONE

**THIS SCREEN ALLOWS THE USER TO OVERRIDE THE HOT GAS REHEAT OPERATION.**

*This screen only appears if on/off hot gas reheat option was provided with the unit.*

When the hot gas reheat loop control is in the manual mode, use the arrow buttons to turn the hot gas reheat on or off.

**THIS SCREEN ALLOWS THE USER TO OVERRIDE THE HOT GAS REHEAT OPERATION.**

*This screen only appears if modulating hot gas reheat option was provided with the unit.*

When the hot gas reheat loop control is in the manual mode, use the arrow buttons to vary the reheat output.

**THIS SCREEN ALLOWS THE USER TO OVERRIDE THE SUPPLY FAN VFD SPEED.**

*This screen only appears if the unit is equipped with a supply fan VFD controlled by the microprocessor.*

The speed is the proportional percentage of the analog output from the controller to the VFD.

0% Speed = Min speed (determined by VFD)

100% Speed = Max speed (determined by VFD)

(See unit Installation and Operation Manual for VFD programming).

**THIS SCREEN ALLOWS THE USER TO OVERRIDE THE EXHAUST FAN VFD SPEED.**

*This screen only appears if the unit is equipped with a exhaust fan VFD controlled by the microprocessor.*

The speed is the proportional percentage of the analog output from the controller to the VFD.

0% Speed = Min speed (determined by VFD)

100% Speed = Max speed (determined by VFD)

(See unit Installation and Operation Manual for VFD programming).

**THIS SCREEN ALLOWS THE USER TO OVERRIDE THE POSITION OF THE OUTDOOR AIR DAMPER.**

*This screen only appears if the unit is equipped with a modulating outdoor air damper.*

0% Open = Outdoor air damper closed

100% Open = Outdoor air damper fully open

The **BMS Config** menu allows the user to view and alter BMS protocol settings. If the BMS protocol is BACnet or Modbus, additional screens allow further configuration. See below for details. To access the BMS Config sub-menu, enter the service password (**Default=1000**). See *Appendix A: BACnet® MSTP or BACnet® IPI/Eth Quick Start* for more information.

**THIS SCREEN ALLOWS THE USER TO SELECT THE BMS PROTOCOL. ALL BMS PROTOCOLS REQUIRE A COMMUNICATIONS CARD INSTALLED IN THE SERIAL CARD PORT, LOCATED ON THE FACE OF THE CONTROLLER.**

If the protocol is BACnet MSTP or BACnet IP/Eth, the user can change common BACnet parameters via the controller. The BACnet Plugin must be set to YES.

**THIS SCREEN ALLOWS THE USER TO ADJUST MODBUS PARAMETERS.**

*This screen only appears if the selected BMS protocol is set to Modbus.*

The address is the Modbus address of the card installed in the serial card port located on the face of the controller. (**Factory Default Address = 1**).

## MSTP SETUP

Instance:	77000
Baudrate	38400
MAC Addr:	0
MaxMasters:	127
MaxInfoFrames:	20

## BACnet Read/Write

To save:	Change
Function:	to write and update to Yes. Then cycle unit power to confirm write command.
Function:	Read
Update?	Yes

## TCP/IP SETUP

Instance:	77000
IP set by:	DHCP
IP:	128.2.104.134
Subnet:	255.255.000.000
Gateway:	128.2.0.12

## TCP/IP SETUP

DNS 1:	193.168.001.001
DNS 2:	193.168.001.001
Type:	IP

## BACnet Read/Write

To save:	Change
Function:	to write and update to Yes. Then cycle unit power to confirm write command.
Function:	Read
Update?	Yes

### ***THIS SCREEN ALLOWS THE USER TO ADJUST BACNET MSTP PARAMETERS.***

*This screen only appears if the selected BMS protocol is set to BACnet MSTP and BACnet Plugin = YES.*







If a BACnet MSTP card has been installed, the default parameters can be changed via the controller display. Factory settings are shown in the screen to the left.

To view current parameters:

1. Power on controller and allow several minutes to initialize.
2. Go to **BMS Config** menu and view BACnet Read/Write screen.
3. Change *Function* to *Read* and *Update?* to *YES*.

Current BACnet MSTP parameters should now be displayed in the BACnet MSTP SETUP screen. If all values appear to be zeros, consult the factory. (Make sure you have allowed several minutes for the controller to initialize). *\*Values may appear to be zero prior to setting the Function to READ.*

To change BACnet MSTP parameters:

1. Power on controller and allow several minutes to initialize.
2. Go to **BMS Config** menu and view MSTP SETUP screen.
3. Move cursor to desired parameter by pressing the   buttons. Press  to select the parameter to change. Press the   buttons to adjust the parameter. Press  to save adjusted value.
4. Once desired parameters have been entered, go to BACnet Read/Write screen. Change *Function* to *Write* and *Update?* to *YES*.
5. Reboot the controller by cycling power to the unit. Allow several minutes for the controller to initialize.
6. View MSTP parameters. If changed values did not save, contact the factory.

### ***THIS SCREEN ALLOWS THE USER TO ADJUST BACNET IP PARAMETERS.***

*This screen only appears if the selected BMS protocol is set to BACnet IP/Eth and BACnet Plugin = YES.*

If a BACnet IP card has been installed, the default parameters can be changed via the controller display. **The card is in DHCP mode from the factory.** Once communication is established, the user can enter static IP parameters.







To view current parameters:

1. Power on controller and allow several minutes to initialize.
2. Go to **BMS Config** menu and view BACnet Read/Write screen.
3. Change *Function* to *Read* and *Update?* to *YES*.

Current BACnet IP parameters should now be displayed in the BACnet TCP/IP setup screen. If all values appear to be zeros, consult the factory. (Make sure you have allowed several minutes for the controller to initialize).

*\*Values may appear to be zero prior to setting the Function to READ.*

To change BACnet TCP/IP parameters:

1. Power on the controller and allow several minutes to initialize.
2. Go to **BMS Config** menu and view TCP/IP SETUP screen.
3. Move cursor to desired parameter by pressing the   buttons. Press  to select the parameter to change. Press the   buttons to adjust the parameter. Press  to save adjusted value.
4. Once desired parameters have been entered, go to BACnet Read/Write screen. Change *Function* to *Write* and *Update?* to *YES*.
5. Reboot the controller by cycling power to the unit. Allow several minutes for the controller to initialize.
6. View TCP/IP parameters. If changed values did not save, contact the factory.

## G. Service

- d. Service Settings
  - a. Working hour set
  - b. Probe adjustment
  - c. Password/Defaults

### MAINTENANCE HOURS

SYSTEM	
Run hours:	0000h
Set Point:	0000h
Reset to Zero?	No

### Analog Input

Outside Temperature	
Offset:	0.0°F
Value:	70.5°F

### User Default



Insert new service password (PW1): 1000

### User Default Settings



Save?	No
Restore?	No

### Program Menu Lock



Lock program menus using service password? (PW1): No

## G. Service

- e. Commissioning
  - a. Furnace Commissioning

### Furnace Commissioning

Enter Furnace Commissioning: No

The **Service Settings** menu allows the user to change the default Service Password (1000), save and restore default parameters, and adjust probe values.

---

**THIS SCREEN ALLOWS THE USER TO VIEW UNIT RUN HOURS, AND ALTER SET POINTS FOR MAINTENANCE.**

---

**Run hours:** The amount of time in hours that the unit has been powered.

**Set Point:** The amount of running time in hours before a maintenance alarm should occur.

**Reset to Zero:** Reset the measured amount of run time.

---

**THE PROBE ADJUSTMENT MENU ALLOWS THE USER TO CALIBRATE SENSOR PROBES WITH AN OFFSET VALUE.**

---

Similar screens are available for remaining sensor probes.

---

**THIS SCREEN ALLOWS THE USER TO CHANGE THE SERVICE LEVEL PASSWORD (PW1)**

---

---

**THIS SCREEN ALLOWS THE USER TO SAVE AND RESTORE THE DEFAULT PARAMETERS STORED IN MEMORY.**

---

If the user would like to save their settings, move the cursor to the save position and change to yes. This will save all of the current parameters into memory as Service Settings. If the user would like to restore to these values at some point in the future, moving the cursor to the restore position, and selecting yes will restore the controller to the user saved defaults.

---

**THIS SCREEN ALLOWS THE USER TO LOCK THE PROGRAM MENU.**

---

Locking the program menu will prohibit users from changing any parameters. Only menus normally accessed by pressing  will be locked. Users will still be able to view unit status, alarms and temperatures.

The **Commissioning** menu allows the user to go through a pre-programmed step-by-step process to set up different unit functions in the field. To successfully commission the unit, additional tools will be required to make adjustments. To access the Commissioning sub-menu, enter the service password (**Default=1000**).

---

**THIS SCREEN ALLOWS THE USER TO ENTER IG FURNACE COMMISSIONING**

---

*This screen only appears if Indirect gas furnace was provided with the unit.*

Entering the furnace commissioning menu will step the user through the furnace start-up.

## H. Manufacturer

### a. Configuration

**Configuration** menu allows the user to change the setup code for the unit, enable Scheduling, Holidays, expansion I/O and change Field Card settings. Users are welcomed to enable Scheduling and Holidays. **However, code changes and expansion I/O enabling are to be done under factory advice only!**

#### Unit Code

Select DDC configuration code here.  
 Code: GUK2X000XMMX  
 Code: GUSXDX  
 Save Config: No

#### **THIS SCREEN DISPLAYS AND ALLOWS ADJUSTMENT OF THE UNIT CODE.**

This code is set from the factory to operate the components selected with the unit. When troubleshooting, refer to the wiring diagram sent with the unit (located on the control center door) to verify the unit code is correct. The code will be listed on the wiring diagram. If changes to the setup code are required, save the configuration by changing save config to yes.

#### Unit Expansion I/O

Enable Expansion: No

#### **THIS SCREEN ALLOWS THE USER TO ENABLE ADDITIONAL I/O POINTS.**

*Unit I/O expansion requires the installation of a pCOe and field card. See page 34 for more information.*

Enabling the I/O expansion allows the user to add the following points for monitoring:

- Four analog inputs (0/1vdc, 0/5vdc, 0/20mA, 4/20mA, NTC Temp)
- One analog output (0/10vdc)
- Four digital inputs
- Four digital outputs

The additional I/O points available on the pCOe expansion module allow the user to monitor and control the additional points over the BMS and user display. See *Appendix D: Expansion I/O (pCOe) Quick Start* for more information.

#### Controller pLAN Setup

Current pLAN Addr: 1  
 New pLAN Addr: 1  
 pLAN Port  
 Protocol: pLAN

#### **THIS SCREEN ALLOWS THE USER TO VIEW AND CHANGE THE CONTROLLER pLAN ADDRESS.**

A pLAN (pCO Local Area Network) is a Carel® proprietary local area network, allowing the user to connect multiple controllers to one remote display panel. Each controller on a pLAN must have a unique address.

This address is only applicable for units connected on a pLAN. For BACnet, LonWorks or Modbus parameters, go to **Service > BMS Config**.

#### T-Stat Config

Modbus Address: 10  
 Online: No  
 T-Stat Temp: 0.0°F  
 Number of T-Stats: 1

#### **THIS SCREEN ALLOWS THE USER TO ENABLE AND SET UP MODBUS CONNECTED ROOM THERMOSTATS.**

The thermostats must be factory supplied with ModBus in order to use this function. See *Appendix B: Room Thermostat Quick Start* for more information.

#### Airflow Setup

Enable: Outdoor Airflow  
 Enable: Exhaust Airflow  
 Enable: None

#### **THIS SCREEN ALLOWS THE USER TO ENABLE UP TO 3 DIFFERENT AIRFLOW MONITORING STATIONS ON THE UNIT.**

The airflow monitors must be factory supplied with ModBus capability and the unit must be configured with ModBus or BACnet® communication to allow remote viewing of the airflows. See *Appendix C: GreenTrol Quick Start* for more information.

## H. Manufacturer

### b. I/O Configuration

The **I/O Configuration** menu allows adjustment of all controller inputs and outputs. This menu is similar to the **Probe Adjustment** menu, except that it additionally allows adjustment of the factory default 'normal' states of the digital inputs and the direction of the analog outputs. Additionally, it allows adjustment of the physical location of each I/O. **ADJUSTMENT OF I/O PHYSICAL LOCATION MUST ONLY BE DONE UNDER FACTORY GUIDANCE! IMPROPER ADJUSTMENT MAY RESULT IN SYSTEM DAMAGE!**

Analog Input	
Outside Temperature	
En: ON	Ch: U005
Normal	NTC
Offset:	0.0°F
Value:	70.5°F

This is an example of an analog input configuration screen.

In the I/O configuration screens, the user can alter the physical location and type of each point.

Similar configuration screens appear for the remaining I/O.

Alarm Time Delay	
Outside Temperature	
Input B0005:	73.5°F
Out of Range Alarm	
Power Delay:	30s
Run Delay:	30s
Units:	Temperature

Digital Input	
Remote On/Off	
Enable: ON Channel:	4
Action:	CLOSED
Delay:	0s
Status:	Closed

Relay Output	
Defrost	
Enable:	Yes
Channel:	1
Status:	OFF

Analog Output Config	
Cool:	
Enable:	Yes
Channel:	3
Action:	DIRECT
Minimum:	0.0vdc
Maximum:	10.0vdc

## H. Manufacturer

### c. Factory Settings

The **Factory Settings** menu allows adjustment of parameters that are critical for proper unit operation. Adjustment of these parameters is only recommended with factory guidance. To access the Factory Settings menu, enter the manufacturer password (**Default=1000**).

Economizer Controller	
Allow mechanical cooling during econ?	Yes
Wheel/Bypass Damper:	
Offset from minOA:	5%
Hysteresis:	3%

**THIS SCREEN ALLOWS THE ADJUSTMENT OF THE ECONOMIZER FUNCTION.**

*This screen only appears if an economizer mode was selected with the unit.*

If the unit was selected with cooling and economizer, the user has the option to allow mechanical cooling during the economizer mode.

If the unit is equipped with an energy wheel and bypass dampers, the bypass dampers will open and the energy wheel will turn off once the modulating outdoor air dampers have opened more than the offset.

Disable Exhaust Fan	
Exhaust fan available only during econ mode?	
	No

**THIS SCREEN ALLOWS THE USER TO DISABLE THE EXHAUST FAN EXCEPT IN ECONOMIZER MODE**

*This screen only appears if economizer mode is selected, the unit has recirculation, and the exhaust fan is tracking the outdoor air dampers.*

This functionality allows the exhaust fan to track the outdoor air damper only during economizer mode.

Defrost Cycle Setup	
Defrost minimum cycle times.	
Defrost mode:	5min
Normal mode:	30min

**THIS SCREEN ALLOWS THE ADJUSTMENT OF THE DEFROST CYCLE TIMERS.**

*This screen only appears if timed exhaust frost control or energy wheel cycle frost control was provided with the unit.*

The on/off times prevent the build up of frost on the energy wheel if frost conditions are present.

Cooling Controller	
Integration:	300s
Band:	20°F
Cooling Loop:	0.0%
Cold Coil Loop:	0.0%

Cold Coil Protection	
SA-ACC Temp>:	10.0°F
Lockout Delay:	120s
Lockout Time:	600s

Compressor Setup	
# of stages:	2
Rotation:	LIFO

Digital Compressor	
Minimum OFF:	1.0vdc
Minimum ON:	1.9vdc
Maximum:	5.0vdc
Delay OFF:	120s
Max Power Start:	60s

Compressor Timers	
Minimum ON:	30s
Minimum OFF:	180s
Between Stages:	30s

---

**THIS SCREEN ALLOWS ADJUSTMENT OF THE COOLING PI CONTROL LOOP.**

---

*This screen only appears if cooling option was provided with the unit.*

The controller utilizes a PI loop control for cooling. This allows for less sporadic changes in supply temperature, resulting in a smooth reaction to changing conditions. To speed up reaction time, decrease the integration time. For slower reaction time, increase the integration time. When making adjustments, make them in small increments and test the system to determine if the new setting is adequate prior to further adjustment. The band is the range that the integration will occur between.

---

**THIS SCREEN ALLOWS THE ADJUSTMENT OF THE COLD COIL FREEZE-UP PROTECTION PARAMETERS.**

---

*This screen only appears if DX cooling was provided with the unit.*

This sequence protects the evaporator coil from freezing up in cooling mode when the discharge air sensor is registering false readings.

**SA-ACC Temp > :** The supply air minus after cooling coil air if greater than set point will represent the cold coil low temperature limit.

**Lockout Delay:** If the supply air discharge temperature minus the after cooling coil temperature is greater than set point for the lockout delay time set point, the cooling loop will reference the cold coil temperature in lieu of the supply air discharge temperature to prevent freeze ups.

**Lockout Time:** This is the amount of time the supply air discharge temperature sensor will be locked out. During this time the unit will reference the after cooling coil temperature sensor.

After three lockouts, the unit will go into alarm and the supply air discharge temperature sensor will be locked out. During this time the unit will reference the after cooling coil temperature sensor until the alarm is cleared.

---

**THIS SCREEN DISPLAYS THE NUMBER OF STANDARD COMPRESSOR STAGES PROVIDED WITH THE UNIT AND SHOWS THE ROTATION SEQUENCE.**

---

*This screen only appears if DX cooling was provided with the unit.*

The number of stages displayed is equal to the number of non-modulating compressors. Factory default compressor rotation is LIFO (Last In, First Out). Compressor rotation can not be changed on units equipped with: digital scrolls, hot gas reheat or heat pump.

---

**THIS SCREEN DISPLAYS THE DIGITAL SCROLL COMPRESSOR PARAMETERS.**

---

*This screen only appears if a digital scroll compressor was provided with the unit.*

**Minimum Off:** This is the minimum voltage the controller outputs when the digital scroll is disabled/off

**Minimum On:** This is the minimum voltage the controller outputs when the digital scroll is enabled/on.

**Maximum:** This is the maximum voltage the controller outputs when the digital scroll is operating at full capacity.

**Delay Off:** Delays shutting off digital scroll by this duration.

**Max Power Start:** Upon starting, the digital scroll will run at full capacity for this duration. This ensures the refrigeration system is at proper conditions, prior to modulation.

---

**THIS SCREEN DISPLAYS THE COMPRESSOR MINIMUM ON AND OFF TIMES.**

---

*This screen only appears if DX cooling was provided with the unit.*

The compressor minimum on/off times prevents short cycling of the compressors.





### Compressor Staging

Stage1: ON @ 50% OFF 0%  
Stage2: ON @100% OFF50%

### Heater Controller

Band: 60°F  
Integration: 300s  
Derivative: 0s  
Off Delay: 60s  
Temp Protection: Off

### Heater Reheat

Will heater be used for reheat during dehumidification?  
Reheat: Disable

### Heater Reheat 2

Will heater be used for reheat along with hot gas?  
Heater: Disable

### HTD Furnace Config 1

Stage Up Setpts  
Stge up heat %: 100%  
Diff below setpt: 2°F  
Stage up delay: 30s  
Heat % reset lo: 20%

### HTD Furnace Config 2

Stage Up Setpts  
Stge dn heat %: 2%  
Diff above setpt: 0°F  
Stage dn delay: 30s  
Heat % reset lo: 95%

### IG Heater Setup

Modbus Address Fur1: 3  
Modbus Address Fur2: 7  
Alarm lockout: 60s  
Lockout Retrys: 5  
Modulation Type: HTD

**THIS SCREEN DISPLAYS WHEN EACH COMPRESSOR IN A SINGLE OR DUAL STAGE DX UNIT WILL ENGAGE/DISENGAGE.**

*This screen only appears if DX cooling was provided with the unit.*

Each compressor will engage and disengage based upon the percentage of cooling capacity the controller needs.

**THIS SCREEN ALLOWS ADJUSTMENT OF THE HEATING PI CONTROL LOOP.**

*This screen only appears if heating option was provided with the unit.*

The controller utilizes a PI loop control for heating. This allows for less sporadic changes in supply temperature, resulting in a smooth reaction to changing conditions. To speed up reaction time, decrease the integration time. For slower reaction time, increase the integration time. When making adjustments, make them in small increments and test the system to determine if the new setting is adequate prior to further adjustment. The band is the range that the integration will occur between. The off delay allows the heating output to temporarily overshoot the set point without dropping the call for heat to prevent unwanted cycling.

When the system requirements are met, the temp protection functionality enables the supply fan on 100% OA units or OA/RA damper on partial recirc units to modulate down to help the unit keep up with the heating demand in event of wheel failure or outside design conditions. Once set point is achieved the unit goes back to normal operation.

**THIS SCREEN ALLOWS THE USER TO ENABLE THE HEATER FOR REHEAT PURPOSES.**

*This screen appears if a heating option was provided and the unit does NOT have hot gas reheat OR a heat pump.*

If it is desired that the heater be used to reheat the air off of the cooling coil when in dehumidification, adjust this screen so the heater is enabled for reheat. By enabling this feature, the heating lockout temperature in the set point menu also needs to be adjusted.

**THIS SCREEN ALLOWS THE USER TO ENABLE THE HEATER TO PROVIDE REHEAT IN ADDITION TO HOT GAS REHEAT**

*This screen appears if hot gas reheat and a heating option was provided (except heat pump).*

Setting the heater parameter to enable allows the heating option to provide additional reheat beyond what the hot gas reheat can provide. This would typically only be used if the supply air temperature is too cold. By enabling this feature, the heating lockout temperature in the set point menu also needs to be adjusted.

**THIS SCREEN ALLOWS ADJUSTMENT OF THE HTD DIRECT GAS FURNACE**

*This screen appears if a HTD indirect gas furnace was provided with the unit.*

Stage up/dn heat% is the percent at which the furnace must be firing at in order for the second manifold of the furnace to turn on. Diff above/below setpt is the amount the furnace must be away from setpt before the second manifold can turn on. Stage up/dn delay is the amount of time the furnace remains at the current state before a manifold is started / shut off. Heat % reset hi/lo is the modulation percent that the furnace is reset to after turning a manifold on or off.

**Caution: Adjusting these settings incorrectly can significantly impair heater performance and reduce heater life. Consult factory before adjusting.**

**THIS SCREEN ALLOWS ADJUSTMENT OF THE INDIRECT GAS FURNACE.**

*This screen appears if indirect gas furnace was provided with the unit.*

Allows changes to the Modbus address of Furnace 1 and Furnace 2 if supplied. Alarm lockout delay between retries of furnace alarms and the number of retries the furnace is allowed before its lockout.

### IG Heater Setup 2

High Speed StPt:	50.0
High Speed Diff:	5.0
Mod Output:	Linear
Enable Deadband:	Yes
Deadband:	3°F
High Max Temp:	125.0°F
High Diff Temp:	85.0°F

### IG Quick Compensation

Disable QC:	No
Temp Diff:	3.0F
Diff Time:	60s
Max QC time:	200s

### IG Forced Start 2

QC Heat Band:	30°F
QC Integration:	210s
QC Derivative:	20s
QC Deadband:	5°F
QC ReturnDiff:	2°F
QC ReturnTime:	20s

### Hot Gas Controller

Integration:	300s
Band:	20°F

### Hot Gas Reheat Timers

Hot gas reheat coil minimum on/off time:	10min
Flush cycle:	6hrs
Duration:	6min

### **THIS SCREEN ALLOWS ADJUSTMENT OF THE INDIRECT GAS FURNACE.**

*This screen appears if indirect gas furnace was provided with the unit.*

High speed set point is the heating percentage that sends the combustion fan to high speed. High speed differential is the heating percentage below the set point that the combustion fan goes to low speed. ModOut is linear or scaled based on the modulating gas value used. The dead band prevents the PID loop from shutting off the heat until the supply temp is outside the specified temp range. High max temperature is the temperature the supply discharge must exceed before the high discharge temperature alarm is generated. High differential temperature is the temperature the supply discharge must be reduced too for the high discharge temperature alarm to reset.

**Caution: Adjusting these settings incorrectly can significantly impair heater performance and reduce heater life. Consult factory before adjusting.**

### **THIS SCREEN ALLOWS ADJUSTMENT OF THE INDIRECT GAS FURNACE.**

*This screen appears if indirect gas furnace was provided with the unit.*

Quick compensation allows a separate control loop to quickly and accurately ramp the furnace up to the desired discharge temp without overshooting. Once the furnace tubes are warmed up and the discharge temperature has stabilized, the control switches back to the normal furnace control loop. Adjustable parameters include control loop temp differential, required time in temp differential and max run time of quick compensation loop.

### **THIS SCREEN ALLOWS ADJUSTMENT OF THE INDIRECT GAS FURNACE.**

*This screen appears if indirect gas furnace was provided with the unit and force start is enabled.*

The quick compensation uses a PID control loop. The heat band is the proportional characteristic of the loop. The greater the heat band, the less time that the furnace is at 100% heating in order to achieve the temperature set point. Decreasing the heat band may result in the furnace overshooting the discharge set point on initial start up. The integration and derivative adjust the proportional band with respect to time and temperature. To decrease the reaction time of the loop, increase the integration and/or derivative time. To increase the reaction time of the loop, decrease the integration and/or derivative time. The dead band prevents the PID loop from shutting off the heat until the supply temp is outside the specified temp range. QC Return Diff/time are parameters that allow the quick compensation loop to be re-enabled once the initial loop operation has ended.

### **THIS SCREEN ALLOWS ADJUSTMENT OF THE HOT GAS REHEAT PI CONTROL LOOP.**

*This screen only appears if hot gas reheat was provided with the unit.*

The controller utilizes a PI loop control for reheat. This allows for less sporadic changes in supply air temperature, resulting in a smooth reaction to changing conditions. To speed up reaction time, decrease the integration time. For slower reaction time, increase the integration time. When making adjustments, make them in small increments and test the system to determine if the new setting is adequate prior to further adjustment. The band is the range that the integration will occur between.

### **THIS SCREEN ALLOWS ADJUSTMENT OF THE HOT GAS REHEAT TIMERS.**

*This screen only appears if on/off hot gas reheat or hot gas reheat with flush was provided with the unit.*

If equipped with on/off control, the minimum on/off timers prevent short cycling of the coil, allowing for better oil distribution through the DX system. **CONSULT THE FACTORY BEFORE CHANGING THE MINIMUM ON/OFF TIMES.**

For modulating valves that require a refrigerant flush, the controller will provide a momentary flush of the hot gas reheat system. This prevents the build up of oil in the reheat coil. The flush sequence starts by fully opening the reheat valve for a period of Duration (**Factory Default = 6 minutes**). Once the flush duration is complete, the valve resumes modulation for a period of flush cycle (**Factory Default = 6 hours**).



### Mod Hot Gas Setup

Minimum ON: 4.0vdc  
Maximum ON: 10.0vdc

### Supply Reset Control

Integration: 1200s  
Band: 10°F

### Single Zone Set Points

In heat mode the fan will ramp when supply setpt is 5°F above room setpt.

#### Cool Mode Fan Loop

Integration: 500s  
Band: 10°F

### Heat/Cool Delay

Time delay between heating, cooling &/or economizer modes. Delay: 180s

### Unoccupied Mode Setup

Type: Cycle Supply Fan  
Source: Input ID6  
Heat Off Delay: 60s  
Open OA damper during unocc cycle?: NO

### Unocc Override Setup

Contact: Momentary

### Damper Setup

Allow the dampers to open for: 10 seconds before starting the fans.

### Fan/Airflow Proving

Alarm delay: 30s  
(inputs ID1 & ID5)

### **THIS SCREEN ALLOWS ADJUSTMENT OF THE MODULATING HOT GAS REHEAT.**

*This screen appears if modulating hot gas reheat was provided (except heat pump).*

### **THIS SCREEN ALLOWS ADJUSTMENT OF THE SUPPLY RESET PI CONTROL LOOP, FOR ROOM TEMP CONTROL.**

*This screen only appears if a Room Temp Sensor is wired to the controller.*

The controller utilizes a PI loop control for supply reset based on room temp. This allows for less sporadic changes in supply air temperature, resulting in a smooth reaction to changing conditions. To speed up reaction time, decrease the integration time. For slower reaction time, increase the integration time. When making adjustments, make them in small increments and test the system to determine if the new setting is adequate prior to further adjustment. The band is the range that the integration will occur between.

### **THIS SCREEN ALLOWS ADJUSTMENT OF SINGLE ZONE OPERATING DIAMETERS.**

*This screen appears if single zone operation is selected.*

The controller modulates both the discharge temperature and supply fan with respect to the heating and cooling loads in the space. In heating mode the controller will not begin to ramp up the fan until the supply discharge setpt is at least 5° (adj) above the room setpt. In cooling mode the fan will begin to ramp up only after the cooling is at 100% load. The PI parameters for adjusting that loop are adjustable here.

### **THIS SCREEN ALLOWS ADJUSTMENT OF THE DELAY BETWEEN HEAT AND COOL MODES.**

This time delay prevents short cycling between heating, cooling and/or economizer modes.

### **THIS SCREEN DISPLAYS ADDITIONAL PARAMETERS THAT MAY BE USED DURING UNOCCUPIED FAN CYCLING.**

After the unoccupied heating set point has been satisfied, the supply fan will continue to run for the heat off delay.

On 100% OA units, the OA damper can be configured to open to allow unoccupied fan cycling.

### **THIS SCREEN ALLOWS THE USER TO CHANGE THE TEMPORARY OCCUPANCY OVERRIDE CONTACT FROM MOMENTARY TO MAINTAINED.**

The default temporary occupancy override functionality is a momentary contact at ID6 that will override unoccupied mode for a user adjustable 1, 2, or 3 hours. This screen allows the user to change the setting and allow the unit to override unoccupied mode as long as the contact at ID6 is closed. This works well in application that have a motion detector, rotary timers, etc.

### **THIS SCREEN ALLOWS ADJUSTMENT OF THE FAN START DELAY.**

This timer allows the damper time to open before the fan start sequence begins. This prevents the fans from having to overcome higher static pressure when the damper(s) are opening. **(Factory Default = 10 seconds)**

### **THIS SCREEN ALLOWS ADJUSTMENT OF THE FAN AIRFLOW PROVING SWITCH TIME DELAY.**

Since the unit is only part of a complete system, the airflow(s) may momentarily change (ie. If a downstream damper closes). This delay is intended to prevent false loss of airflow alarms. **(Factory Default = 30 seconds)**

### Fan Delay

Time delay between starting of supply & exhaust fans.  
Fan delay: 15s

### Wheel Rotation Sensor

Alarm delay:  
(input ID3) 30s

### CO2 Controller

Integration: 600s  
Band 500PPM

### Duct Pressure Controller

Integration: 15s  
Band 5.00"wc  
Min On Time: 30s  
Overshoot Limit: YES  
Hi Limit Diff: 0.50"wc

### Building Ps Controller

Integration: 200s  
Band .100"wc

### Max Ventilation

Enable Max Vent: No  
2 Spd Fan: On  
2 Pos Damper: Off

### **THIS SCREEN ALLOWS ADJUSTMENT OF THE TIME DELAY BEFORE THE EXHAUST FAN WHEN THE SUPPLY FAN STARTS.**

*This screen only appears if an energy wheel was provided with the unit.*

The delay between the starting of supply and exhaust fans reduces the startup amp draw of the unit. The exhaust fan engages first, allowing the energy wheel to see space temperature conditions prior to the supply fan engaging. This allows the wheel to provide maximum preconditioning of the outdoor air. This also minimizes the potential of extreme outdoor air temperatures being supplied to the space, prior to the cooling or heating engaging.

### **THIS SCREEN ALLOWS ADJUSTMENT OF THE TIME DELAY FOR WHEEL ROTATION ALARM.**

*This screen only appears if an energy wheel was provided with the unit.*

Similar to the fan/airflow proving switch alarm, the energy wheel rotation alarm delay allows time to elapse prior to the controller showing an alarm. The delay prevents a false alarm from occurring if the sensor does not sense the wheel rotation for the allotted time.

### **THIS SCREEN ALLOWS ADJUSTMENT OF THE CO2 CONTROL LOOP.**

*This screen only appears if unit is controlled by a CO2 sensor.*

The controller utilizes a PI loop control for CO2 control. To speed up reaction time, decrease the integration time. For slower reaction time, increase the integration time. For less overshoot, increase the band. When making adjustments, make them in small increments and test the system to determine if the new setting is adequate prior to further adjustment.

### **THIS SCREEN ALLOWS ADJUSTMENT OF THE DUCT PRESSURE CONTROL LOOP.**

*This screen only appears if equipped with a duct pressure sensor.*

The controller utilizes a PI loop control for duct pressure control. To speed up reaction time, decrease the integration time. For slower reaction time, increase the integration time. For less overshoot, increase the band. When making adjustments, make them in small increments and test the system to determine if the new setting is adequate prior to further adjustment.

To allow the duct pressure to stabilize, the supply fan will remain at minimum speed for Min On Time. This prevents unnecessary overshoot at start-up.

To minimize excessive duct pressurization, the overshoot limit can be enabled. This will allow the user to enter an offset from the duct pressure set point. If the duct pressure exceeds the set point by the value of Hi Limit Diff (**Factory Default = 0.50 inch wc**), the supply fan will reset to its minimum speed.

**WARNING: MECHANICAL OVER-PRESSURIZATION SHOULD BE PROVIDED!**

### **THIS SCREEN ALLOWS ADJUSTMENT OF THE BUILDING PRESSURE CONTROL LOOP.**

*This screen only appears if unit is equipped with a building pressure sensor.*

The controller utilizes a PI loop control for building pressure control. To speed up the reaction time, decrease the integration time. For slower reaction time, increase the integration time. For less overshoot, increase the band. When making adjustments, make them in small increments and test the system to determine if the new setting is adequate prior to further adjustment.

### **THIS SCREEN ALLOWS THE USER TO ENABLE THE MAX VENTILATION SEQUENCE.**

*This screen only appears if modulating/2-speed fan or modulating/2-position damper operation was supplied with the unit.*

2-speed fan and/or 2-speed damper operation allows the user to send the fan and/or damper to a higher operating position through a digital input to the controller. Maximum ventilation is a sequence that will allow the digital input contact closer to bring the unit out of unoccupied mode. During this operation, the unit will run with the fan and/or damper at the 2-position or 2-speed set point for the duration of the contact closure.

Unit Off Protection	
Enable when OA < 40°F	
Hot Water: Enable	
Open HW Value:30%	
Chilled Water: Disable	

I/O Screens	
Enable all I/O screens?	Yes

Temperature Scale	
Select: Fahrenheit	
Display Properties	
Buzzer:	Disable
Backlight:	Always On
Timeout:	300s

**H.  Manufacturer**  
d. Initialization

Factory Settings	
	
Save?	No
Restore?	No

New Password	
	
Insert new manufacturer password (PW2):	0000

Initialization	
DEFAULT INSTALLATION	
Erase user settings and install global default values:	No

***THIS SCREEN ALLOWS THE USER TO ENABLE "UNIT OFF PROTECTION."***

*This screen only appears if hot water heating and/or cold water cooling is supplied with the unit.*

Unit off protection allows the unit to open the hot water and cold water valves to a preset position when the unit is off and the outdoor air is below the specified set point. This will keep water moving in the coils, to reduce the chance of freezing the coils.

***THIS SCREEN ENABLES THE VISIBILITY OF ALL I/O RELATED SCREENS.***

The controller automatically hides screens related to irrelevant I/O points. Enabling this functionality will give the user visibility of all I/O related screens and will also make these values available for monitoring on a BMS.

***THIS SCREEN ALLOWS THE USER TO ADJUST WHAT UNIT SYSTEM THE CONTROLLER SHOULD DISPLAY AND SOME OTHER DISPLAY PROPERTIES.***

The temperature unit of measurement can either be set to Fahrenheit or Celsius. If using Celsius, the user will need to manually convert the factory default parameters in each menu.

The display buzzer is only applicable when an optional remote interface panel is attached to the controller. If an alarm were to occur, the remote display panel would begin buzzing loudly (if the buzzer was enabled) and would show the alarm status.

The controller and/or remote display LED backlight can be configured to shut off after the Timeout period. Otherwise, the LED backlight will always be on.

The **Initialization Menu** allows the user to save and restore the controllers default parameters. The controller can be restored with either the Manufacturer's default parameters from shipment, or an unconfigured factory default.

***THIS SCREEN ALLOWS THE USER TO SAVE AND RESTORE THE FACTORY DEFAULT PARAMETERS STORED IN MEMORY.***

The factory settings include the factory default parameters and the unit setup code. If the user would like to restore to these parameters, move the cursor to the Restore position and change to yes.

***THIS SCREEN ALLOWS THE USER TO CHANGE THE MANUFACTURER PASSWORD (PW2)***

***THIS SCREEN ALLOWS THE USER TO RESTORE BACK TO THE ORIGINAL FACTORY DEFAULT PARAMETERS.***

Restoring to the original default parameters will result in a non-customized controller. The user should not restore to these settings unless instructed by the factory.

## Points List • LonWorks®

Type	NV_Index/ Bit	Name NV	Type NV	Read (Unit to BMS) Write (BMS to unit)	Description
Analog	23	nvoOutsideTemp	105	Read	Outdoor Air Temp (###.##°F)
Analog	3	nviOutsideTemp	105	Write*	Writeable Outdoor Air Temp (###.##°F) (*To write enable point. See pg. 21)
Analog	24	nvoSupplyAirTemp	105	Read	Supply Air Temp (###.##°F)
Analog	25	nvoColdCoilDisch	105	Read	Cold Coil Temp (###.##°F)
Analog	26	nvoRoomTemp	105	Read	Room AirTemp (if installed) (###.##°F)
Analog	4	nviRoomTemp	105	Write*	Writeable Room AirTemp (if installed) (###.##°F) (*To write enable point. See pg. 21)
Analog	27	nvoOA_Humidity	81	Read	Outdoor Relative Humidity (###.##%)
Analog	5	nviOAHumidity	81	Write*	Writeable Outdoor Relative Humidity (###.##%) (*To write enable point. See pg. 21)
Analog	28	nvoRoomHumidity	81	Read	Room Relative Humidity (###.##%)
Analog	6	nviRoomHumidity	81	Write*	Writeable Room Relative Humidity (###.##%) (*To write enable point. See pg. 21)
Analog	7	nviTempSetPt	105	Write	Temperature SetPt (read/write) (###.##F) (See Set Point Menu)
Analog	29	nvoActiveTempSP	105	Read	Active Temperature Set Point (###.##F)
Analog	8	nviDehumidSetPt	81	Write	Dehumidification SetPt (write) (##.##F, ##.##%) (See Set Point Menu)
Integer	34	nvoStatus	8	Read	Note 1 (See below)
Integer	35	nvoHeating	81	Read	Heater output (0-100%)
Integer	36	nvoCooling	81	Read	Cooling output (0-100%)
Integer	37	nvoWheel	81	Read	Energy recovery wheel speed (0-100%)
Integer	38	nvoReheat	81	Read	Hot gas reheat output (0-100%)
Integer	39	nvoCO2_Level	29	Read	CO2 Levels (ppm)
Integer	10	nviCO2_SetPt	29	Write	CO2 Set Point (ppm)
Integer	40	nvoSupVFDSP	81	Read	Supply Fan VFD Speed (0-100%)
Integer	11	nviSF_SetPt	81	Write	Supply Fan VFD Set Point (0-100%)
Integer	41	nvoExhVFDSP	81	Read	Exhaust Fan VFD Speed (0-100%)
Integer	12	nviEF_SetPt	81	Write	Exhaust Fan VFD Set Point (0-100%)
Integer	42	nvoOADamperPos	81	Read	Outdoor Damper Position (0-100%)
Integer	13	nviOADamperSetPt	81	Write	Minimum OA Damper Position (0-100%)
Integer	43	nvoDuctPressure	8	Read	Supply Duct Pressure (value/100=###" WC)
Integer	14	nviDuctPsSetPt	8	Write	Supply Duct Pressure Set Point (value/100=###" WC)
Integer	44	nvoBldgPressure	9	Read	Building Pressure (value/1000 = 0.###" WC)
Integer	15	nviBldgPsSetPt	9	Write	Building Pressure Set Point (value/1000 = 0.###" WC)
Integer	16	nviOccUnocc	8	Write	Occupied/unoccupied command (0=occupied, 1=unoccupied, 2=MWU)
Integer	45	nvoIG_Alarm	8	Read	IG Alarm - For alarm detail, Convert to binary (See IG Alarm chart below)
<b>pCOe Analog Variables</b>					
Analog	37	nvoAux_AI1	9	Read	pCOe Analog Input Probe Value 1
Analog	38	nvoAux_AI2	9	Read	pCOe Analog Input Probe Value 2
Analog	39	nvoAux_AI3	9	Read	pCOe Analog Input Probe Value 3
Analog	40	nvoAux_AI4	9	Read	pCOe Analog Input Probe Value 4
Analog	9	nviAux_AO1	81	Write	pCOe Auxillary Analog Out (0-10V)

IG Alarm (Ref. IG_Alarm point 1019)				
Bit 0	Bit 1	Bit 2	Bit 3	Bit 4
No Flame	Ignition Controller	Max Retries	High Limit	IG Furnace Offline

**Note 1: Unit Status Index**

0 System Off	5 System On	10 System On - Economizer & Cooling	15 Unoccupied - Heating	20 Remote off
1 Initial Delay	6 Defrost Mode Active	11 System On - Dehumidifying	16 Unoccupied - Cooling	21 Alarm
2 Opening Dampers	7 System On - Economizer	12 System On - Dehumidifying & Reheat	17 Unoccupied -Dehumidifying	22 Temp Occupied
3 Exhaust Fan Starting	8 System On - Heating	13 Unoccupied - Unit off	18 Unoccupied -Dehumid&Reheat	23 Max Ventilation
4 Supply Fan Starting	9 System On - Cooling	14 Unoccupied - Unit on	19 Manual Override	24 Unit Off Protection



## Points List • LonWorks®

Type	NV_Index/Bit	Name NV	Type NV	Read (Unit to BMS) Write (BMS to unit)	Description
Digital	46	nvoOnOffStat	95	Read	Unit ON/OFF status
Digital	47	nvoSupplyFan	95	Read	Supply fan status
Digital	48	nvoExhaustFan	95	Read	Exhaust fan status
Digital	49	nvoOccupancyStat	95	Read	Occupancy Status (0=Unoccupied, 1=Occupied)
Digital	50	nvoStageComp1	95	Read	Stage Compressor #1 status
Digital	51	nvoStageComp2	95	Read	Stage Compressor #2 status
Digital	52	nvoDefrostMode	95	Read	Defrost mode status
Digital	53	nvoDigScrollStat	95	Read	Digital Scroll status
Digital	17	nviStartStop	95	Write	Unit start/stop command
Digital	18	nviResetAlarms	95	Write	Reset alarms command
Digital	54	nvoStageComp3	95	Read	Stage Compressor #3 status
Digital	55	nvoStageComp4	95	Read	Stage Compressor #4 status
Digital	56	nvoGlobalAlarm	95	Read	Global alarm indication (active when there is at least one alarm)
	57	nvoAlarms	83		Alarms
Digital	(LSB) bit0	SupplyFanAlm		Read	Supply airflow proving alarm
Digital	bit1	WhlPressurAlm		Read	High wheel pressure (high airflow or dirty wheel)
Digital	bit2	WhlRotateAlm		Read	Wheel rotation alarm
Digital	bit3	ExhaustFanAlm		Read	Exhaust airflow proving alarm
Digital	bit4	FilterAlm		Read	Dirty filter alarm
Digital	bit5	CompTripAlm		Read	Compressor trip alarm
Digital	bit6	SupplyTempAlm		Read	Supply air temperature low limit alarm
	58	SensorAlarm	95		A sensor has failed
Digital	(LSB) bit0			Read	Sensor#1 out of range (outside air temperature)
Digital	bit1			Read	Sensor#2 out of range (supply air temperature)
Digital	bit2			Read	Sensor#3 out of range (cold coil leaving air temperature)
Digital	bit3			Read	Sensor#4 out of range (room temperature)
Digital	bit4			Read	Sensor#5 out of range (room humidity)
Digital	bit5			Read	Sensor#6 out of range (outdoor humidity)
Digital	bit6			Read	Sensor#7 out of range (building pressure sensor)
Digital	bit7			Read	Sensor#8 out of range (duct pressure sensor)
Digital	bit8			Read	Sensor#9 out of range (CO2 sensor)
Digital	bit9			Read	Sensor#10 out of range (auxiliary temp)
<b>pCOe Digital Variables</b>					
Digital	52	nvoAux_DI1	95	Read	pCOe Auxillary Digital Input1
Digital	53	nvoAux_DI2	95	Read	pCOe Auxillary Digital Input2
Digital	54	nvoAux_DI3	95	Read	pCOe Auxillary Digital Input3
Digital	55	nvoAux_DI4	95	Read	pCOe Auxillary Digital Input4
Digital	21	nviAux_DO1	95	Read/Write	pCOe Auxillary Digital Output1
Digital	22	nviAux_DO2	95	Read/Write	pCOe Auxillary Digital Output2

## Points List • Modbus/BACnet®

Type	BACnet Device Instance: 77000 (default) Analog = AV, Integer = AV, Digital = BV			Modbus Address: 1	Read Write	Description
	Instance	Name	Units	Register		
Analog	1	Outside_Air_Temp	°F	40002	R/W*	Outdoor Air Temp (###.°F) (*To write enable point. See pg. 21)
Analog	2	Supply_Air_Temp	°F	40003	R	Supply Air Temp (###.°F)
Analog	3	Cold_Coil_Leaving_Temp	°F	40004	R	Cold Coil Temp (###.°F)
Analog	4	Room_Air_Temp	°F	40005	R/W*	Room AirTemp (if installed) (###.°F) (*To write enable point. See pg. 21)
Analog	5	Outside_Humidity	percent	40006	R/W*	Outdoor Relative Humidity (###.%) (*To write enable point. See pg. 21)
Analog	6	Room_Humidity	percent	40007	R/W*	Room Relative Humidity (###.%) (*To write enable point. See pg. 21)
Analog	11	Temp_Set_Point	°F	40012	R/W	Temperature SetPt (read/write) (###.°F) (See Set Point Menu)
Analog	12	Active_Temp_Set_Point	°F	40013	R	Active Temperature Set Point (###.°F)
Analog	13	Dehumid_Set_Point	percent	40014	R/W	Dehumidification SetPt (read/write) (##.%, ##.%) (See Set Point Menu)
Integer	1001	Unit_Status_Index	no-units	45003	R	Note 1 (See below)
Integer	1002	Heating_Control_Loop	percent	45004	R	Heater output (0-100%)
Integer	1003	Cooling_Control_Loop	percent	45005	R	Cooling output (0-100%)
Integer	1004	Energy_Wheel_Speed	percent	45006	R	Energy recovery wheel speed (0-100%)
Integer	1005	Reheat_Control_Loop	percent	45007	R	Hot gas reheat output (0-100%)
Integer	1006	CO2_Level	ppm	45008	R	CO2 Levels (ppm)
Integer	1007	CO2_Set_Point	ppm	45009	R/W	CO2 Set Point (ppm)
Integer	1008	Supply_VFD_Speed	percent	45010	R	Supply Fan VFD Speed (0-100%)
Integer	1009	Supply_VFD_SetPt	percent	45011	R/W	Supply Fan VFD Set Point (0-100%)
Integer	1010	Exhaust_VFD_Speed	percent	45012	R	Exhaust Fan VFD Speed (0-100%)
Integer	1011	Exhaust_VFD_SetPt	percent	45013	R/W	Exhaust Fan VFD Set Point (0-100%)
Integer	1012	OA_Damper_Position	percent	45014	R	Outdoor Damper Position (0-100%)
Integer	1013	OA_Damper_SetPt	percent	45015	R/W	Minimum OA Damper Position (0-100%)
Integer	1014	Duct_Pressure	no-units	45016	R	Supply Duct Pressure (value/100=###" WC)
Integer	1015	Duct_Pressure_SetPt	no-units	45017	R/W	Supply Duct Pressure Set Point (value/100=###" WC)
Integer	1016	Building_Pressure	no-units	45018	R	Building Pressure (value/1000 = 0.###" WC)
Integer	1017	Building_Pressure_SetPt	no-units	45019	R/W	Building Pressure Set Point (value/1000 = 0.###" WC)
Integer	1018	Occupied_Unoccupied	no-units	45020	R/W	Occupied/unoccupied command (0=occupied, 1-unoccupied, 2-MWU)
Integer	1019	IG_Alarm	no-units	45021	R	IG Alarm - For alarm detail, Convert to binary (See IG Alarm chart below)
Integer	1021	Airflow_CFM1	no-units	45023	R	Airflow monitoring station 1 CFM value
Integer	1022	Airflow_CFM2	no-units	45024	R	Airflow monitoring station 2 CFM value
Integer	1023	Airflow_CFM3	no-units	45025	R	Airflow monitoring station 3 CFM value
Integer	1024	User_Def_Exh_SetPt	no-units	45026	R/W	User defined exhaust fan control set point
Integer	1025	User_Def_Exh_Input	no-units	45027	R	User defined exhaust fan control input value
<b>pCOe Analog Variables</b>						
Analog	40022	21	pCOe_Analog_Input_Probe_Value_1	°F or Percent	R	pCOe Analog Input Probe Value 1
Analog	40023	22	pCOe_Analog_Input_Probe_Value_2	°F or Percent	R	pCOe Analog Input Probe Value 2
Analog	40024	23	pCOe_Analog_Input_Probe_Value_3	°F or Percent	R	pCOe Analog Input Probe Value 3
Analog	40025	24	pCOe_Analog_Input_Probe_Value_4	°F or Percent	R	pCOe Analog Input Probe Value 4
Analog	40026	25	pCOe_Analog_Out	percent	R/W	pCOe Auxillary Analog Out (0-10V)

### IG Alarm (Ref. IG\_Alarm point 1019)

Bit 0	Bit 1	Bit 2	Bit 3	Bit 4
No Flame	Ignition Controller	Max Retries	High Limit	IG Furnace Offline

#### Note 1: Unit Status Index

0 System Off	5 System On	10 System On - Economizer & Cooling	15 Unoccupied - Heating	20 Remote off
1 Initial Delay	6 Defrost Mode Active	11 System On - Dehumidifying	16 Unoccupied - Cooling	21 Alarm
2 Opening Dampers	7 System On - Economizer	12 System On - Dehumidifying & Reheat	17 Unoccupied -Dehumidifying	22 Temp Occupied
3 Exhaust Fan Starting	8 System On - Heating	13 Unoccupied - Unit off	18 Unoccupied -Dehumid&Reheat	23 Max Ventilation
4 Supply Fan Starting	9 System On - Cooling	14 Unoccupied - Unit on	19 Manual Override	24 Unit Off Protection



## Points List • Modbus/BACnet®

Type	BACnet Device Instance: 77000 (default) Analog = AV, Integer = AV, Digital = BV				Modbus Address: 1	Read Write	Description
			Inactive_ Text	Active_Text			
Digital	1	On_Off_Stat	Off	On	10002	R	Unit ON/OFF status
Digital	2	Supply_Fan_Status	Off	On	10003	R	Supply fan status
Digital	3	Exhaust_Fan_Status	Off	On	10004	R	Exhaust fan status
Digital	4	Occupancy_Status	Unoccupied	Occupied	10005	R	Occupancy Status (0=Unoccupied, 1=Occupied)
Digital	5	Stage_Compressor1_Status	Off	On	10006	R	Stage Compressor #1 status
Digital	6	Stage_Compressor2_Status	Off	On	10007	R	Stage Compressor #2 status
Digital	7	Defrost_Mode	Off	On	10008	R	Defrost mode status
Digital	8	Digital_Scroll_Status	Off	On	10009	R	Digital Scroll status
Digital	10	Unit_Start_Stop	Stop	Start	10011	R/W	Unit start/stop command
Digital	11	Reset_Alarms	Don't Reset	Reset Alarms	10012	R/W	Reset alarms command
Digital	13	Stage_Compressor3_Status	Off	On	10014	R	Stage Compressor #3 status
Digital	14	Stage_Compressor4_Status	Off	On	10015	R	Stage Compressor #4 status
Digital	20	Global_Alarm	Off	Alarm	10021	R	Global alarm indication (active when there is at least one alarm)
Digital	21	Supply_air_proving	Off	Alarm	10022	R	Supply airflow proving alarm
Digital	22	High_Wheel_Pressure	Off	Alarm	10023	R	High wheel pressure (high airflow or dirty wheel)
Digital	23	Wheel_Rotation	Off	Alarm	10024	R	Wheel rotation alarm
Digital	24	Exhaust_air_proving	Off	Alarm	10025	R	Exhaust airflow proving alarm
Digital	25	Dirty_filter	Off	Alarm	10026	R	Dirty filter alarm
Digital	26	Compressor_trip	Off	Alarm	10027	R	Compressor trip alarm
Digital	27	Supply_air_low_limit	Off	Alarm	10028	R	Supply air temperature low limit alarm
Digital	28	Sensor1_out_of_range	Off	Alarm	10029	R	Sensor#1 out of range (outside air temperature)
Digital	29	Sensor2_out_of_range	Off	Alarm	10030	R	Sensor#2 out of range (supply air temperature)
Digital	30	Sensor3_out_of_range	Off	Alarm	10031	R	Sensor#3 out of range (cold coil leaving air temperature)
Digital	31	Sensor4_out_of_range	Off	Alarm	10032	R	Sensor#4 out of range (room temperature)
Digital	32	Sensor5_out_of_range	Off	Alarm	10033	R	Sensor#5 out of range (room humidity)
Digital	33	Sensor6_out_of_range	Off	Alarm	10034	R	Sensor#6 out of range (outdoor humidity)
Digital	34	Sensor7_out_of_range	Off	Alarm	10035	R	Sensor#7 out of range (building pressure sensor)
Digital	35	Sensor8_out_of_range	Off	Alarm	10036	R	Sensor#8 out of range (duct pressure sensor)
Digital	36	Sensor9_out_of_range	Off	Alarm	10037	R	Sensor#9 out of range (CO2 sensor)
Digital	37	Sensor10_out_of_range	Off	Alarm	10038	R	Sensor#10 out of range (auxiliary temp)
pCOe Analog Variables							
Digital	51	Aux_DI1	Off	On	10052	R	pCOe Auxiliary Digital Input1
Digital	52	Aux_DI2	Off	On	10053	R	pCOe Auxiliary Digital Input2
Digital	53	Aux_DI3	Off	On	10054	R	pCOe Auxiliary Digital Input3
Digital	54	Aux_DI4	Off	On	10055	R	pCOe Auxiliary Digital Input4
Digital	55	Aux_DO1	Off	On	10056	R/W	pCOe Auxiliary Digital Output1
Digital	56	Aux_DO2	Off	On	10057	R/W	pCOe Auxiliary Digital Output2
Digital	57	Aux_DO3	Off	On	10058	R/W	pCOe Auxiliary Digital Output3
Digital	58	Aux_DO4	Off	On	10059	R/W	pCOe Auxiliary Digital Output4

## Remote Display (pGD1)

The pGD1 is an optional remote display for use with manufacturer's microprocessor controllers. The remote display allows for remote monitoring and adjustment of parameters of the unit mounted controller. The remote display allows identical access to menus and screens as the unit mounted controller display.



Specifications	
Carel Model	PGD1000W00
Power Supply	Power supplied from unit controller through RJ25 cable
Max distance from unit controller	150 feet
Required Cable	6P6C RJ25/RJ12 Cable (straight)
Operating Conditions	-4°F to 140°F, 90%RH (non-condensing)
Display Type	Backlit LED with lighted buttons

### Installation

The remote display connects to the unit mounted controller through a six-wire RJ25 or RJ12 telephone cable (straight). When ordered from the factory, a 10 ft. cable is provided with the remote display. The display and cable can be used to assist with start-up and maintenance.

### Connecting Cable

If mounted remotely, the factory cable can either be extended or replaced with a longer cable to obtain the necessary distance. The resulting cable connections should be a "straight through cable," where pins on one end correspond identically to the pins on the opposite end. If making your own cable, use the same pin-out for each end.

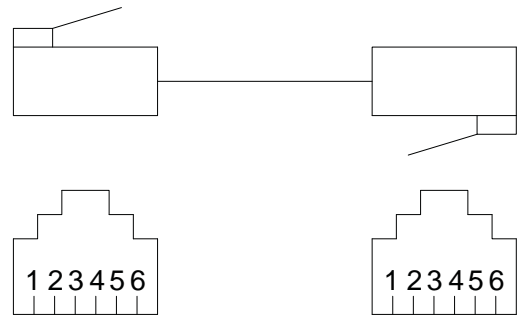

## NTC Temperature Sensor Chart

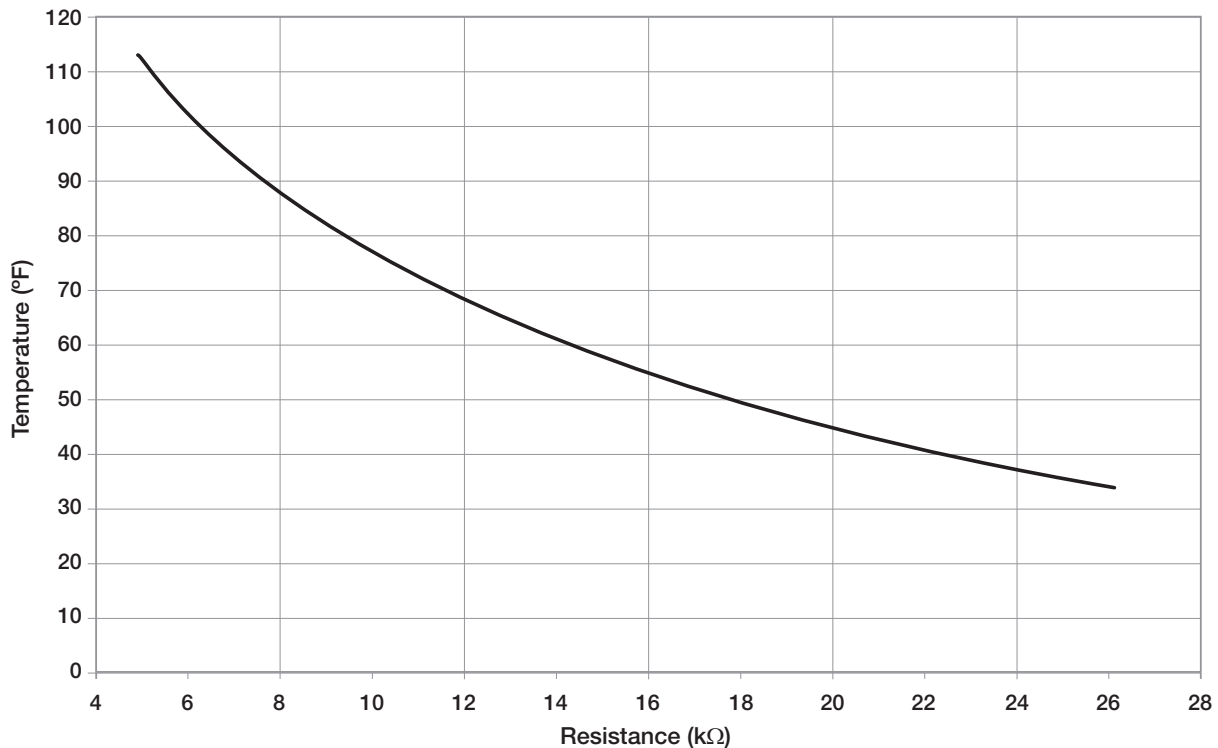

## Economizer Commissioning Tool

### Service Menu

- a. Information
- b. Overrides
- c. BMS Config



### I/O Manual Control

- E. Components
- A. Analog
- B. Digital Inputs



### Analog Input

```

Outside Temperature
ManualControl U005:   ON
ManualPosition:      57.1
Value                 57.1
    
```

This tool includes information on commissioning the economizer functionality of the DDC controller. The instructions below are based on factory default values. Results may vary depending on the current settings of the unit.

The unit may delay up to three (3) minutes before going into economizer mode.

Commissioning the economizer functionality is done by overriding the outdoor air and supply air conditions to simulate a scenario in which economizer is used for cooling. NOTE: Overriding the physical inputs can be dangerous to the equipment. Use caution when adjusting these values and RESET POWER WHEN FINISHED!!!

The table below indicates the necessary override values for the corresponding sensor to simulate economizer. The 'Supply Temp Source' can be found on the 'Supply Temp Set Point' screen. Navigate to the Analog Inputs Override menu (Service -> Overrides -> Analog Inputs) and refer to the table below for the appropriate override value.

In situations where mechanical cooling is available during economizer, increase the outdoor air temperature to 57.1° F to unlock the cooling.

Econ Type	Supply Temp Source	Outdoor Air Temp	Cold Coil Temp	Discharge Temp	Room Air Temp	Outdoor Air Relative Humidity
<b>Temp Only</b>	Outdoor Air Reset	53.0°F	75.0°F	75.0°F	-	-
	Room Air Reset	53.0°F	75.0°F	75.0°F	75.0°F	-
	Local/BMS	53.0°F	75.0°F	75.0°F	-	-
<b>Temp and Dew Point</b>	Outdoor Air Reset	53.0°F	75.0°F	75.0°F	-	30%
	Room Air Reset	53.0°F	75.0°F	75.0°F	75.0°F	30%
	Local/BMS	53.0°F	75.0°F	75.0°F	-	30%

## Troubleshooting

Display is hard to read.	Unit Controller Display: Hold  ESC and  ENTER at the same time, while pressing  DOWN or  UP to adjust display contrast. Remote Display: Hold  ALARM,  PRG, and  ESC at the same time, while pressing  DOWN or  UP to adjust display contrast.
Remote display panel displays "NO LINK" or is blank.	Hold  DOWN,  UP and  ENTER for 4 seconds. Set the display address to 32. The display requires a standard 24 AWG six conductor phone cable connected to the unit controller.
Red alarm button is flashing.	Press the  ALARM button to review and clear unit alarms. Enter the DATA LOGGER menu to view previous alarms.
Controller resets itself or is not on.	Check the supply voltage to the controller at terminals G-G0. The board requires 24VAC. Check the 24VAC transformer in the unit control center.
Menus are locked with a password.	The factory default Manufacturer Password = 1000. The factory default Service Password = 1000.
Temperature sensor failure.	Check the analog input terminal block (labeled terminals B1, B2, B3, etc) for loose wires. Disconnect temperature sensors to check sensor resistance.

The card is loaded with the following default BACnet MSTP parameters.

Parameter	Factory	Minimum	Maximum
Device Instance	77000	0	4194303
Station Address	0	0	127
Max Master	127	0	127
Max Info Frames	20	0	255
Baudrate	38400	9600-19200-38400-76800	

### G. Service

#### c. BMS Config

To view the current parameters, go the **BMS Config** menu within the controller by pressing the  key.

#### BMS Configuration

Protocol: BACnet MSTP  
BACnet Plugin? YES

#### MSTP SETUP

Instance: 77000  
Baudrate 38400  
MAC Addr: 0  
MaxMasters: 127  
MaxInfoFrames: 20

#### NOTE: Example Only!

#### BACnet Read/Write

To save: Change  
To function: To write and update to Yes. Then cycle unit power to confirm write command.  
Function: Read  
Update? YES

To access the **BMS Config** sub-menu, enter the service-password (Default=1000).

**Protocol** must be **BACnet MSTP** and **BACnet Plugin** must be **YES**.

Press the  button arrow to view next screen.

Current BACnet MSTP parameters should be displayed. If values appear to be zero, follow the procedure below.

#### To read current settings:







1. Power on controller and allow several minutes to initialize.

2. Go to **BMS Config** menu and view BACnet Read/Write screen.

3. Change **Function** to **Read** and **Update?** to **YES**.

Current BACnet MSTP parameters should now be displayed in the BACnet MSTP SETUP screen. If all values appear to be zeros, consult the factory. (Make sure you have allowed several minutes for the controller to initialize). *\*Values may appear to be zero prior to setting the Function to READ.*

To change BACnet MSTP parameters:

1. Power on the controller and allow several minutes to initialize.
2. Go to **BMS Config** menu and view MSTP SETUP screen.
3. Move cursor to desired parameter by pressing the   buttons. Press  to select the parameter to change. Press the   buttons to adjust the parameter. Press  to save adjusted value.

4. Once desired parameters have been entered, go to BACnet Read/Write screen. Change **Function** to **Write** and **Update?** to **YES**.
5. Reboot the controller by cycling power to the unit. Allow several minutes for the controller to initialize.
6. View MSTP parameters. If changed values did not save, contact the factory.

The communication card is located in the **Serial Card** port on the face of the controller. The card includes two sets of LED lights for communication troubleshooting.

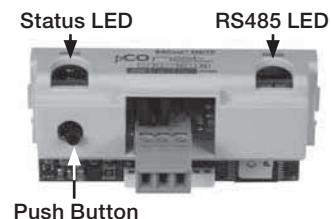

**Status LED:** Indicates the status of communication between the card and controller.

- Quick green-off-green if communication with controller is ok.
- Slow red-off-red if communication is not established.

**RS485 LED:** Indicates the status of communication with the BACnet MSTP network. Wait for 40 seconds to determine status of communication.

- Green with occasional red, communication is OK.
- Green and red both on, communications is not established.

### Communication Troubleshooting

See Carel Data sheet for more info.

If attempting to communicate with the controller over BACnet MSTP, refer to the card LEDs for system information.

#### **Status LED slow red blink**

- Confirm card is firmly plugged in.
- Confirm BMS Protocol is set to BACnet MSTP.

#### **RS485 LED green and red both on**

- Confirm system and card baudrate are the same.
- Confirm card Max Master is equal to or greater than the Station (MAC) Address of the Master with the highest address.

### Recalling Factory Parameters

Follow this procedure to revert to factory parameters for one power cycle. When restarted, the card will resume using the previous user parameters.

1. With controller off, hold the push button located on the BACnet MSTP card, while powering the controller back on.
2. Continue to hold the button, while watching the **Status LEDs**. Wait for the Status LEDs to blink red slowly, and release before the third slow flash.
3. Wait for about one minute for the factory parameters to be loaded.

**\*The BACnet IP/Eth card is configured for DHCP from the factory.**

To view the current parameters, go the **BMS Config** menu within the controller by pressing the  key.

**G.  Service**

c. BMS Config 

**BMS Configuration**

Protocol: BACnet IP/Eth  
BACnet Plugin? YES

**TCP/IP SETUP**

Instance: 77000  
IP set by: DHCP  
IP: 128.1.104.134  
Subnet: 255.255.000.000  
Gateway: 128.1.0.12

**NOTE: Example Only!**

**TCP/IP Setup**







DNS 1: 193.168.001.001  
DNS 2: 193.168.001.001  
Type: IP

**BACnet Read/Write**

To save: Change  
To function: To write and update to Yes. Then cycle unit power to confirm write command.  
Function: Read  
Update? YES

screen. If all values appear to be zeros, consult the factory. (Make sure you have allowed several minutes for the controller to initialize). **\*Values may appear to be zero prior to setting the Function to READ.**

To change BACnet TCP/IP parameters:

1. Power on the controller and allow several minutes to initialize.
2. Go to **BMS Config** menu and view TCP/IP SETUP screen.
3. Move cursor to desired parameter by pressing the   buttons. Press  to select the parameter to change. Press the   buttons to adjust the parameter. Press  to save adjusted value.
4. Once desired parameters have been entered, go to BACnet Read/Write screen. Change **Function** to **Write** and **Update?** to **YES**.
5. Reboot the controller by cycling power to the unit. Allow several minutes for the controller to initialize.
6. View TCP/IP parameters. If changed values did not save, contact the factory.

To access the **BMS Config** sub-menu, enter the service password (**Default=1000**).

**Protocol** must be **BACnet IP/Eth** and **BACnet Plugin** must be **YES**.

Press  arrow button to view next screen.

Current BACnet IP parameters should be displayed. If values appear to be zero, follow the procedure below.

To read current parameters:

1. Power on controller and allow several minutes to initialize.
2. Go to **BMS Config** menu and view BACnet Read/Write screen.
3. Change **Function** to **Read** and **Update?** to **YES**.

Current BACnet IP parameters should now be displayed in the BACnet TCP/IP SETUP

The communication card is located in the **Serial Card** port on the face of the controller. The card includes two sets of LED lights for communication troubleshooting.

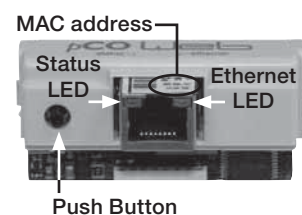

**Status LED:** Indicates the status of communication between the card and controller.

- Quick green-off-green if communication with controller is ok.
- Slow red-off-red if communication is not established.

**Ethernet LED:** Indicates the status of communication with the network. Wait for 40 seconds to determine status of communication.

- Flashing green, communication is OK.
- Steady red, communications is not established.

### Communication Troubleshooting

See Carel Data sheet for more info.

If attempting to communicate with the controller over BACnet IP/Eth, refer to the card LEDs for system information.

#### Status LED slow red blink

- Confirm card is firmly plugged in.
- Confirm BMS Protocol is set to BACnet IP/Eth.

#### Ethernet LED red on

- Confirm card is connected to the network.

### Recalling Factory Parameters

Follow this procedure to revert to factory parameters for one power cycle. When restarted, the card will resume using the previous user parameters.

Factory Default IP address: 172.16.0.1

1. With controller off, hold the push button located on the BACnet IP/Eth card, while powering the controller back on.
2. Continue to hold the button, while watching the **Status LED**. Wait for the Status LED to blink red slowly, and release before the third slow flash.
3. Wait for about one minute for the factory parameters to be loaded.
4. Follow the procedure to read the current parameters to confirm factory defaults have been loaded.

Factory pCOWeb Configuration	
Device Instance	77000
IP Address	172.16.0.1
Subnet Mask	255.255.0.0
User Datagram Protocol (UDP)	47808
Username	admin
Password	fadmin

## Appendix B: Room Thermostat Quick Start



The room thermostat gives users the ability to view the room temperature and relative humidity (optional) and control the active room set points from the adjustable display. The room thermostat also has the ability to send the unit into temporary occupied mode. It is also provides with the functionality to average up to 4 temperature readings through the microprocessor. The room thermostat is shipped loose with installation by others and is a Modbus connected device.



Room thermostat functions:

- Temporary occupancy override control
- Temperature and relative humidity monitoring
- Temperature and relative humidity set point adjustability
- Status icon on LCD display with push buttons
- Optional temperature monitoring up to 4 sensors

### Display

If more than one room thermostat is provided for averaging, only one room thermostat will be provided with a display and push buttons for adjustment.

**Adjusting SET POINT** - The default display will show the current temperature value for the room. Use the scroll button to index through additional sensor parameters. Parameters with the "SET POINT" icon displayed above the temperature display are adjustable. Use the Up/Down buttons to adjust the set point, and use the scroll button to view the next parameter or return to the normal display mode.

**Up/Down Button Function** - The Up/Down buttons are used to adjust editable parameters including the temperature and humidity set point.

**Override Button Function** - The display shows a person in the lower left corner of the display at all times. If the person is solid the unit is operating in occupied mode. If it is an outline of the person the unit is in unoccupied mode. By pushing the Override button when the unit is in unoccupied mode will allow a temporary override sequence to Occupied mode for a period of 1 to 3 hrs. (adjustable at the unit microprocessor).

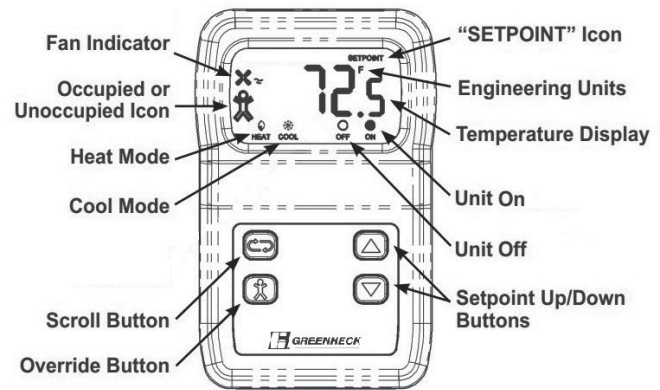

### Initial Setup and Communication Configuration

The Room Thermostat is a ModBus connected device There can be up to 3 additional ModBus temperature sensors added for room temperature averaging. The sensors must all be connected in a daisy chain configuration. See *Appendix E: ModBus Wiring* for more information.

T-Stat Config	
Modbus Address:	10
Online:	No
T-Stat Temp:	0.0°F
Number of T-Stats:	2

The microprocessor controller will be pre-configured for 1 Room Thermostat. If room temperature averaging is desired, additional field setup will be required both in the controller and on the ModBus room sensors. In the Controller, enter into the Manufacturing Menu, and enter into the Configuration Menu. Scroll down in the Configuration Menu into the T-Stat Config screen. Choose the number of room sensors being used (1-4) and adjust the Modbus device addresses on the following screens based on the number of sensors.

Each room sensor must have the dip switches adjusted on the back of the sensor to the corresponding switches shown in table 1. Once the address are set and the wires are connected the "Status" LED should be a steady green and the "Network" LED should be a quick blinking amber/green color.

### Status LED

**Green** - Indicates that the unit is operating properly.  
**Red** - Indicates that there is a problem with the unit.

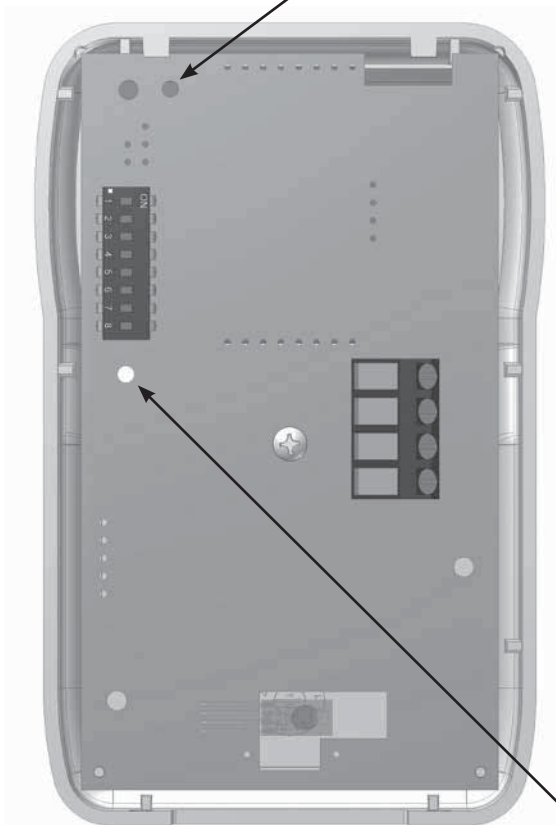

Terminal	Description
GND	Power Supply Ground (common to the controller)
Net B	RS485 network connection (Data -)
Net A	RS485 network connection (Data +)
Power	Power supply hot

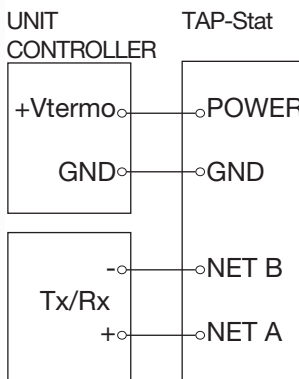

### Network LED

**Flashing Red Slowly** - Indicates that there has been no communications for 60 seconds.

**Flashing Green Slowly** - Indicates that there have been normal communications within the last 60 seconds.

**Flashing Green Slowly with Quick Red Flashes** - The quick red flashes indicate active communications.

Room Thermostat Modbus Address				
	T-Stat 1 (Display)	T-Stat 2	T-Stat 3	T-Stat 4
Address in Microprocessor	10	11	12	13
Dip Sw. Set on Stat	Sw 2 + Sw 8	Sw 1 + Sw 2 + Sw 8	Sw 4 + Sw 8	Sw 1 + Sw 4

## Baud Rate Setting

In order for the room thermostat to communicate with the microprocessor the correct baud rate must be set in the room thermostat. To set the baud rate the "PROG" dip switch on the back of the room thermostat must be flipped to the right side. Use the down arrow button to display P11 on the room thermostat. Push the scroll button and use the up and down buttons to adjust the baud rate to 192. Once 192 is displayed, push the scroll button again to save the setting. Once the setting is saved P11 should appear on the display. Flip the "PROG" dip switch on the back of the room thermostat back to the left. The room thermostat should communicate and be set back to normal mode.

## Occupancy Override Time Adjustment

If the occupancy override time needs to be adjusted, push the down arrow on the microprocessor control from the main menu screen when the unit is in unoccupied mode. Scroll down from the main screen to find the "Occupancy Override" screen. This screen provides the current status of the occupancy override and adjustment of the override time from 1 to 3 hours. If the occupancy override is enabled from the Room Thermostat or the Unit Microprocessor, it will override for the period of time set on this menu screen.

Occupancy Override	
Time Override:	Off
Override Time:	1hr
UNOCCUPIED-UNIT OFF	

## Appendix C: GreenTrol Airflow Monitoring Quick Start

### Airflow Measurement

Outdoor Air:	0cfm
Exhaust Air:	0cfm
More Information:	Yes

### Outdoor Airflow

Avg. Airflow:	0cfm
Avg. Temp:	0.0°F
Duct Area:	0.0 sq ft
Alarm:	None
Trouble:	No
Offline:	No
Address:	31

The GreenTrol airflow monitoring station measures airflow using advanced thermal dispersion technology. An integral LCD display provides a local indication of airflow measurement and device configuration. The airflow monitor also features Modbus communication allowing the main unit microprocessor to monitor the airflow as well. The GreenTrol also accepts up to two airflow probes for averaging.

GreenTrol Airflow Monitor functions:

- LCD readout of measured airflow
- Dual airflow probe averaging
- Modbus connectivity



## Display and Navigation

The LCD screen will by default show the current airflow that is being measured. To enter the menu to set up the monitoring station the user must remove the front cover of the GreenTrol to uncover the navigation buttons. Press and hold the UP and DOWN keys at the same time for 3 seconds to enter the menu.

**Enter Button Function** - The ENTER button allows the user to go into the selected menu or function as well as save the selected value.

**Up/Down Button Function** - The Up/Down buttons are used to navigate the manu and to change values in the menu.

**Esc Button Function** - The ESC button allows the user to exit the current menu or function.

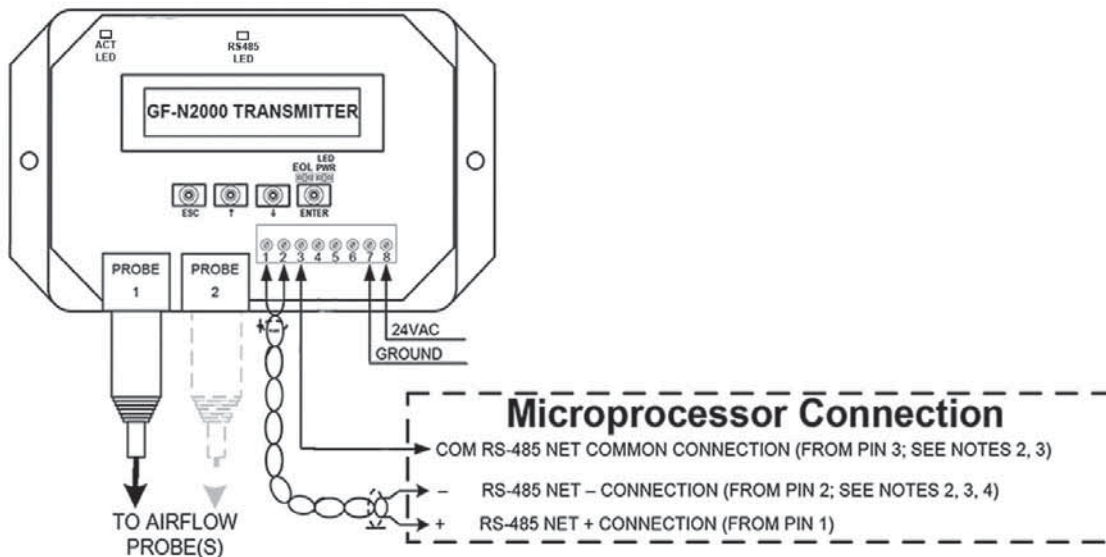



## Microprocessor Setup

The GreenTrol is a Modbus connected device. There can be up to 3 GreenTrol airflow monitoring stations connected to the microprocessor. The sensors must all be connected in a Daisy Chain configuration. See *Appendix E: ModBus Wiring* for more information.

The microprocessor controller will be pre-configured for the monitoring stations installed at the factory. If additional airflow monitoring is desired, additional field setup will be required both in the controller and on the airflow monitors

Airflow Setup	
Enable: Outdoor Airflow	themselves. To get into the setup in the Controller, enter into the Manufacturing Menu, and enter into the Configuration Menu. Scroll down in the Configuration Menu into the Airflow Setup screen. Up to 3 different airflow monitors can be enabled as either Outdoor Airflow, Supply Airflow, Exhaust Airflow, or Return Airflow. Once the airflow monitors are enabled in the "Airflow Setup" screen, the user can view the airflow in the main status screens.
Enable: Exhaust Airflow	
Enable: None	

To enable the airflow monitoring stations:

1. Go to manufacturer menu
2. Go to configuration
3. Scroll down to "Airflow Setup"
4. Enable the desired airflow monitoring stations.

Note: The ModBus addresses of each will be as follows from top to bottom.

Enable 1 = Addr 31

Enable 2 = Addr 32

Enable 3 = Addr 33

5. Now the microprocessor has been set up to communicate with the airflow monitoring stations. You are now ready to set up the airflow monitoring stations themselves.

## Airflow Monitor Setup

For the airflow monitor to communicate with the unit microprocess or the Modbus, parameters must be set up. Follow steps 1 thru 9 below to setup the Modbus communication.

1. Press the UP and DOWN keys at the same time for 3 seconds
2. When SETUP appears on the screen press ENTER
3. Scroll DOWN twice to the NETWORK menu and press ENTER
4. When NETOUT appears on the screen, press ENTER; when SET NETOUT appears on the screen, press ENTER again
5. Scroll UP or DOWN to set the NETOUT = MODBUS and then press ENTER
6. Scroll DOWN to NETADDR and press ENTER, when SET NETADDR appears on the screen press ENTER again
7. Scroll UP or DOWN to set the NET ADDR to the same address that was listed for thr airflow monitor in the microprocessor. For instance, the Outdoor Airflow Monitor screen above has an address of 31. Then press ENTER.
8. Scroll DOWN to NETBAUD and press ENTER, when SET NETBAUD appears on the screen, press ENTER again
9. Scroll UP or DOWN until NETBAUD = 19200, then press ENTER
10. Scroll down to PARITY and press ENTER, when SET PARITY appears on the screen press ENTER again
11. Scroll UP or DOWN until PARITY = NONE2, then press ENTER
12. Once the address is set and the communication wires are connected, "Status" LED should be a steady green and the "RS485" LED should be a quick blinking green LED.

## Appendix D: I/O Expansion Board (pCOe) Quick Start



The pCOe expansion board is an I/O module that can be used to monitor additional statuses within the unit or provide commands. The pCOe allows the user to view and control:

- 4 Digital Inputs
- 4 Digital Outputs
- 4 Analog Inputs
- 1 Analog Output

The inputs and outputs can be monitored and manually controlled either via the controller display or Building Management System. See Points List for detailed point information.

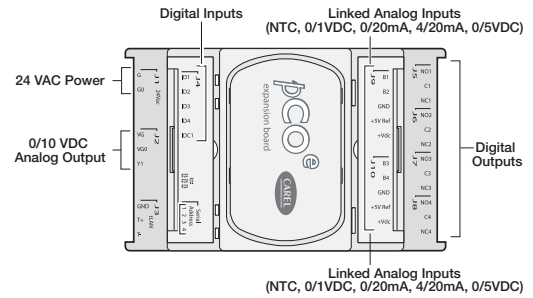

### Setup

In order for the controller to communicate with the pCOe, several parameters must be adjusted. If you have a pCOe installed from the factory, the controller is already set up for communication with the main controller.

Unit Expansion I/O	
Enable Expansion	Yes

**Enabling the pCOe in the Main Controller.** - To enable the pCOe expansion I/O module, go to **Manufacturer > Configuration**. You will have to enter the Manufacturer password (Default = 1000). Enabling the pCOe expansion module allows additional screens to appear in other menus (see below).

Analog Inputs	pCOe1
Aux AI Pair 1	
Channels: B1 & B2	
Type:	Carel NTC

**Configuring the pCOe Analog Inputs.** - The analog inputs are grouped in pairs (Channels B1-B2 and Channels B3-B4). Each pair must be configured as the same analog input type (Carel NTC, 0/1 VDC, 0/20 mA, 4/20 mA or 0/5 VDC).

To setup the analog inputs:

1. Go to **Manufacturer > I/O Configuration > Analog Inputs**.
2. Find the pCOe Analog input screens.
3. Select desired channels and input type. If only one channel is to be used, select the desired channel to prevent nuisance sensor alarms.

If using a non-Carel NTC type, scale the input to match the probe range.

Analog Input	pCOe1
Aux AI Pair 2	
Channels: B3 & B4	
Type:	4 . . 20 mA
B3 Min:	0.0
B3 Max:	10.0
B4 Min:	0.0
B4 Max:	10.0

Digital Inputs	pCOe1
Channel ID1:	Closed
Channel ID2:	Closed
Channel ID3:	Closed
Channel ID4:	Closed

**Viewing pCOe I/O Values.** - To view input values, go to the Input/Output menu.

The pCOe I/O values can be viewed on the BMS. The digital and analog outputs can be changed through the BMS. See Points List for more details.

Analog Inputs	pCOe1
Input B1:	32.0°F
Input B2:	32.0°F
Input B3:	0.0°F
Input B4:	0.0°F

Digital Outputs	pCOe1
Output NO1:	OFF
Output NO2:	OFF
Output NO3:	OFF
Output NO4:	OFF

Analog Outputs	pCOe1
Output Y1:	0.0vdc



# Appendix E: Factory ModBus Connections

## COMPONENTS MOUNTED AND WIRED BY FACTORY

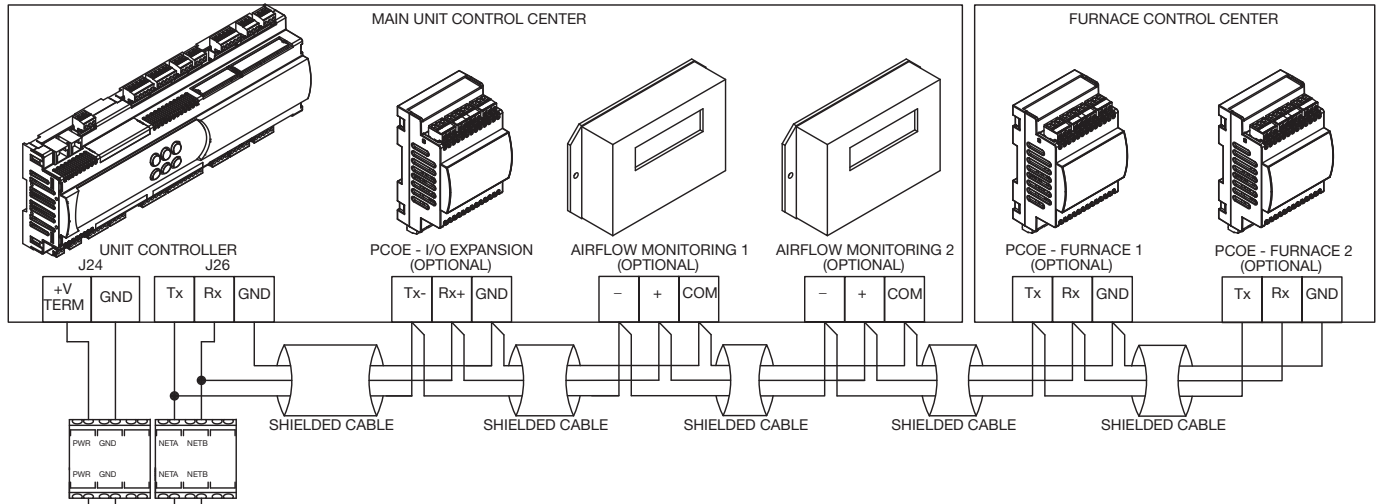

## COMPONENTS FIELD MOUNTED AND WIRED IN ROOM/SPACE

FIELD WIRING - - - - -  
FACTORY WIRING - - - - -

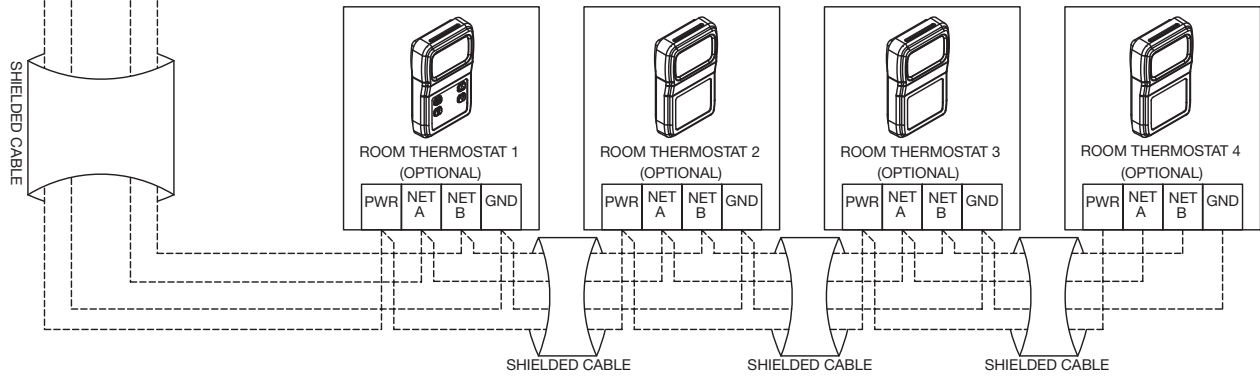

## Maintenance Log

Date \_\_\_\_\_ Time \_\_\_\_\_ AM/PM

Notes: \_\_\_\_\_  
\_\_\_\_\_  
\_\_\_\_\_  
\_\_\_\_\_

Date \_\_\_\_\_ Time \_\_\_\_\_ AM/PM

Notes: \_\_\_\_\_  
\_\_\_\_\_  
\_\_\_\_\_  
\_\_\_\_\_

Date \_\_\_\_\_ Time \_\_\_\_\_ AM/PM

Notes: \_\_\_\_\_  
\_\_\_\_\_  
\_\_\_\_\_  
\_\_\_\_\_

Date \_\_\_\_\_ Time \_\_\_\_\_ AM/PM

Notes: \_\_\_\_\_  
\_\_\_\_\_  
\_\_\_\_\_  
\_\_\_\_\_

Date \_\_\_\_\_ Time \_\_\_\_\_ AM/PM

Notes: \_\_\_\_\_  
\_\_\_\_\_  
\_\_\_\_\_  
\_\_\_\_\_

Date \_\_\_\_\_ Time \_\_\_\_\_ AM/PM

Notes: \_\_\_\_\_  
\_\_\_\_\_  
\_\_\_\_\_  
\_\_\_\_\_

Date \_\_\_\_\_ Time \_\_\_\_\_ AM/PM

Notes: \_\_\_\_\_  
\_\_\_\_\_  
\_\_\_\_\_  
\_\_\_\_\_

Date \_\_\_\_\_ Time \_\_\_\_\_ AM/PM

Notes: \_\_\_\_\_  
\_\_\_\_\_  
\_\_\_\_\_  
\_\_\_\_\_

## Our Commitment

*As a result of our commitment to continuous improvement, Greenheck reserves the right to change specifications without notice.*

Specific Greenheck product warranties are located on [greenheck.com](http://greenheck.com) within the product area tabs and in the Library under Warranties.

AMCA Publication 410-96, Safety Practices for Users and Installers of Industrial and Commercial Fans, provides additional safety information. This publication can be obtained from AMCA International, Inc. at [www.amca.org](http://www.amca.org).

