

Miami-Dade Qualified Sightproof Louver

Application and Design

ESS-502D is a **Florida Product Approved and Miami-Dade Qualified** stationary sightproof blade extruded aluminum louver designed to protect air intake and exhaust openings in building exterior walls. ESS-502D is tested in accordance with AMCA 500-L Air Performance and Water Penetration. ESS-502D is tested in accordance with AMCA 540 Test Method for Louvers Impacted by Wind Borne Debris (Basic Protection, Missile Level D and Enhanced Protection, Missile Level E). **ESS-502D is licensed to bear the AMCA seal allowing design professionals to select and apply with confidence.** ESS-502D is tested and qualified per the following Florida test protocols: TAS 201 (Large Missile Impact), TAS 202 (Uniform Static Air Pressure) and TAS 203 (Cyclic Wind Loading). Per Miami-Dade ESS-502D may be installed in locations where the space behind the louver is designed to accept water penetration and houses water resistant/water proof equipment, components or supplies.

Standard Construction

Frame Heavy gauge extruded 6005-T5 (head, sill) and 6105-T5 (jamb) aluminum, 5 in. x 0.081 in. nominal wall thickness

Blades Chevron style, heavy gauge 6005-T5 extruded aluminum, 0.081 in. nominal wall thickness, positioned on approximately 2 in. centers

Construction Welded and mechanically fastened

Birdscreen 3/4 in. x 0.051 flattened expanded aluminum in removable frame, inside mount (rear)

Finish Mill

Continuous Perimeter

Angles Ship loose, heavy gauge extruded aluminum, mill finish

Minimum Rough

Opening Size . . . 8 in. W x 7 in. H

Maximum Single Section Rough

Opening Size . . . 144.5 in. W or 144.5 in. H (limited to 72 sq. ft.)

Options (at additional cost)

- A variety of bird and insect screens
- Blank-off panels
- Extended sill
- Filter racks
- Flanged frame
- A variety of architectural finishes including:
 - Clear anodize
 - Integral color anodize
 - Baked enamel
 - Kynar

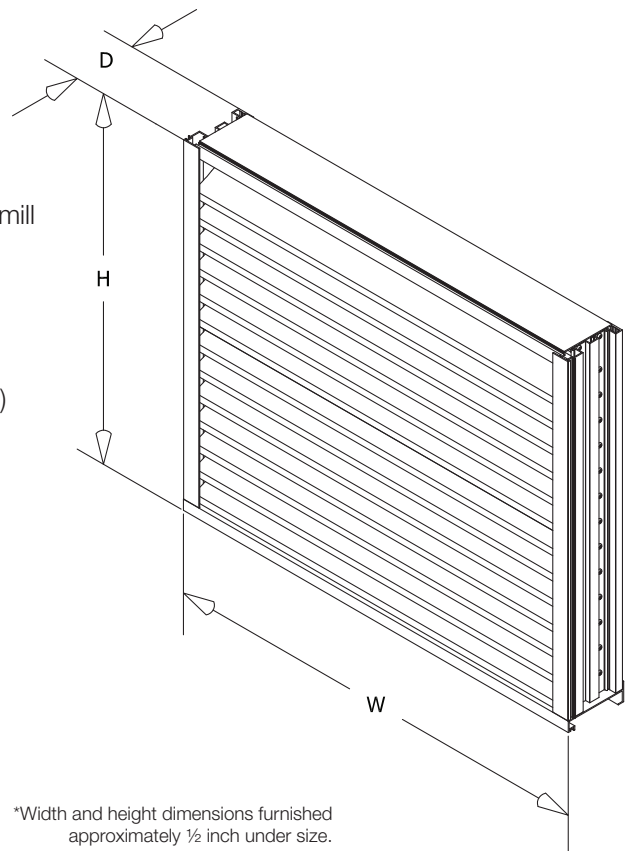
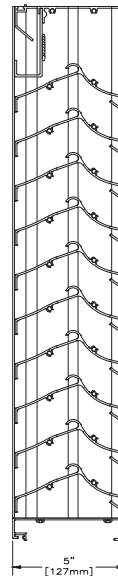

*Width and height dimensions furnished approximately 1/2 inch under size.

This label does not signify AMCA airflow performance certification.

PERFORMANCE DATA

ESS-502D

Florida Product Approval No: FL12941.1
 Miami-Dade NOA No.: 21-0526.09, EXP. 8/5/2024
 TDI Approval No.: LVR-06
 Maximum Wind-load: 110 PSF

Free Area Chart

Louver Height Inches	Louver Width in Inches											
	12	24	36	48	60	72	84	96	108	120	132	144
12	0.26	0.62	0.97	1.32	1.67	1.98	2.33	2.69	3.04	3.39	3.70	4.05
24	0.72	1.68	2.65	3.61	4.57	5.42	6.38	7.34	8.30	9.27	10.11	11.07
36	1.18	2.75	4.33	5.90	7.47	8.85	10.42	12.00	13.57	15.14	16.52	18.09
48	1.64	3.82	6.01	8.19	10.37	12.29	14.47	16.65	18.84	21.02	22.93	25.12
60	2.10	4.89	7.69	10.48	13.27	15.72	18.51	21.31	24.10	26.90	29.34	32.14
72	2.55	5.96	9.36	12.77	16.17	19.15	22.56	25.97	29.37	32.78	35.76	39.16
84	3.01	7.03	11.04	15.06	19.08	22.59						
96	3.47	8.10	12.72	17.35	21.98	26.02						
108	3.93	9.16	14.40	19.64	24.88	29.46						
120	4.39	10.23	16.08	21.93	27.78	32.89						
132	4.84	11.30	17.76	24.22	30.68	36.33						
144	5.30	12.37	19.44	26.51	33.58	39.76						

*Based on actual sizing



Greenheck Fan Corporation certifies that the ESS-502D louvers shown herein are licensed to bear the AMCA Seal. The ratings shown are based on tests and procedures performed in accordance with AMCA Publication 511 and comply with the requirements of the AMCA Certified Ratings Program. The AMCA Certified Ratings Seal applies to air performance and water penetration ratings.



IMPACT RESISTANT LOUVER
Enhanced Protection Level E

See www.AMCA.org for all certified or listed products

This label does not signify AMCA airflow performance certification.

Greenheck Fan Corporation certifies that the ESS-502D louvers shown herein are approved to bear the AMCA Listing Label. The Ratings shown are based on tests and procedures performance in accordance with AMCA Publications and comply with the requirements of the AMCA Listing Label Program. The AMCA Listing Label applies to Wind Borne Debris Impact Resistant Louvers.

Airflow Resistance (Standard Air - .075 lb/ft³)

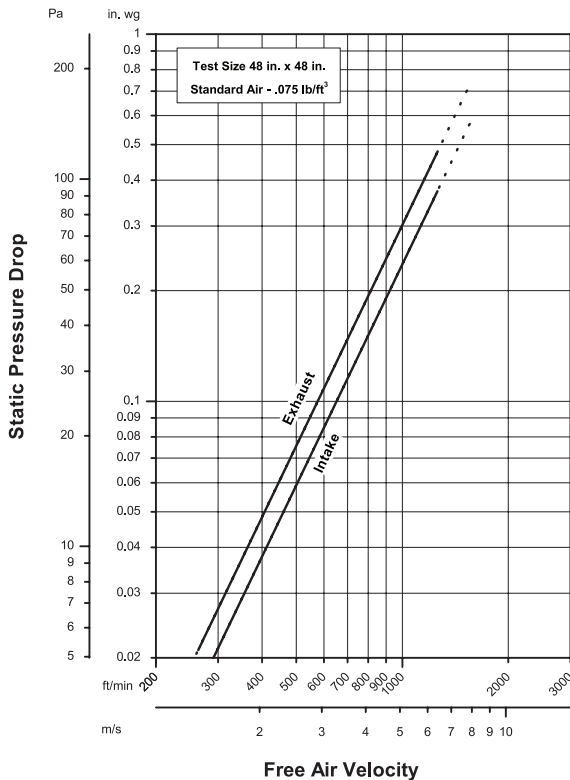

Model ESS-502D resistance to airflow (pressure drop) varies depending on louver application (air intake or air exhaust). Free area velocities (shown) are higher than average velocity through the overall louver size. See louver selection information. (Test Figure 5.5-6.5)

Water Penetration (Standard Air - .075 lb./ft.3)

Test size 48 in. x 48 in. Test duration of 15 min.

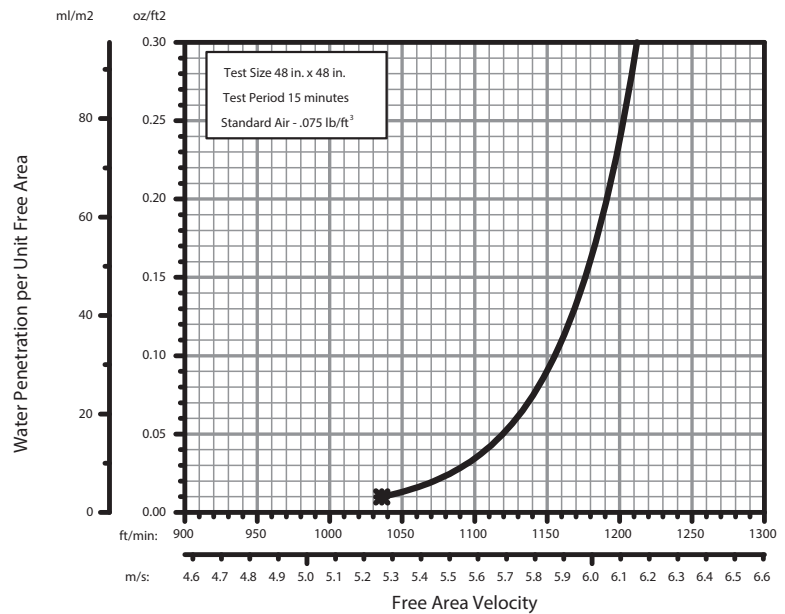

The AMCA Water Penetration Test provides a method for comparing various louver models and designs as to their efficiency in resisting the penetration of rainfall under specific laboratory test conditions. The beginning point of water penetration is defined as that velocity where the water penetration curve projects through .01 oz. of water (penetration) per sq. ft. of louver free area. ***The beginning point of water penetration for Model ESS-502D is 1036 fpm free area velocity.** These performance ratings do not guarantee a louver to be weatherproof or stormproof and should be used in combination with other factors including good engineering judgement in selecting louvers.



PRODUCT/INSTALLATION DETAILS

ESS-502D

SINGLE SECTION

Florida Product Approval No: FL12941.1
 Miami-Dade NOA No.: 21-0526.09, EXP. 8/5/2024
 TDI Approval No.: LVR-06
 Maximum Wind-load: 110 PSF

Model ESS-502D is a Miami-Dade Qualified louver and must be installed in accordance with the installation instructions shown herein. Model ESS-502D is qualified for installation within concrete/masonry, structural steel, steel stud or wood framed building conditions. Model ESS-502D is structurally calculated to withstand positive and negative wind-loads up to 110 PSF. The maximum single section rough opening width is 144.5 in. The maximum single section rough opening height is 144.5 in. In accordance with installation instructions, the maximum opening width can be unlimited if there is only one section high and the maximum opening height can be unlimited if there is only one section wide. Structural reinforcing members along with any associated installation hardware is not provided by Greenheck unless indicated otherwise by Greenheck. Options and are not subject to structural analysis unless indicated otherwise by Greenheck.

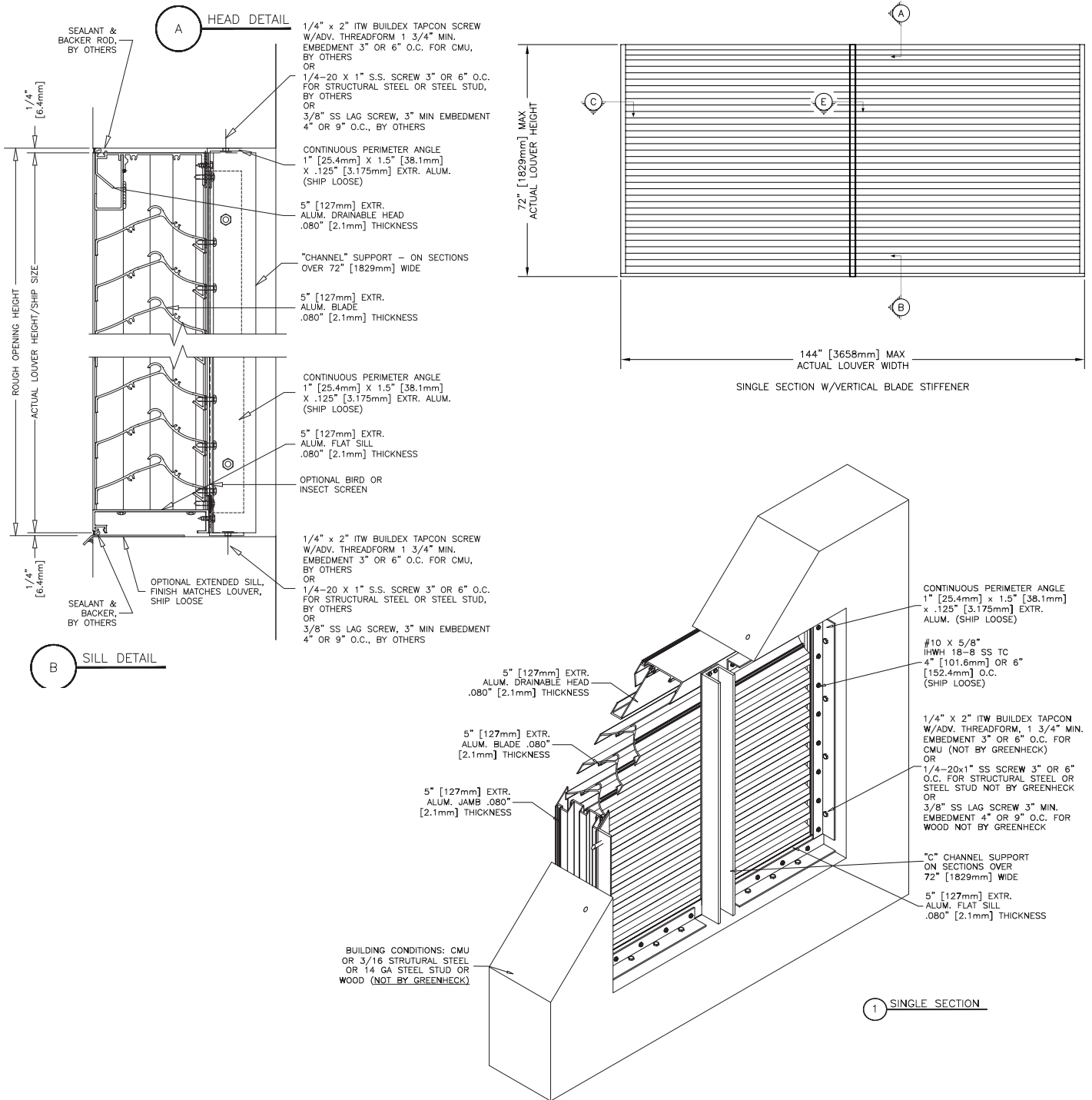

PRODUCT/INSTALLATION DETAILS

ESS-502D

MULTI-SECTION HIGH

Florida Product Approval No: FL12941.1
 Miami-Dade NOA No.: 21-0526.09, EXP. 8/5/2024
 TDI Approval No.: LVR-06
 Maximum Wind-load: 110 PSF

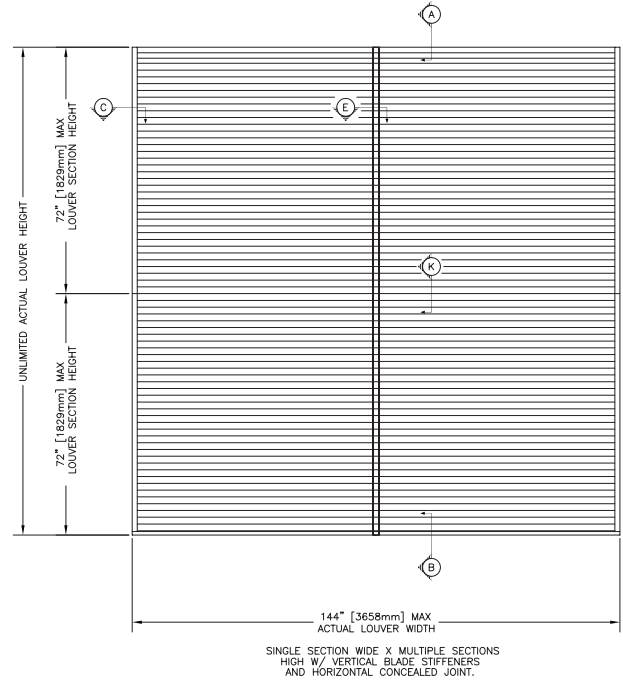
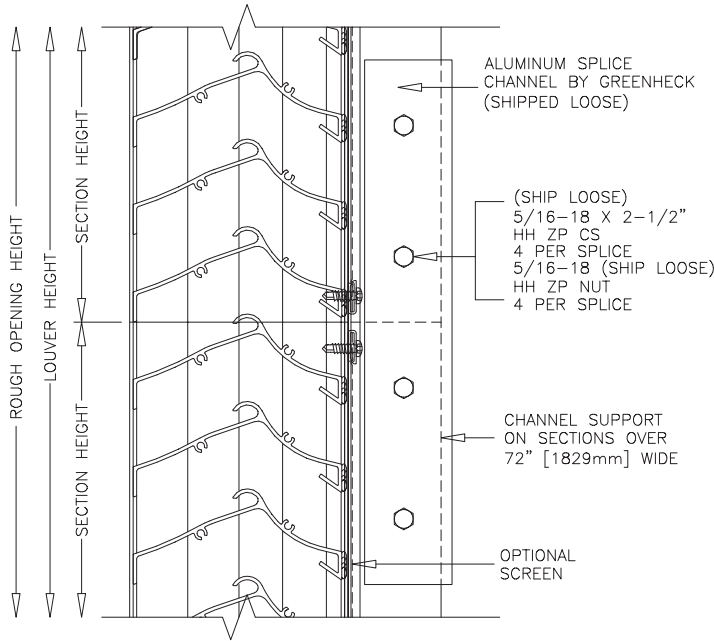

K CONCEALED JOINT DETAIL
 MULTI SECTIONS HIGH
 SINGLE SECTION WIDE

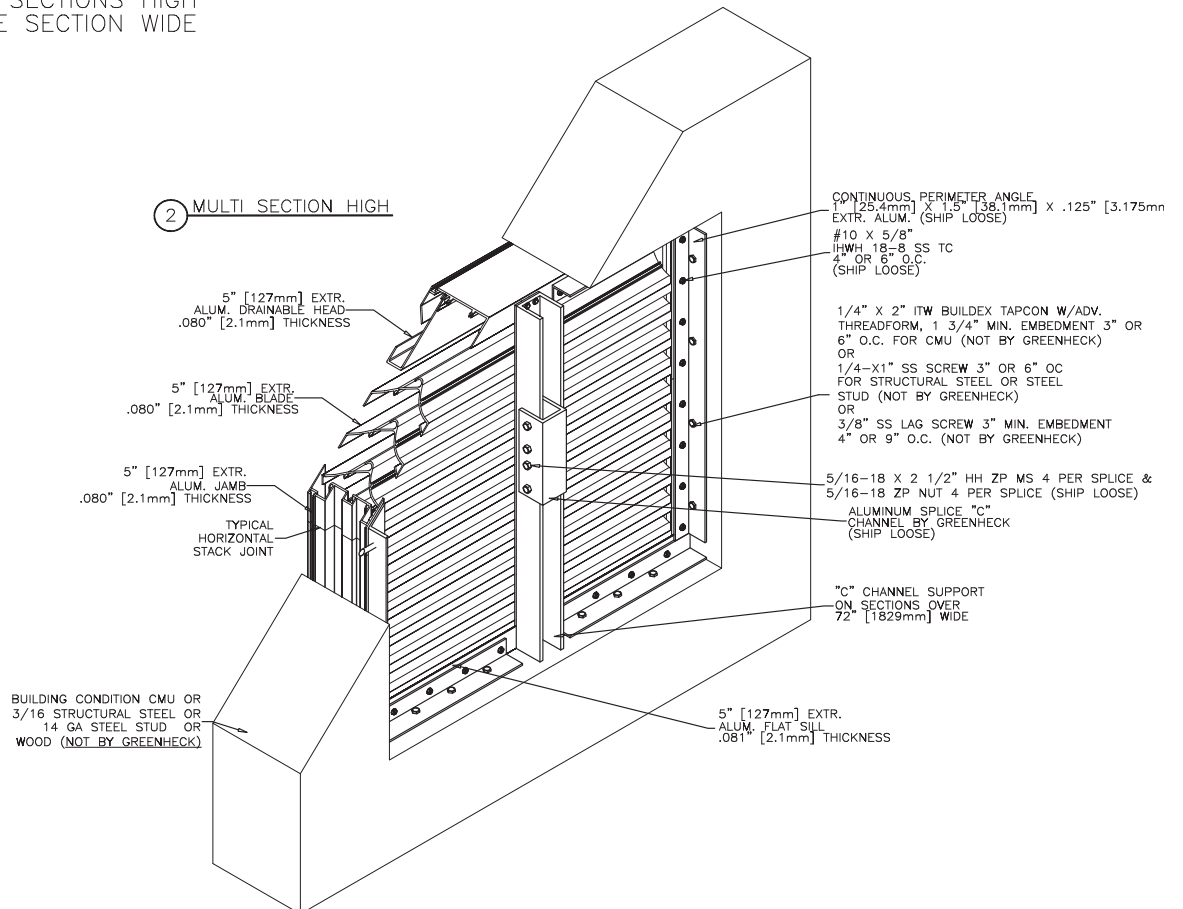

PRODUCT/INSTALLATION DETAILS

ESS-502D

Florida Product Approval No: FL12941.1
 Miami-Dade NOA No.: 21-0526.09, EXP. 8/5/2024
 TDI Approval No.: LVR-06
 Maximum Wind-load: 110 PSF

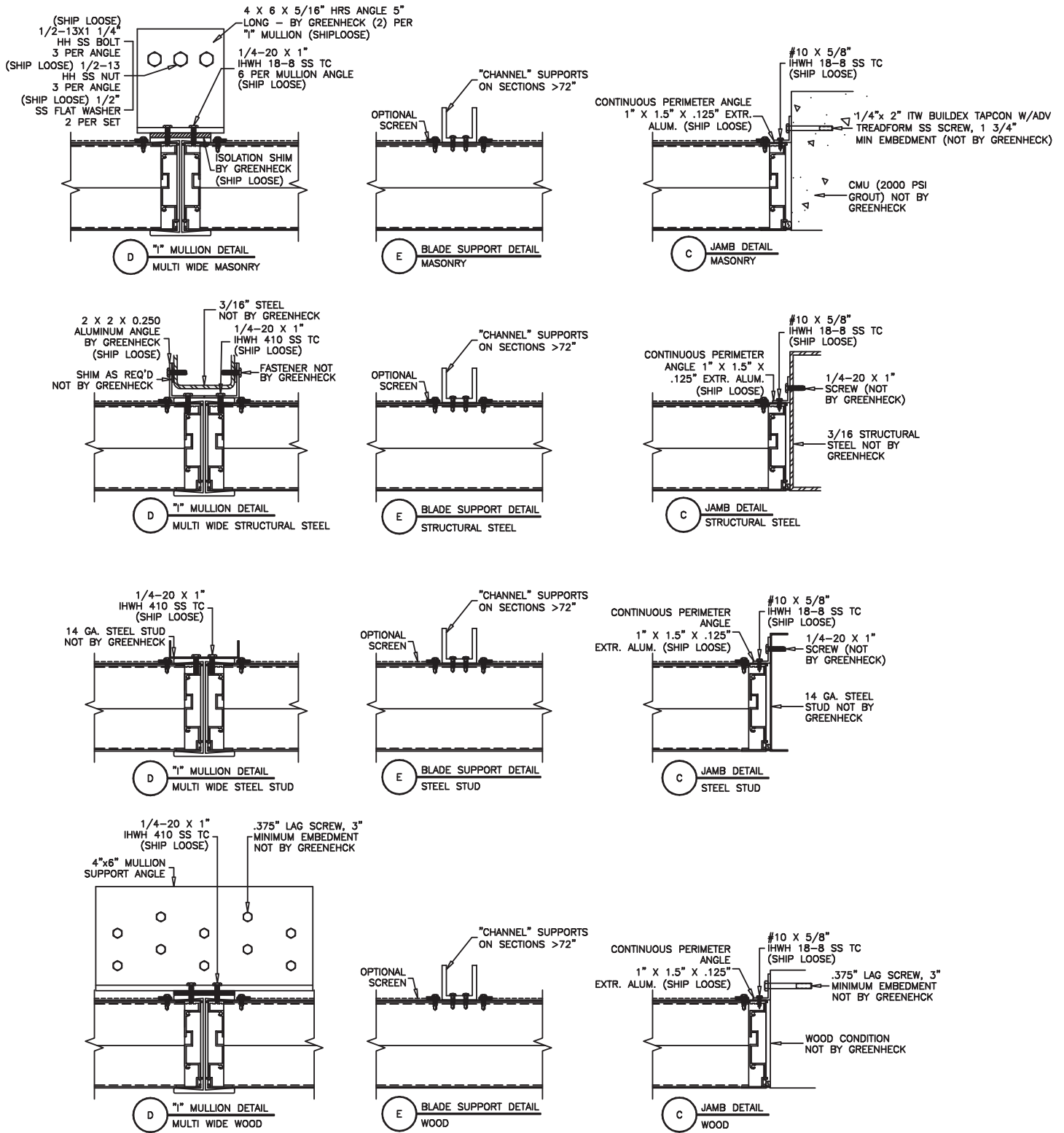

PRODUCT/INSTALLATION DETAILS

MULTI-SECTION WIDE CMU

ESS-502D

Florida Product Approval No: FL12941.1
 Miami-Dade NOA No.: 21-0526.09, EXP. 8/5/2024
 TDI Approval No.: LVR-06
 Maximum Wind-load: 110 PSF

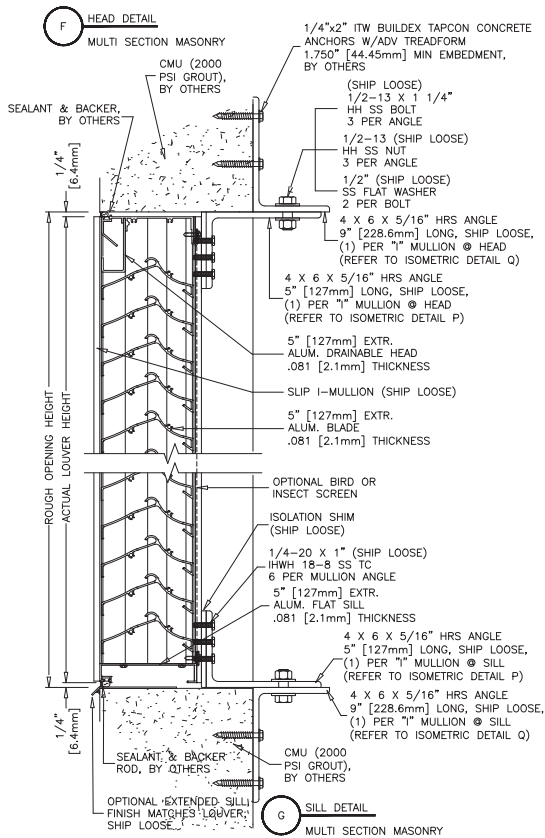

*CONTINUOUS 1.00 X 1.50 PERIMETER ANGLE NOT SHOWN FOR CLARITY- REF TO DETAIL 1

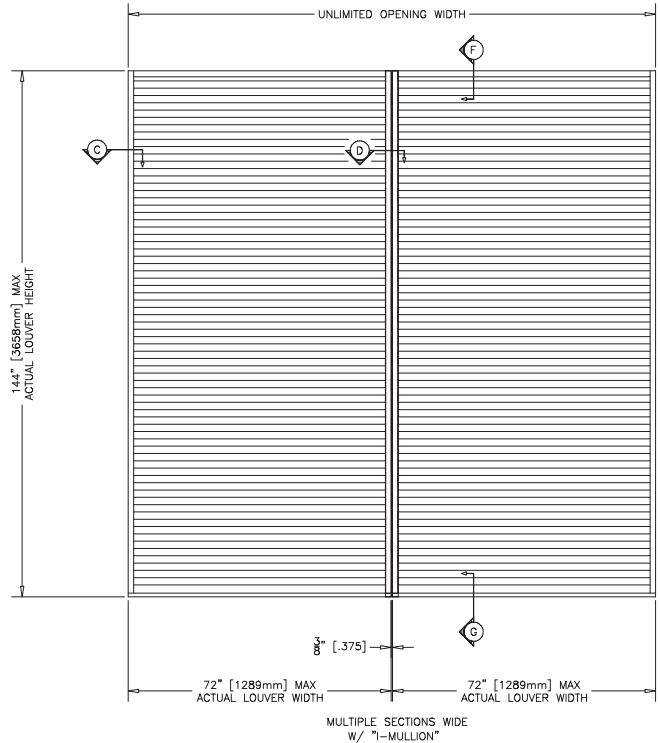

P ISOMETRIC ANGLE DETAIL
 MULTI WIDE MASONRY

"1" MULLION ANCHOR ANGLE
 4 x 6 x 5/16 HRS, 5" [127mm] LONG - PRIME PAINTED (SHIP LOOSE)

"1" MULLION ANCHOR ANGLE
 4 x 6 x 5/16 HRS, 9" [228.6mm] LONG - PRIME PAINTED (SHIP LOOSE)

9/16" HOLES (3) FIELD DRILLED, NOT BY GREENHECK

Q ISOMETRIC ANGLE DETAIL
 MULTI WIDE MASONRY

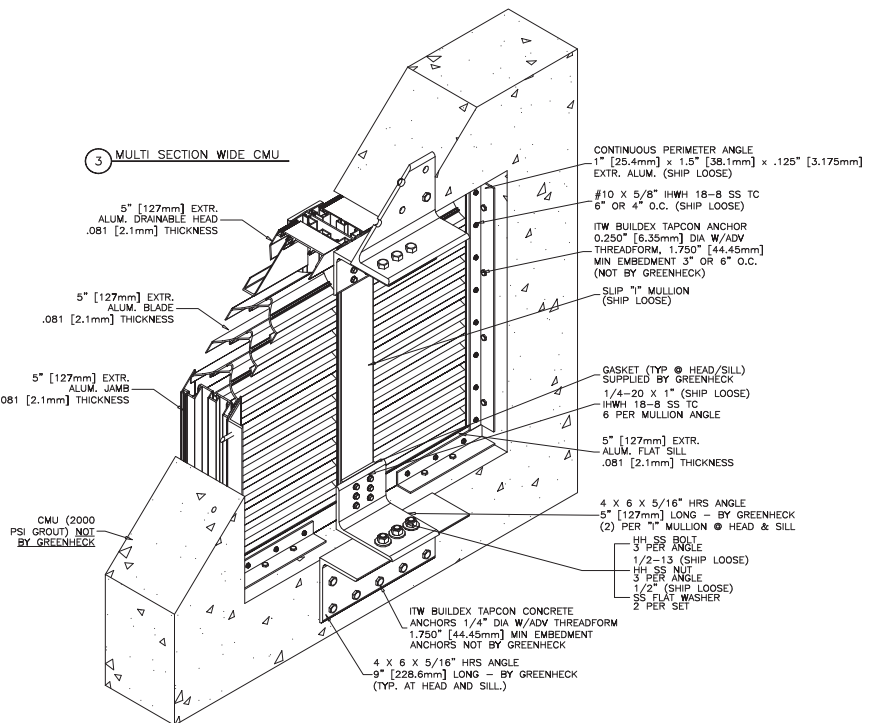

PRODUCT/INSTALLATION DETAILS

MULTI-SECTION WIDE STRUCTURAL STEEL

ESS-502D

Florida Product Approval No: FL12941.1
 Miami-Dade NOA No.: 21-0526.09, EXP. 8/5/2024
 TDI Approval No.: LVR-06
 Maximum Wind-load: 110 PSF

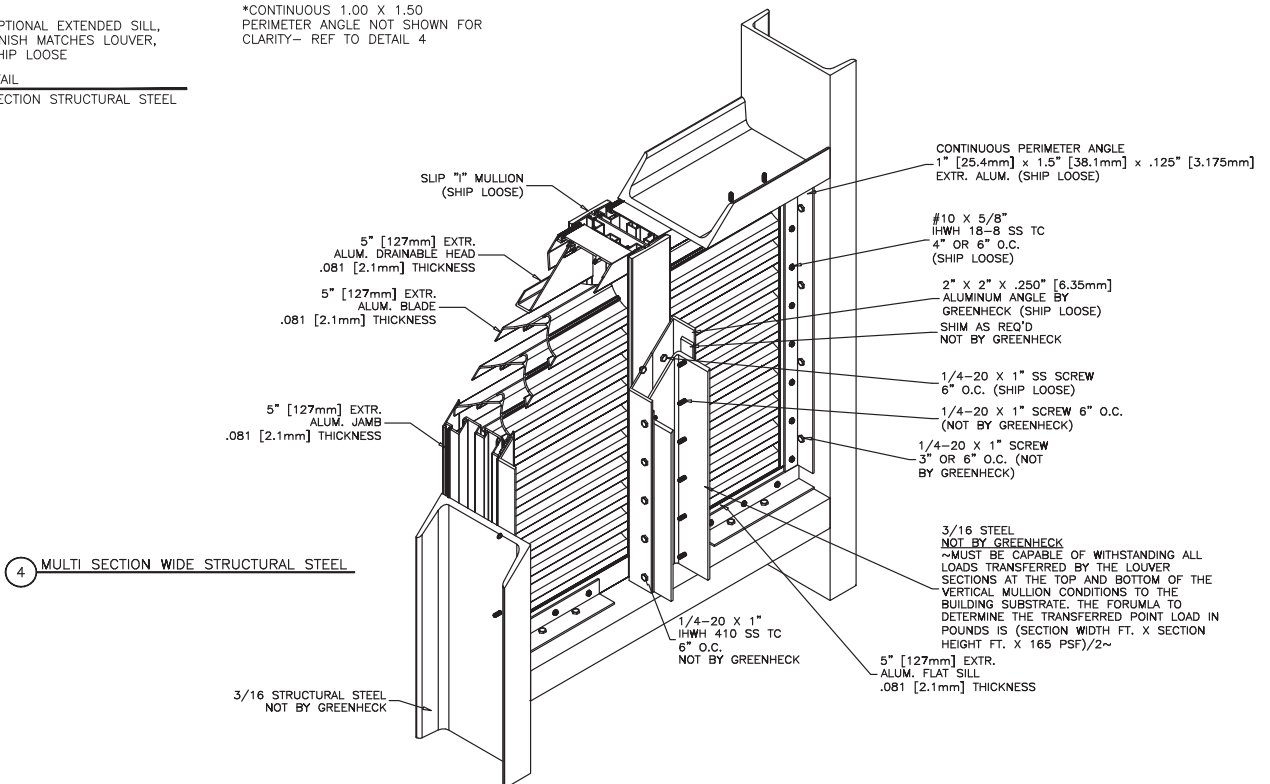
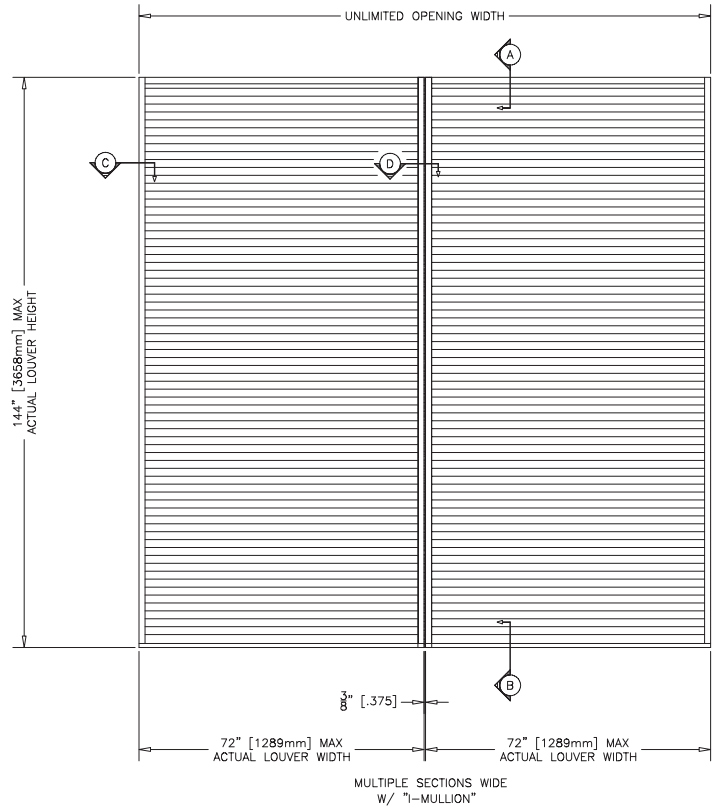
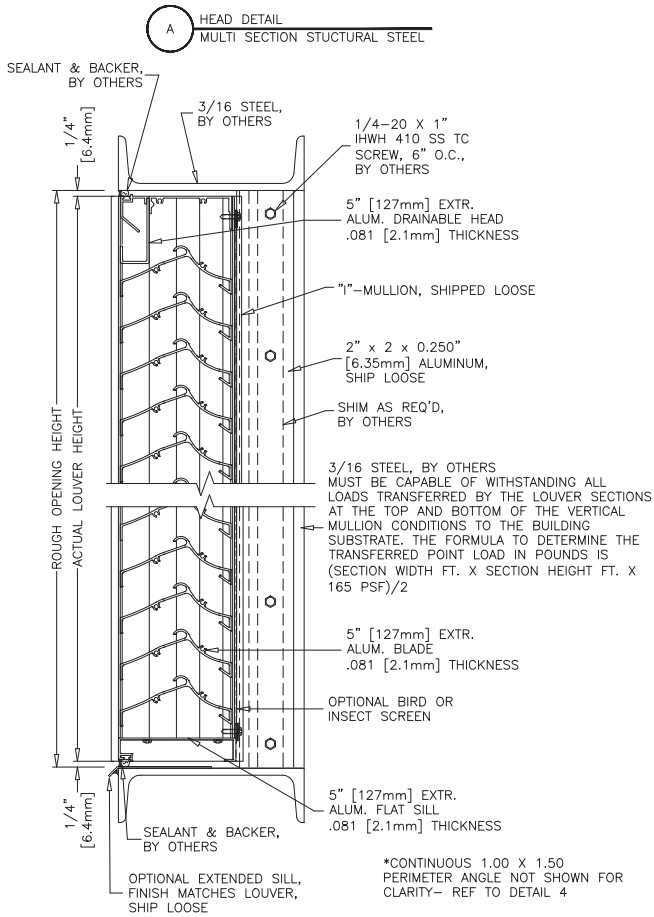

PRODUCT/INSTALLATION DETAILS

MULTI-SECTION WIDE STEEL STUD

ESS-502D

Florida Product Approval No: FL12941.1
 Miami-Dade NOA No.: 21-0526.09, EXP. 8/5/2024
 TDI Approval No.: LVR-06
 Maximum Wind-load: 110 PSF

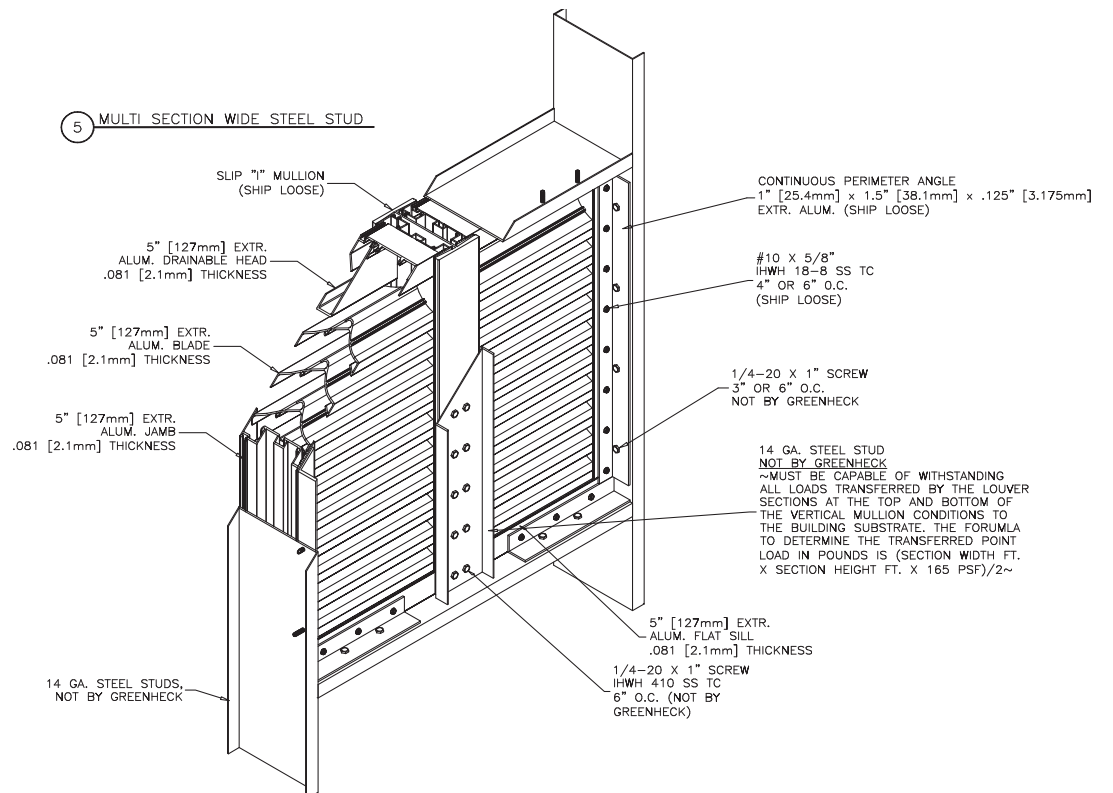
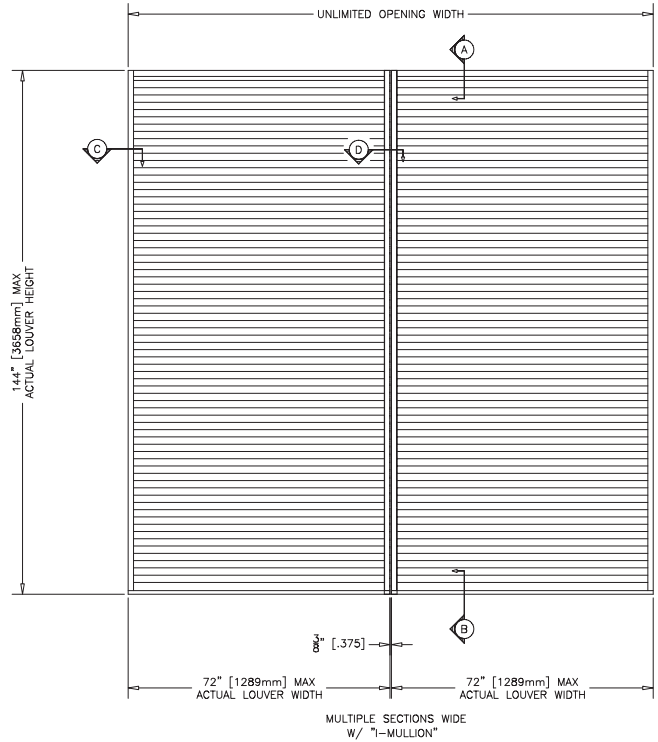
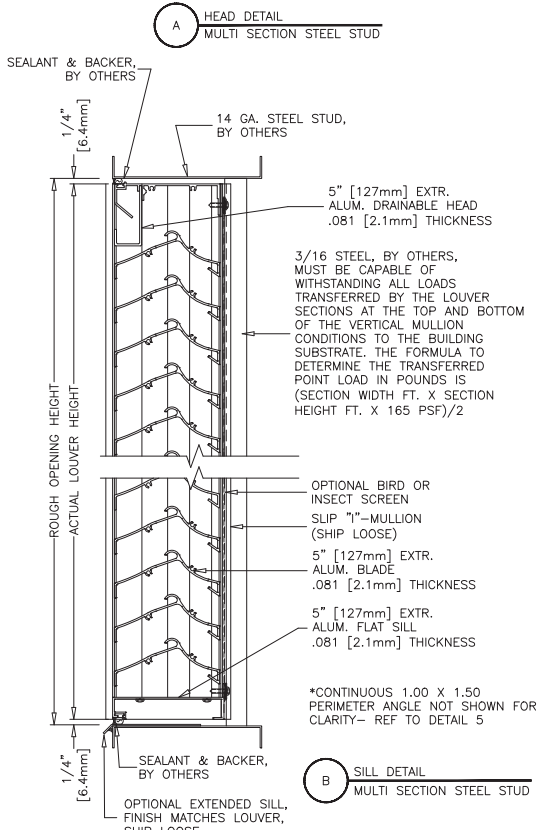

PRODUCT/INSTALLATION DETAILS

MULTI-SECTION WIDE WOOD

ESS-502D

Florida Product Approval No: FL12941.1
 Miami-Dade NOA No.: 21-0526.09, EXP. 8/5/2024
 TDI Approval No.: LVR-06
 Maximum Wind-load: 110 PSF

A HEAD DETAIL
 MULTI SECTION WOOD

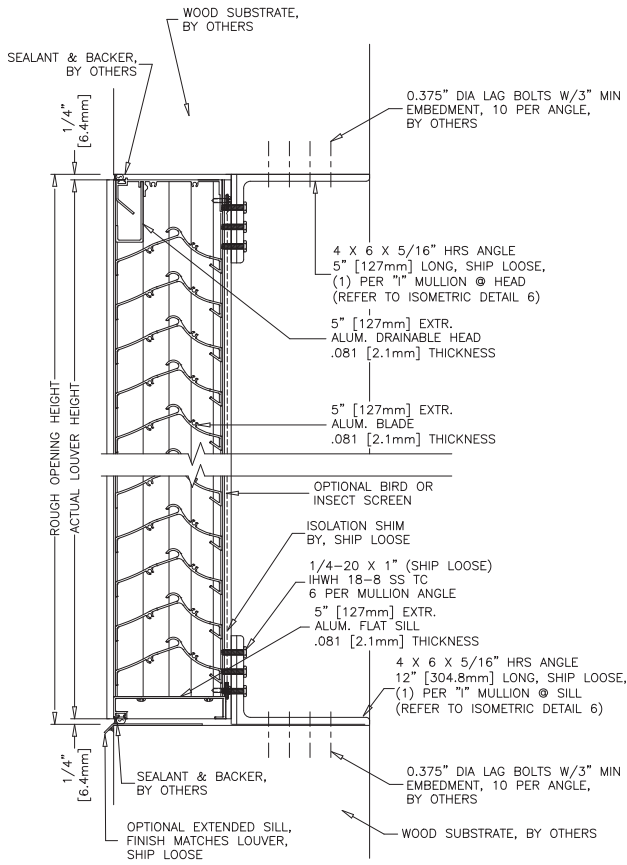

B SILL DETAIL
 MULTI SECTION WOOD

*CONTINUOUS 1.00 X 1.50 PERIMETER ANGLE NOT SHOWN FOR CLARITY- REF TO DETAIL 6

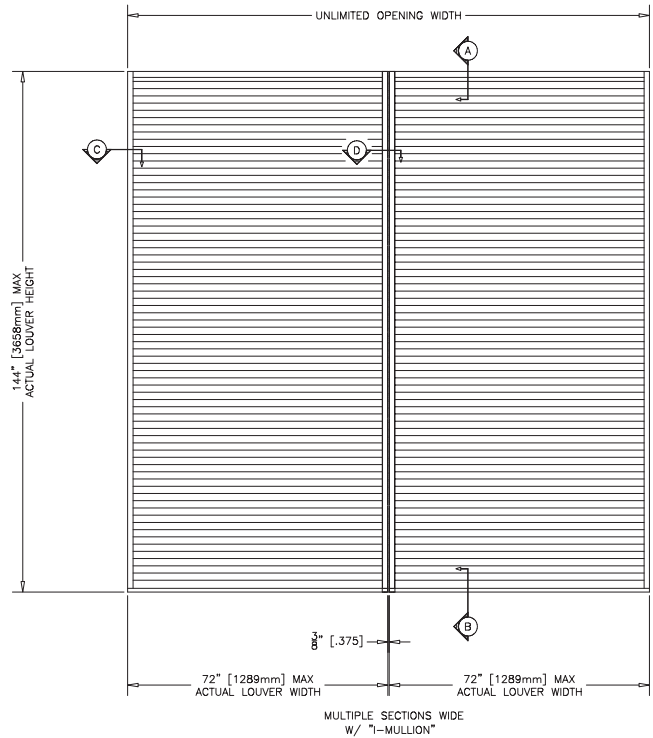

6 MULTI SECTION WIDE WOOD

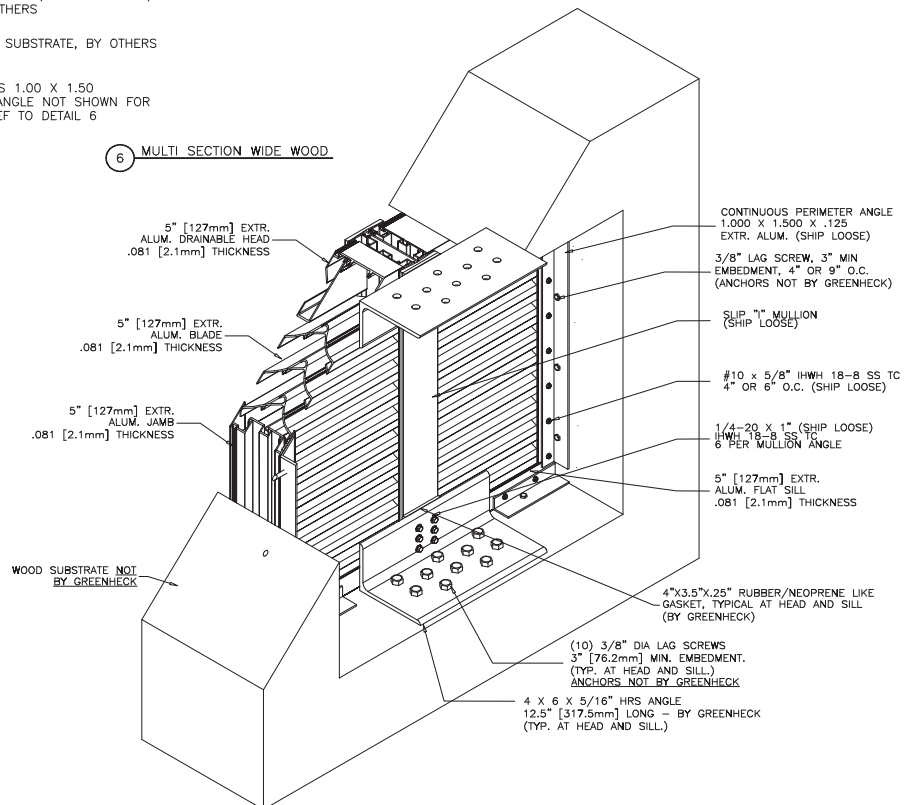

OPTION DRAWINGS

ESS-502D

Florida Product Approval No: FL12941.1
 Miami-Dade NOA No.: 21-0526.09, EXP. 8/5/2024
 TDI Approval No.: LVR-06
 Maximum Wind-load: 110 PSF

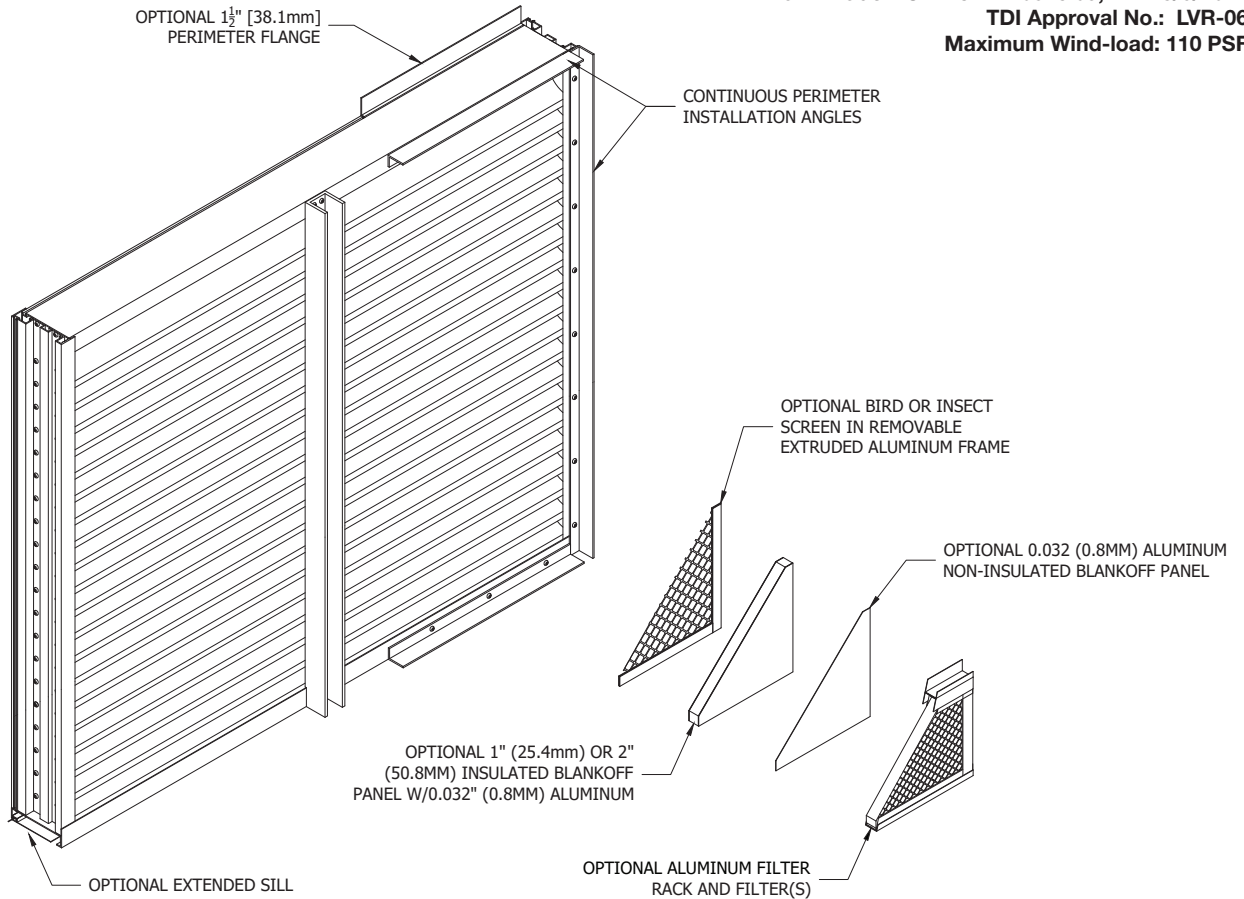

FINISHES

Finish Type	Description/Application	Color Selection	Standard Warranty (Aluminum)
AAMA 2605 100% Fluoropolymer (FEVE) 2-Coat 70% Kynar® (PVDF) 3-Coat 70% Kynar® (PVDF) 4-Coat 70% Kynar® (PVDF)	"Best." The premier finish for extruded aluminum. Tough, long-lasting coating has superior color retention and abrasive properties. Resists chalking, fading, chemical abrasion and weathering.	Standard Colors: Any of the 27 standard colors shown can be furnished in 70% or 50% Kynar®, 100% Fluoropolymer or Baked Enamel.	10 Years (20 Years Optional)
AAMA 2604 50% Kynar® / Acroflur®	"Better." Tough, long-lasting coating has excellent color retention and abrasive properties. Resists chalking, fading, chemical abrasion and weathering.	Mica Colors: Greenheck offers 6 standard Mica colors for 70% Kynar® or 100% Fluoropolymer.	5 Years
AAMA 2603 Baked Enamel	"Good." Provides good adhesion and resistance to weathering, corrosion and chemical stain.	Custom Colors: Custom color matching is available. Consult your Greenheck representative for cost and/or lead-time implications if a custom color is required.	1 Year
AA-M10C22A42 Integral Color Anodize	"Two-step" anodizing is produced by following the normal anodizing step with a second, colorfast process.	Light, Medium, Dark or Extra Dark Bronze; Champagne; Black	5 years
AA-M10C22A41 Clear Anodize 215 R-1	Clear, colorless and hard oxide aluminum coating that resists weathering and chemical attack.	Clear	5 years
AA-M10C22A31 Clear Anodize 204	Clear, colorless and hard oxide aluminum coating that resists weathering and chemical attack.	Clear	1 Year
Prime Coat	Louvers or architectural products shall be cleaned, pre-treated and receive a prime coat finish suitable for field painting. Greenheck does not recommend prime coat or field painting of materials.		n/a
Mill	Materials may be supplied in natural aluminum or galvanized steel finish when normal weathering is acceptable and there is no concern for color or color change.		n/a

Finishes meet or exceed AAMA 2605, AAMA 2604, and AAMA 2603 requirements. Please consult www.greenheck.com for complete information on standard and extended paint warranties. Paint finish warranties are not applicable to steel products.



ESS-502D
 September 2021

Copyright © 2021 Greenheck Fan Corporation

Greenheck Fan Corporation reserves the right to make product changes without notice.