

Application

Model HCD-130LE is a heavy duty flanged frame style industrial control damper with fabricated airfoil blades. It is designed to control airflow and provide shutoff in Vektor Lab Exhaust systems. This model is available with parallel or opposed blade action.

Ratings

Pressure*

Up to 8.5 in. wg (2.1 kPa) - differential pressure

Velocity*

Up to 4000 fpm (20.3 m/s)

Temperature*

-40 to 250°F (-40 to 121°C). Temperatures over 250°F (121°C) require special blade end clearance. For higher temperatures, consult factory.

Construction

| | Standard | Optional |
|-------------------------|--|----------------------------------|
| Frame Depth (C) | 8 in. (203mm) | - |
| Frame Material | Galvanized Steel | 304SS, 316SS |
| Frame Type | Flanged Channel | |
| Frame Thickness | 14 ga. (2mm) | 10 ga. (3.5mm) 12 ga. (2.7mm) |
| Flange Width (D) | 2 in. (51mm) | - |
| Blade Action | Parallel (Isolation) Opposed (Bypass) | - |
| Blade Material | Galvanized Steel | 304SS, 316SS |
| Blade Seals | Silicone | - |
| Blade Thickness | 20 ga. (1mm) Double Skin | - |
| Blade Type | Fabricated Airfoil | |
| Linkage | Plated Steel | 304SS, 316SS |
| Jamb Seals | 301SS | 316SS |
| Axle Diameter | ½ in. (12.7mm) | - |
| Axle Bearing | Stainless Steel Sleeve | - |
| Axle Material | 316SS | - |
| Axle Seals | None | - |
| Paint Finishes | None | Hi Pro Polyester |
| Mounting Holes | Standard | - |



Optional actuator shown.

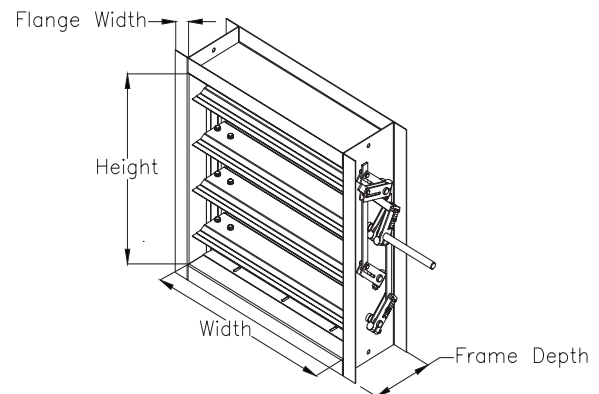

* Actual Inside Dimension. The W dimension is ALWAYS parallel with the damper blade length.
Damper linkage and axles may extend beyond the damper flange based on the configuration of selectable options. Consult factory for dimensions.

Size Limitations

| WxH | Minimum Size | Maximum Size |
|---------------|--------------|----------------|
| | | Single Section |
| Inches | 6½ x 5 | 57 x 57 |
| mm | 165 x 127 | 1448 x 1448 |

Features:

- Wide range of actuators available

Options:

- [Blade Seal Replacement](#)

Pressure Drop

This pressure drop data was conducted in accordance with AMCA Standard 500-D using the three configurations shown. All data has been corrected to represent standard air at a density of .075 lb/ft³ (1.2 kg/m³).

Actual pressure drop found in any HVAC system is a combination of many factors. This pressure drop information along with an analysis of other system influences should be used to estimate actual pressure losses for a damper installed in a given HVAC system.

AMCA Test Figures

Figure 5.3 illustrates a fully ducted damper. This configuration has the lowest pressure drop of the three test configurations because the entrance and exit losses are minimized by straight duct runs upstream and downstream of the damper.

Figure 5.2 illustrates a ducted damper exhausting air into an open area. This configuration has a lower pressure drop than Figure 5.5 because the entrance losses are minimized by a straight duct run upstream of the damper.

Figure 5.5 illustrates a plenum mounted damper. This configuration has the highest pressure drop because of the high entrance and exit losses due to the sudden changes of area in the system.

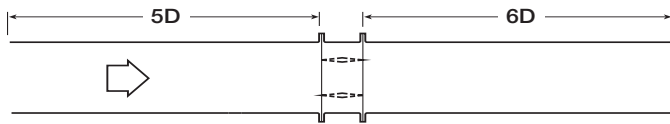

Fig. 5.3

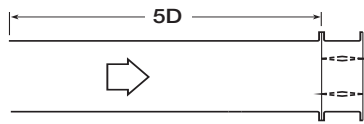

Fig. 5.2

$$D = \sqrt{\frac{4(W)(H)}{3.14}}$$

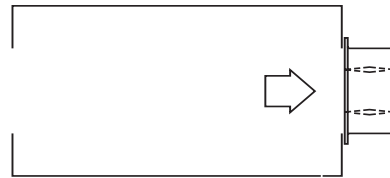
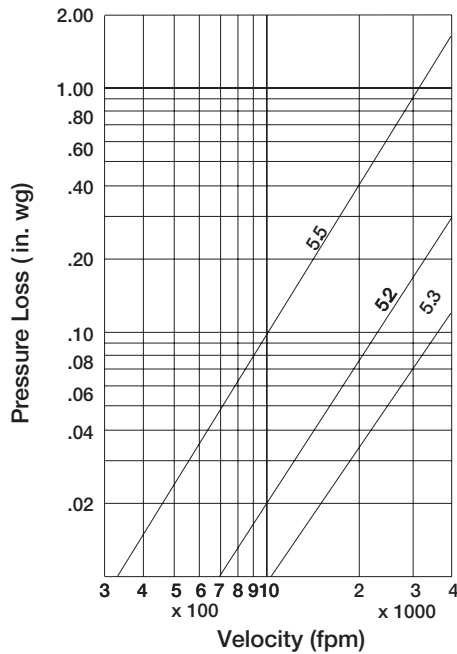

Fig. 5.5

Pressure Drop

36 x 36 in. Damper
(914mm x 914mm)



Leakage

Damper leakage (with blades fully closed) varies based on the type of low leakage seals applied. Model HCD-130LE is available with no jamb seals (standard) or with stainless steel jamb seals and EPDM, or silicone rubber blade seals. Leakage testing was conducted in accordance with AMCA Standard 500-D and is expressed as CFM per sq. ft. of damper face area. All data has been corrected to represent standard air at a density of .075 lb/ft³ (1.2 kg/m³).

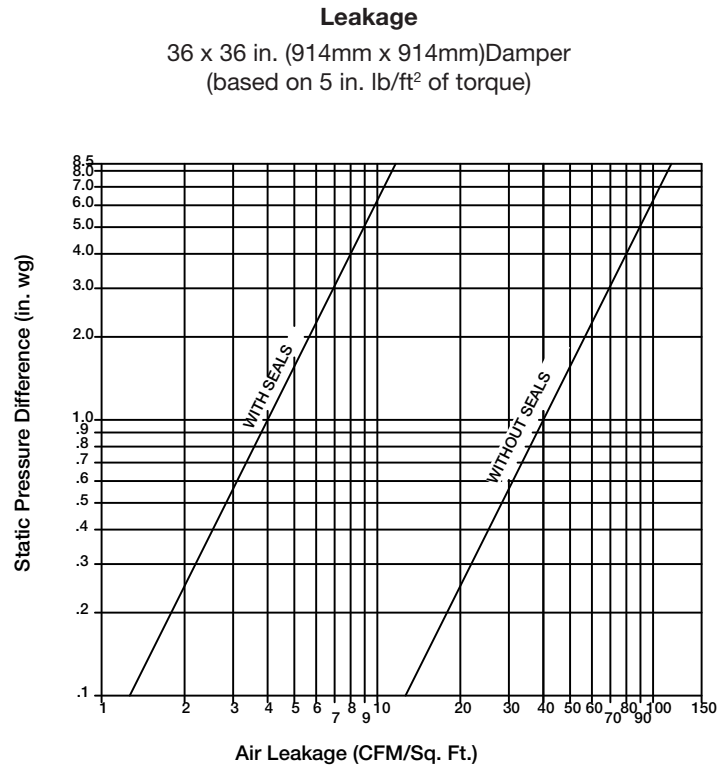

Limitations

Pressure Limitations

The chart at the right shows conservative pressure limitations based on a maximum blade deflection of w/360.

Temperature Limitations

Blade seals: Silicone -40° to 400°F (-40° to 204°C)

Jamb seals: Flexible stainless steel -40° to 400°F (-40° to 204°C)

For higher temperatures, consult factory.

Velocity Limitations

The chart at far right shows velocity limitations based on damper size.

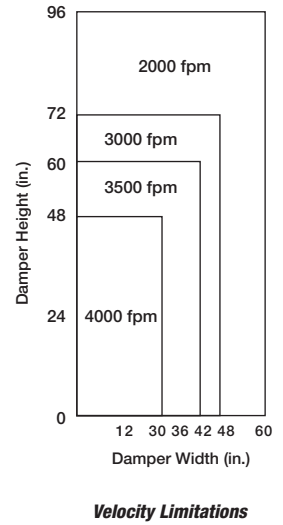
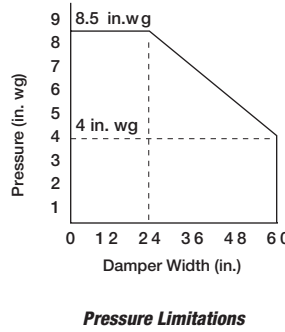

Document Links



[INSTALLATION](#)



[CATALOG](#)



[HD PRODUCT GUIDE](#)



[SPECIFICATIONS](#)



[SELECTION GUIDE](#)



[WARRANTY](#)

