

Application

Model HCD-230 is a heavy duty industrial control damper with a flanged frame. It is designed to control airflow and provide shut off in HVAC or industrial process control systems. A variety of optional features makes model HCD-230 extremely versatile, allowing its capabilities to be tailored to the application.

Damper Ratings

Velocity

Up to 5000 fpm (25.4 m/s)

Pressure

Up to 15 in. wg (3.7 kPa) - pressure differential

Temperature

-40°F to 600°F (-40°C to 315°C). Consult factory for temperatures.

Construction

	Standard	Optional
Frame Depth	8 in. (203 mm)	10 in. (254 mm)
Frame Material	Galvanized Steel	304SS, 316SS, Painted
Frame Material Thickness	14 ga. (2 mm)	10 ga. (3.5 mm) 12 ga. (2.7 mm)
Frame Type	Flanged channel	
Flange Width (D)	2 in. (51 mm)	1½ in. (64 mm) 2½ in. (64 mm) 3 in. (76 mm)
Blade Material	Galvanized Steel	304SS, 316SS, Painted
Blade Thickness	16 ga. (1.5 mm)	14 ga. (2 mm)
Blade Type	Fabricated Airfoil	
Blade Action	Parallel	Opposed
Blade Seals	None	EPDM, Silicone
Linkage	Plated steel	304SS, 316SS
Jamb Seals	None	316SS
Axle Diameter	¾ in. (19 mm)	
Axle Bearings	Stainless Steel Sleeve	External Bronze, External Ball, Outboard Bronze, Outboard Ball
Axle Material	Plated steel	303SS, 316SS
Axle Seals	None	O-ring, Double Gland
Paint Finishes	None	Hi Pro Polyester, Hi Temperature Flame Control, Hi Temperature Silver, Industrial Epoxy
Mounting Holes	None	Standard Standard with corner holes

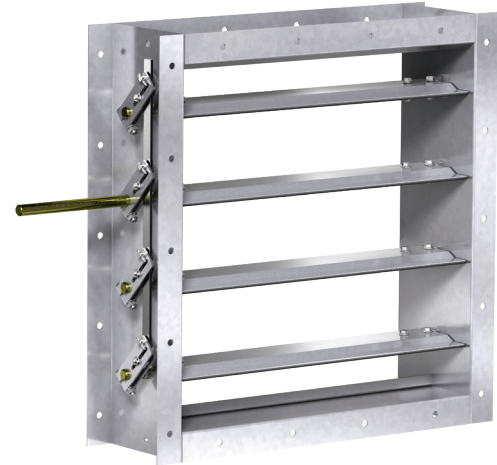

* Actual Inside Dimension. The W dimension is ALWAYS parallel with the damper blade length.

Damper linkage and axles may extend beyond the damper flange based on the configuration of selectable options. Consult factory for dimensions.

Size Limitations

W x H	Minimum Size	Maximum Size	
		Single Section	Multi - Section
Inches	6½ x 6	60 x 96	120 x 96
mm	165 x 152	1524 x 2438	3048 x 2438

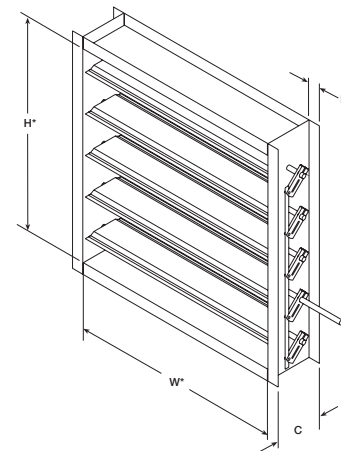

Options

- Wide range of actuators available
- Vertical blade orientation

Performance Data

Pressure Limitations

The chart at the right shows conservative pressure limitations based on a maximum blade deflection of $w/360$.

Temperature Limitations

- Blade seals:** Silicone -40° to 400°F (-40° to 204°C)
EPDM -20° to 250°F (-29° to 121°C)
- Jamb seals:** Flexible stainless steel -40° to 400°F (-40° to 204°C)

For higher temperatures, consult factory.

Velocity Limitations

The chart at far right shows velocity limitations based on damper size.

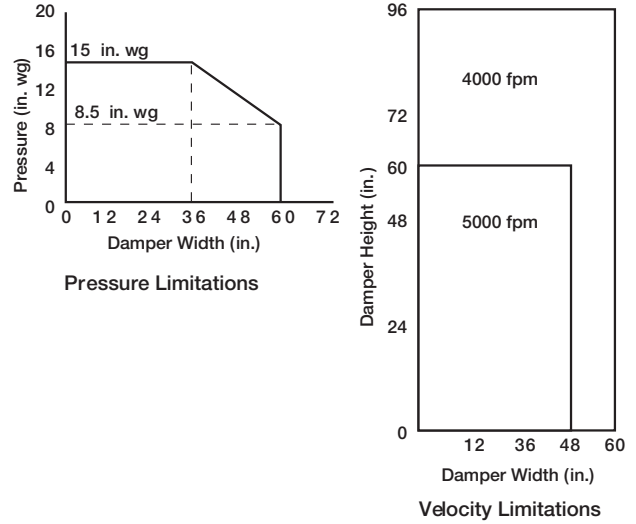

Pressure Drop Data

This pressure drop data was conducted in accordance with AMCA Standard 500-D using the three configurations shown. All data has been corrected to represent standard air at a density of .075 lb/ft³ (1.2 kg/m³).

Actual pressure drop found in any HVAC system is a combination of many factors. This pressure drop information along with an analysis of other system influences should be used to estimate actual pressure losses for a damper installed in a given HVAC system.

AMCA Test Figures

Figure 5.3 illustrates a fully ducted damper. This configuration has the lowest pressure drop of the three test configurations because the entrance and exit losses are minimized by straight duct runs upstream and downstream of the damper.

Figure 5.2 illustrates a ducted damper exhausting air into an open area. This configuration has a lower pressure drop than Figure 5.5 because the entrance losses are minimized by a straight duct run upstream of the damper.

Figure 5.5 illustrates a plenum mounted damper. This configuration has the highest pressure drop because of the high entrance and exit losses due to the sudden changes of area in the system.

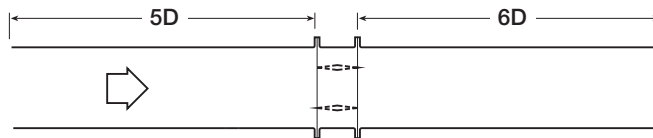

Fig. 5.3

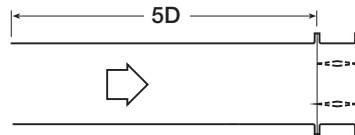

Fig. 5.2

$$D = \sqrt{\frac{4(W)(H)}{3.14}}$$

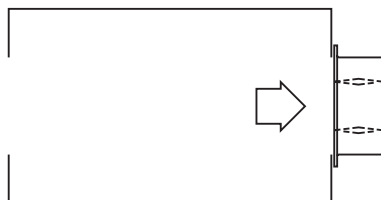
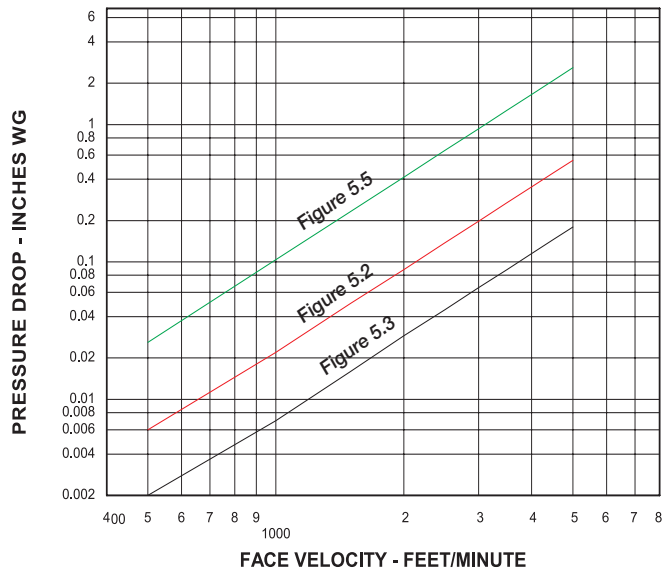

Fig. 5.5

Performance Data

Pressure Drop 36 x 36 in. Damper (914mm x 914mm)



Leakage Data

Damper leakage (with blades fully closed) varies based on the type of low leakage seals applied. Model HCD-230 is available with no jamb seals (standard) or with stainless steel jamb seals and EPDM, or silicone rubber blade seals. Leakage testing was conducted in accordance with AMCA Standard 500-D and is expressed as CFM per sq. ft. of damper face area. All data has been corrected to represent standard air at a density of .075 lb/ft³ (1.2 kg/m³).

Leakage 36 x 36 in. (914mm x 914mm) Damper (based on 5 in. lb/ft² of torque)

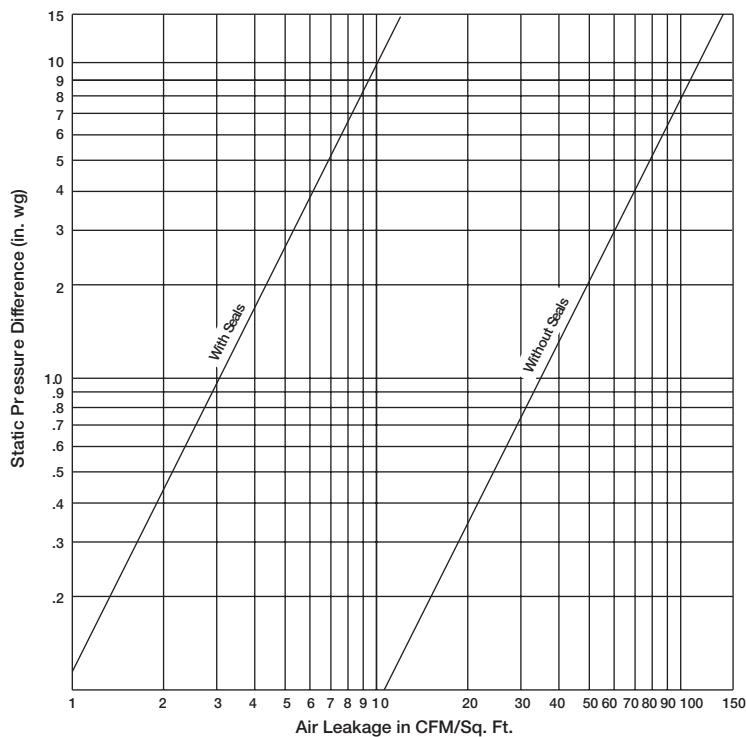

Bolt holes are available as an option. The standard pattern is $\frac{7}{16}$ in. (11mm) diameter holes (M dimension) spaced 6 in. (152mm) on center (L dimension). Custom bolt hole patterns are available. Contact factory for the limitations.

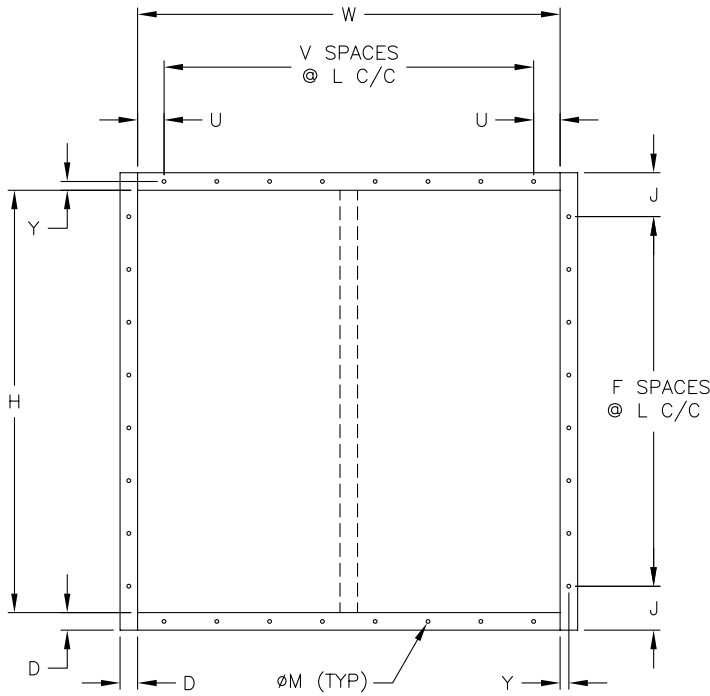

Standard Mounting Hole Pattern
Typical for single or double wide panel

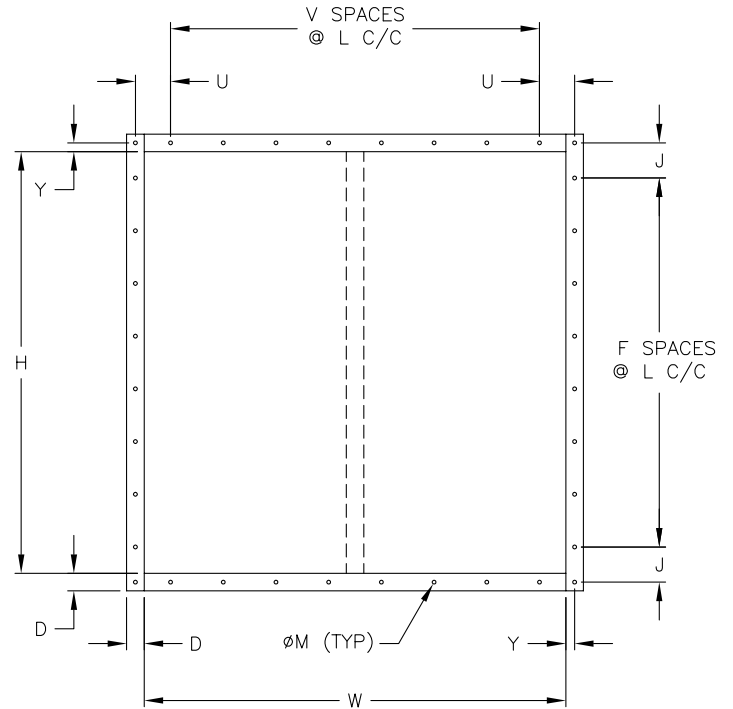

Standard Mounting Hole Pattern with Corner Holes
Typical for single or double wide panel

Links

[Installation Instructions](#)



[Heavy Duty and Industrial Damper Catalog](#)



[Heavy Duty and Industrial Damper Selection Guide](#)



[All Damper Product Selection Guide](#)



[Damper Warranty Statement](#)



[Specifications](#)

