

Application

The WD-300 series dampers are designed to prevent reverse airflow in horizontal exhaust applications. The WD-300 features a pressure sensitive blade design that opens and remains open under low velocity conditions. The dampers are opened by air pressure differential and closed by gravity. Optional motor pack converts the damper to motorized operation.

Ratings

Pressure

2.0 in. wg (0.5 kPa) - differential pressure

Velocity

2500 fpm (13 m/s)

Temperature

180°F (82°C)



*W & H dimensions furnished approximately 1/8 in. (3mm) undersize.

Construction

	Standard
Frame Material	Galvanized steel
Frame Thickness	18 ga. (1.3mm)
Frame Type	No flange (WD-330)
	Flange on intake (WD-300)
	Flange on discharge (WD-320)
Blade Material	Roll formed aluminum
Blade Thickness	0.025 in. (0.64mm) - 0.032 in. (0.8mm) for triple panel
Blade Seals	Vinyl
Axle	3/16 in. (4.8mm) dia. zinc plated steel pin on blade ends
Axle Bearings	Synthetic
Linkage Material	Galvanized Steel

Frame Styles

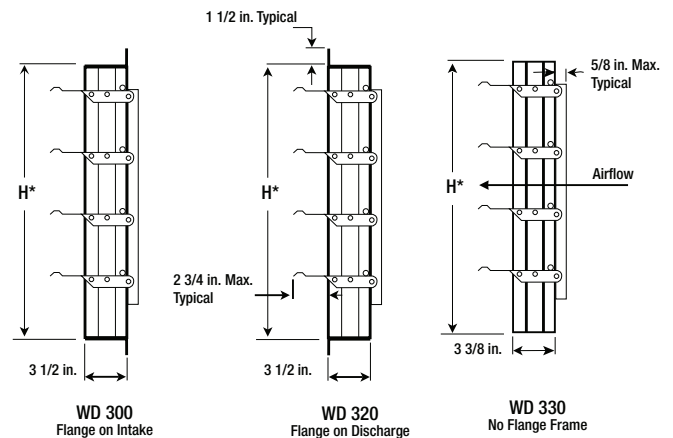

Size Limitations

W x H	Minimum Size	Maximum Size	
		Single Panel	Multiple Panels
WD-300 & WD-320			
Inches	6 x 6	31 x 74	148 x 148
mm	152 x 152	787 x 1880	3759 x 3759
WD-330			
Inches	6 x 6	31 x 74	150 x 148
mm	152 x 152	787 x 1880	3810 x 3759

Options

- End switch kit (part no. 851038)
- Motor packs (24V, 120V, 208-240V, 440V)

Performance Data

Pressure Drop

Performance data results from testing a 36 in. x 36 in. (914mm x 914mm) damper in accordance with AMCA Standard 500-D using Figure 5.5 (unducted). All data has been corrected to represent standard air at 0.075 lb/ft³ (1.201 kg/m³).

Operational Data		ΔP in. wg (kPa)	Velocity fpm (m/s)
Blades start to open	Non-ducted	0.05 (.012)	300 (1.5)
Blades fully open	Non-ducted	0.15 (.037)	900 (4.5)

Pressure Drop
36 in. x 36 in. (914mm x 914mm) Damper

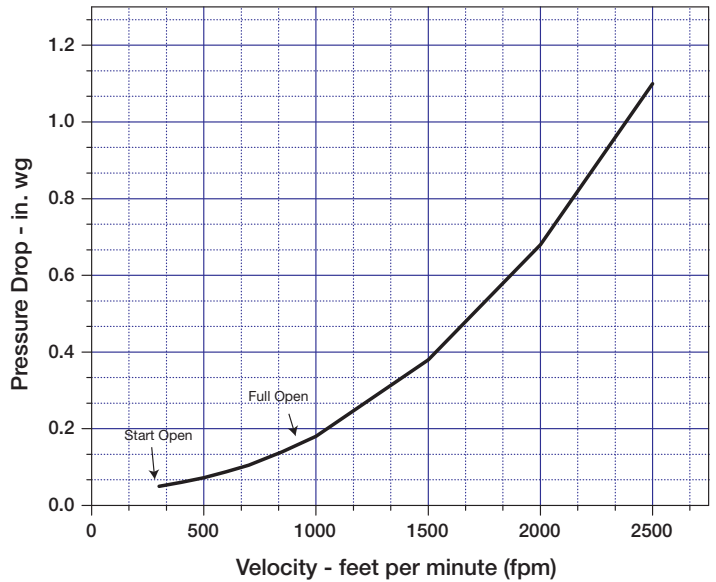

Leakage

Leakage testing was conducted in accordance with AMCA Standard 500-D and is expressed as CFM per sq. ft. of damper face area. All data has been corrected to represent standard air at 0.075 lb/ft³ (1.201 kg/m³).

Leakage
36 in. x 36 in. (914mm x 914mm) Damper

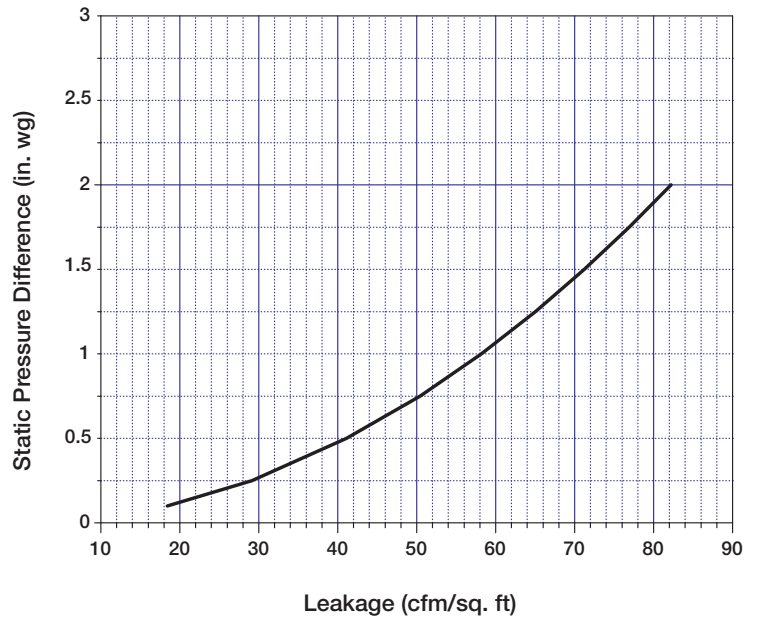

Motor Packs

Series MP-310 motor pack may be field installed to convert the WD-300 series backdraft damper to motorized operation. Airflow direction should remain horizontal exhaust when this motorized version is applied. These versatile motor packs feature power opening with spring return. The springs also provide damper closure in the event of electrical failure.

The MP-310 motor packs are available in voltages of 24, 120, 208, and 440. 575/600 volts may be used with any of the motor packs by way of a transformer (part no. 380711) and the appropriate 115 volt motor pack (MP-310). MP-310 series motor packs are UL listed. Please specify voltage when ordering.

There is one motor pack available on the WD-300 series damper to accommodate for larger torque requirements. To determine the number of motor packs required per WD-300 or WD-320 damper, refer to the table on page 5. To determine the number of motor packs required per WD-330 damper, refer to the table on page 7. Oversized applications may require several dampers connected together for one opening.

MP-300 series motor packs are supplied with mounting hardware, assembly instructions and actuator arms for either single, double, or triple panel installation.

MP-210/220A Motor packs	24V (50/60 Hz)	110V-120V (50/60Hz)	208V - 240V (50/60Hz)	440V (60Hz)
Stall Amps	.66	.15	.07	.041
Spec ID#	G24	G110-240	G110-240	G460



[MP-310 INSTALLATION](#)

Motor Pack Dimensional Data

WD-300 series dampers are available with an optional motor pack (MP-310). The diagram to the left illustrates the required clearance needed for proper operation of a mounted motor pack.

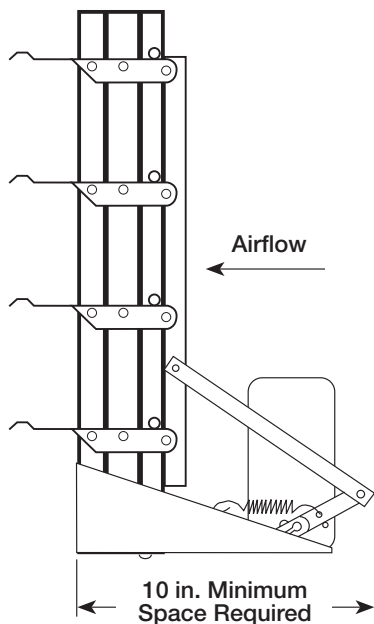











WD-300 series backdraft damper with optional motorpack

WD-300/320 Selection

Multiple section dampers shown below are supplied as equal size sections. Any damper that has multiple sections, both vertically and horizontally, will require field assembly and will require additional reinforcement (not supplied by Greenheck) to support the assembly. These larger dampers must have the additional reinforcement to give them structural stability.

The width dimension is always parallel to the length of the blades.

Note: The type and number of motor packs required can be found on page 5.

		Width					
		6	32	50	74	100	148
		6 Up To 32	32 Up To 50	50 Up Thru 74	Above 74 Up To 100	100 Up Thru 148	
Height	6 6 Up Thru 74	Single Panel One Section 	Double Panel One Section 	Triple Panel One Section 	Double Panel Two Section 	Double Panel Three Section 	
	74 Above 74 Thru 148	Single Panel Two Section 	Double Panel Two Section 	Triple Panel Two Section 	Double Panel Four Section 	Double Panel Six Section 	
148							

*Width and height given in inches.

Motor Pack Selection for WD-300/320

The table below will allow you to determine the type and number of motor packs needed for a given size WD-300/320 backdraft damper. For further information on a particular motor pack, refer to page 3.

		Width			
		6	50	100	148
Height	6	>=6 and <50 (1) MP-310 Motor Pack	>=50 and <100 (2) MP-310 Motor Packs	>=100 and <=148 (3) MP-310 Motor Packs	
	74	> 74 and <=148 (2) MP-310 Motor Packs	> 74 and <=148 (4) MP-310 Motor Packs	> 74 and <=148 (6) MP-310 Motor Packs	
		6	50	100	148
		>=6 and <=74	>=6 and <=74	>=6 and <=74	>=6 and <=74
		> 74 and <=148	> 74 and <=148	> 74 and <=148	> 74 and <=148
		6	50	100	148













*Width and height given in inches.

WD-330 Selection

Multiple section dampers shown below are supplied as equal size sections. Any damper that has multiple sections, both vertically and horizontally, will require field assembly and will require additional reinforcement (not supplied by Greenheck) to support the assembly. These larger dampers must have the additional reinforcement to give them structural stability.

The width dimension is always parallel to the length of the blades.

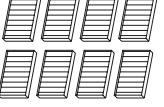
Note: The type and number of motor packs required can be found on page 7.

		Width						
		6	32	50	64	100	128	150
Height	6 Up Thru 74	6 Up To 32 Single Panel One Section 	32 Up Thru 50 Double Panel One Section 	Above 50 Up To 64 Single Panel Two Section 	64 Up Thru 100 Double Panel Two Section 	Above 100 Up To 128 Single Panel Four Section 	128 Up Thru 150 Double Panel Three Section 	
	Above 74 Thru 148	Single Panel Two Section 	Double Panel Two Section 	Single Panel Four Section 	Double Panel Four Section 	Single Panel Eight Section 	Double Panel Six Section 	

*Width and height given in inches.

Motor Pack Selection for WD-330

The table below will allow you to determine the type and number of motor packs needed for a given size WD-330 backdraft damper. For further information on a particular motor pack, refer to page 3.

		Width				
		6	50	100	128	150
Height	6	>=6 and <=50	>50 and <=100	>100 and <128	>=128 and <=150	
	>=6 and <=74	(1) MP-310 Motor Pack	(2) MP-310 Motor Packs	(4) MP-310 Motor Packs	(3) MP-310 Motor Packs	
	74	>74 and <=148				
	>74 and <=148	(2) MP-310 Motor Packs	(4) MP-310 Motor Packs	(8) MP-310 Motor Packs	(6) MP-310 Motor Packs	
	148					

*Width and height given in inches.

End Switch Kit (Optional)

An end switch is a control device used in conjunction with a motor pack (the end switch is usually wired to a fan and/or to a light serving as an open/not open indicator). When the damper is powered open, the blades of the damper hit the spring rod of the end switch which in turn makes a connection allowing power to flow to the fan and/or light. This set up would be used when it is desirable to ensure that the damper is fully open before the fan starts. Otherwise, with the damper blades are not fully open, the pressure and air velocity produced by the fan may damage the blades, making the damper inoperable.

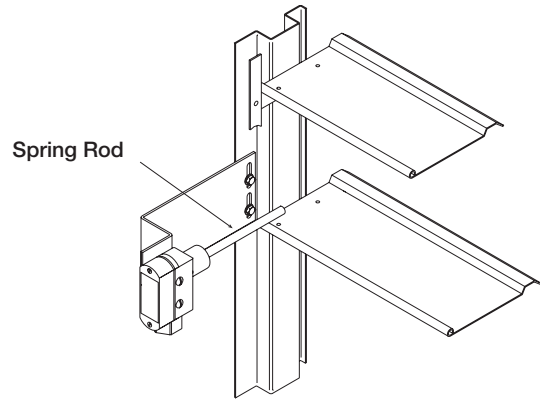

Vertically Mounted Damper



[INSTALLATION](#)

Document Links



[CATALOG](#)



[DAMPER
SELECTION GUIDE](#)



[SPECIFICATIONS](#)



[WARRANTY](#)