

## Installation, Operation and Maintenance Manual

Please read and save these instructions for future reference. Read carefully before attempting to assemble, install, operate or maintain the product described. Protect yourself and others by observing all safety information. Failure to comply with these instructions will result in voiding of the product warranty and may result in personal injury and/or property damage.

### Grease Trapper ESP™

The Grease Trapper ESP™ is a pre-engineered electrostatic precipitator type pollution control unit with integral exhaust fan (available without exhaust fan as an option). The unit is designed to remove grease and smoke particles as well as odor from the kitchen exhaust airstream. This installation manual covers procedures for receiving, installing, and maintaining the unit.

For additional instructions and maintenance information on the integral exhaust fan, when applicable, refer to the fan nameplate to determine model type and visit [greenheck.com](http://greenheck.com) to download the corresponding manual.



### General Safety Information

Only qualified personnel should install this system. Personnel should have a clear understanding of these instructions and should be aware of general safety precautions. Improper installation can result in electric shock, possible injury due to coming in contact with moving parts, as well as other potential hazards. Other considerations may be required if high winds or seismic activity are present. If more information is needed, contact a licensed professional engineer before moving forward.

#### DANGER

Always disconnect power before working on or near this equipment. Lock and tag the disconnect switch or breaker to prevent accidental power up.

#### CAUTION

To reduce the risk of fire, electric shock, and injury be sure to follow the cautions below:

- Before servicing, make sure the unit is properly grounded.
- When servicing the fan, motor may be hot enough to cause pain or injury. Allow motor to cool before servicing.
- Do not operate this unit in an explosive atmosphere.
- Keep all flammable materials (such as gasoline) away from the unit.
- Do not use flammable cleaner on or near the unit.
- The unit should be inspected frequently and the unit and cells should be manually cleaned at proper intervals to prevent a fire.
- Operating temperatures of the airstream should not exceed 130°F.

1. Follow all local electrical and safety codes, as well as the National Electrical Code (NEC), the National Fire Protection Agency (NFPA), where applicable. Follow the Canadian Electrical Code (CEC) in Canada.
2. The rotation of the fan wheel is critical. It must be free to rotate without striking or rubbing any stationary objects.
3. Fan motor must be securely and adequately grounded.
4. Do not spin fan wheel faster than maximum cataloged fan rpm. Adjustments to fan speed significantly affects motor load. If the fan RPM is changed, the motor current should be checked to make sure it is not exceeding the motor nameplate amps.
5. Do not allow the wires to kink or come in contact with oil, grease, hot surfaces or chemicals. Replace immediately if damaged.
6. Verify that the power source is compatible with the equipment.
7. Never open access doors to a duct while the fan is running.
8. The precipitator contains safety electrical interlock switches at all maintenance access doors. Do not attempt to defeat these interlocks.

## Receiving

Upon receiving the product, check to make sure all items are accounted for by referencing items shown on the packing list. Inspect each crate for shipping damage before accepting delivery. Notify the carrier if any damage is noticed. The carrier will make a notation on the delivery receipt acknowledging any damage to the product. All damage should be noted on all the copies of the bill of lading which is countersigned by the delivering carrier. A Carrier Inspection Report should be filled out by the carrier upon arrival and filed with the Traffic Department. If damaged upon arrival, file claim with carrier. Any physical damage to the unit after acceptance is not the responsibility of manufacturer.

## Unpacking

Verify that all required parts and the correct quantity of each item have been received. If any items are missing, report shortages to your local representative to arrange for obtaining missing parts. Sometimes it is not possible that all items for the unit be shipped together due to availability of transportation and truck space. Confirmation of shipment(s) must be limited to only items on the packing list. Remove all other shipping/packing materials including fan tie down straps.

## Handling

Units are to be rigged and moved by the lifting brackets provided or by the skid when a forklift is used. Location of brackets varies by model and size. Handle in such a manner as to keep from scratching or chipping the coating. Damaged finish may reduce ability of unit to resist corrosion.

## Storage

Units are protected against damage during shipment. If the unit cannot be installed and operated immediately, precautions need to be taken to prevent deterioration of the unit during storage. The user assumes responsibility of the unit and accessories while in storage. The manufacturer will not be responsible for damage during storage. These suggestions are provided solely as a convenience to the user.

### INDOOR

The ideal environment for the storage of units and accessories is indoors, above grade, in a low humidity atmosphere which is sealed to prevent the entry of blowing dust, rain, or snow. Temperatures should be evenly maintained between 30°F (-1°C) and 110°F (43°C) (wide temperature swings may cause condensation and “sweating” of metal parts). All accessories (including the main control panel and the keypad/touchscreen user interface) must be stored indoors in a clean, dry atmosphere.

Remove any accumulations of dirt, water, ice, or snow and wipe dry before moving to indoor storage. To avoid “sweating” of metal parts, allow cold parts to reach room temperature. To dry parts and packages use a portable electric heater to get rid of any moisture build up. Leave coverings loose to permit air circulation and to allow for periodic inspection.

### OUTDOOR

Units designed for outdoor applications may be stored outdoors, if absolutely necessary. Roads or aisles for portable cranes and hauling equipment are needed.

The unit should be placed on a level surface to prevent water from leaking into it. The unit should be elevated on an adequate number of wooden blocks so that it is above water and snow levels and has enough blocking to prevent it from settling into soft ground. Locate parts far enough apart to permit air circulation, sunlight, and space for periodic inspection. To minimize water accumulation, place all unit parts on blocking supports so that rain water will run off.

Do not cover parts with plastic film or tarps as these cause condensation of moisture from the air passing through heating and cooling cycles.

### NOTE

The main electrical panel, if stored, shall be stored indoors only in a dry environment protected from the elements.

### Inspection & Maintenance during Storage

While in storage, inspect equipment once per month. Keep a record of inspection and maintenance performed.

If moisture or dirt accumulations are found on parts, the source should be located and eliminated. At each inspection, rotate the fan wheel by hand ten to fifteen revolutions to distribute lubricant on motor. Every three months, the fan motor should be energized. If paint deterioration begins, consideration should be given to touch-up or repainting. Fans with special coatings may require special techniques for touch-up or repair.





Machined parts coated with rust preventive should be restored to good condition promptly if signs of rust occur. Immediately remove the original rust preventive coating with petroleum solvent and clean with lint-free cloths. Polish any remaining rust from surface with crocus cloth or fine emery paper and oil. Do not destroy the continuity of the surfaces. Wipe thoroughly clean with Tectyl® 506 (Ashland Inc.) or the equivalent. For hard to reach internal surfaces or for occasional use, consider using Tectyl® 511M Rust Preventive or WD-40® or the equivalent.

### Removing from Storage

As units are removed from storage to be installed in their final location, they should be protected and maintained in a similar fashion, until the equipment goes into operation. Prior to installing the unit and system components, inspect the unit assembly to make sure it is in working order.

1. Check all fasteners, set screws on the fan, wheel, bearings, drive, motor base, and accessories for tightness.
2. Rotate the fan wheel(s), where applicable, by hand and assure no parts are rubbing.

# Table of Contents

<b>Grease Trapper ESP System Function</b> . . . . .	3
<b>System Components</b>	
Unit Body . . . . .	4
ESP Cells . . . . .	4
Impingement Filters / Mist Eliminator / Filters /	
Carbon Trays . . . . .	4
Component Quantities . . . . .	4
Remote Mounted Detergent Dispenser. . . . .	4
Remote Mounted System Control Panel . . . . .	5
Fire Cabinet . . . . .	5
<b>PCU Field Assembly</b>	
Unit Modules . . . . .	5
Terminal Enclosure . . . . .	6
Attaching Fan . . . . .	6
<b>Installation</b>	
Rigging and Placing Equipment . . . . .	7
Ductwork Connections . . . . .	7
Cells and Carbon Trays . . . . .	7
<b>Plumbing Connections</b>	
Detergent Dispenser . . . . .	8
Wash Manifolds . . . . .	9
<b>Electrical</b> . . . . .	9
<b>Fire System</b>	
Ansul® . . . . .	10
<b>Initial System Start-Up</b> . . . . .	11
<b>Sequence of Operation</b>	
Normal . . . . .	11
Wash . . . . .	12
<b>Controller Setup and Tutorial</b> . . . . .	13-14
A.  Clock. . . . .	15
B.  Input/Output . . . . .	15
C.  Service. . . . .	16-21
D.  Manufacturer . . . . .	21
<b>Keypad Navigation</b> . . . . .	22
<b>Touch Screen Navigation</b> . . . . .	23-26
<b>Variable Frequency Drive Information</b> . . . . .	27-28
BMS Points List. . . . .	29
<b>Maintenance</b> . . . . .	30-31
<b>Unit Layout</b> . . . . .	31
<b>Field Wiring Diagrams</b> . . . . .	32-33
<b>Wash Water Plumbing Schematic</b>	
Drain Line Plumbing . . . . .	34
Detergent Dispenser Assembly. . . . .	34
<b>Troubleshooting</b> . . . . .	35
<b>Maintenance Log</b> . . . . .	Backcover
<b>Our Commitment</b> . . . . .	Backcover

## Grease Trapper ESP System Function

Grease Trapper ESP is an electrostatic precipitator pollution control unit (PCU), with an additional carbon filtration module designed for two specific functions:

- Remove smoke/grease particles from kitchen exhaust
- Remove odor from kitchen exhaust

### NOTE

- Grease Trapper ESP must be connected to a listed exhaust hood assembly and must be installed in accordance with local building codes, NFPA 96 and NEC.
- The unit must be installed with a minimum 12 inch clearance to combustible materials on top of unit and six inches on the sides and bottom.

A mechanical impingement pre-filter removes large airborne particles from the incoming airstream prior to reaching the ionizer cell. The permanent electrostatic collector section removes grease and smoke particles from the airstream using a high voltage ionizer cell(s). The ionizer imparts a positive charge on the grease and smoke particles as they pass. These particles are then repelled by positively charged plates and collected on negatively charged plates. Upon completion of each cooking day, a wash sequence is initiated for the self-cleaning function of the electrostatic cell via the remote mounted control panel. The mesh mist eliminator filter prevents wash water from entering the carbon filtration section(s) of the unit.

### NOTE

Do not use this unit for applications with high concentrations of water vapor, or other matter, that is highly conductive if condensed in the airstream. Heavy water vapor can causing continuous electrical shorting within the ESP cells, which does not allow the unit to collect cooking particulate and perform as designed.

There are two configuration options for the Grease Trapper ESP PCU's. The standard unit will have two ESP modules and one carbon filtration section for use with light, medium and heavy duty cooking. For solid fuel applications which will contain a greater quantity of grease, smoke and odors, the solid fuel unit should be selected. The solid fuel unit will contain three ESP modules and two carbon filtration modules.

### NOTE

This unit should NOT be installed in applications where incoming airstream at the inlet of the unit is capable of exceeding 130°F.

### NOTE

Grease Trapper ESP is designed to remove sub-micron, airborne particulate generated from cooking processes. This system is **NOT INTENDED** to eliminate regular hood and ductwork cleaning and service. Improper care and maintenance of this system and associated hoods and ductwork may present a fire hazard.



# System Components

## NOTE

The installation criteria for each of the system components shown below should be considered when selecting a site for install. For further detail on installing the components, refer to the INSTALLATION section on page 7.

## Unit Body

The unit body is shipped on a mounting rails ready for installation. If the unit was ordered with an exhaust fan, typically the fan will also be mounted on the same set of rails as part of the PCU assembly. Unless specified and built for outdoor use, the PCU must be mounted indoors and be protected from weather. The unit should be easily accessible for service personnel. (1) One-inch water supply line and (1) two-inch waste water drain line is required at the unit for the system's wash function.

Power packs (power supply boxes) are attached to hinged cell access doors of the cabinet assembly which are wired to the terminal enclosure (disconnect box) mounted to the rail below. High voltage feed-through pins safely transfer voltage from power supply to the cells located inside the unit. Power supplies are self-protecting against overloads (which can be caused by contaminant build up that leads to short circuits in ionizer and collector sections) and are self regulating from AC input voltage variations from 108 - 264 VAC.

## ESP Cells

ESP cells will ship in separate crate to protect them during shipping. Cell quantities for each stage are based on unit size.

Cells have an ionizer section and collector section. Ionizer section includes spiked ionizer plates that are charged with 12,000 VDC. Collector section includes alternating plates between ground (0 VDC) and 6,000 VDC potential. Cells are fed voltage through high voltage feed-through pins that are insulated from the unit housing. These pins contact brass plungers located on the side of the cell near the bottom. If a module has multiple cells, power is passed from cell to cell through these brass plungers coming into contact with the pins on next cell.

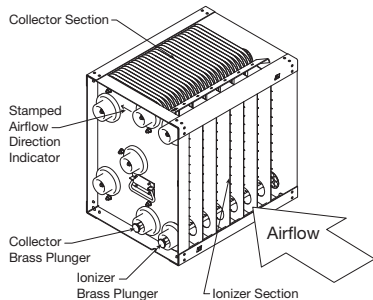

Left Hand Access Unit Cell

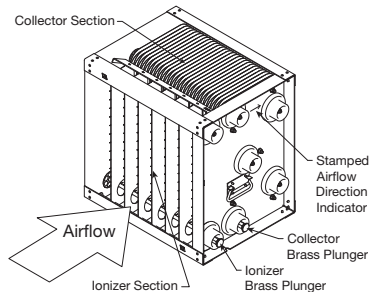

Right Hand Access Unit Cell

The total current to both the ionizer section and collector section is below 6 mA.

## Impingement Filters / Mist Eliminator Filters / Carbon Trays

Impingement filters and mist eliminator filters will ship installed in the unit. Carbon trays will ship in a separate container. Filter quantities for each stage are based on unit size.

Each carbon filter is a 20 x 20 x 2 inch, 12 lbs, and contains coconut shell carbon, standard. Max designed velocity across each filter is 90 ft/min.

## Component Quantities

STANDARD UNIT				
Housing Size	Impingement Filter	ESP Cell	Mist Eliminator Filter	2" Deep Carbon Trays
15	1	2	1	6
30	2	4	2	12
45	3	6	3	18
60	4	8	4	24
90	6	12	6	36
SOLID FUEL UNIT				
15	1	3	1	12
30	2	6	2	24
45	3	9	3	36
60	4	12	4	48
90	6	18	6	72

## Remote Mounted Detergent Dispenser

A 30 gallon remote mounted detergent dispenser equipped with 1/2 hp pump is included as part of the electrostatic collector self-wash system. Solenoid valves, pressure gauge, ball valve, y strainer, and backflow preventer **are to be provided by others**. The detergent dispenser must be mounted indoors on a solid, level foundation, as close to the cabinet assembly as possible, and in a freeze protected location accessible to maintenance personnel. The 1/2 inch line from the detergent dispenser must be connected to the water supply line prior to the precipitator. Refer to the PLUMBING section for details on plumbing connections.



## System Components - continued

### Remote Mounted System Control Panel

The 115 VAC system control panel fed from a 30A building breaker allows the user to interface with the unit and controls operation, as well as monitors wash and other functions. Field wiring connects the system control panel to the terminal enclosures on the unit, and works in conjunction with the unit's power supplies and high voltage ESP cells. The system control panel is designed to be mounted indoors (NEMA-1) in an area easily accessible to daily operational staff. Allow adequate room from the face of the panels for door swing clearance and servicing.

### Fire Cabinet

The fire cabinet should be mounted as close to the Pollution Control Unit as possible, typically within 5 feet. Unless the fire cabinet was provided with an outdoor cabinet and heater, the cabinet should be mounted indoors and must be kept above freezing.

### PCU Field Assembly - if applicable

If unit is shipped in sections, each section will **need to be welded in the field**.

#### Unit Modules

1. Remove (4) 5/16 inch mechanical fasteners that attach each module to the rails.
2. Remove 5/16 inch mechanical fasteners that attach each module to the next adjacent module. PCU housing size can be found in the model number on tag on side of unit.

Housing Size	Number of Mechanical Fasteners
15	3
30, 45	4
60, 90	6

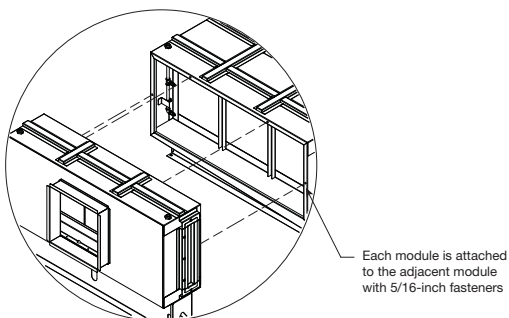

#### NOTE

Doors will have to be opened and/or removed to access fasteners inside of modules. A 1/2 inch socket is required to remove door bolts.

3. After rails and modules have been moved to desired location, the modules and rails can be reassembled.

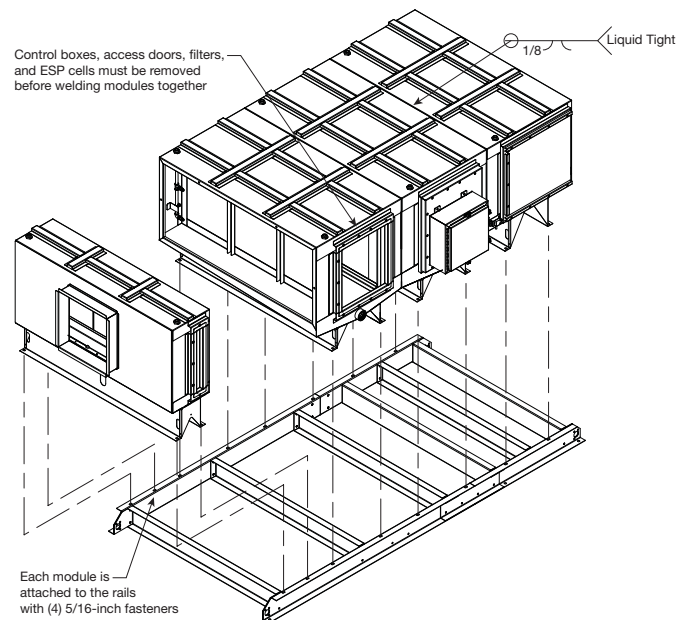

4. It is recommended to reattach the fasteners from step 2 to properly align the modules with each other, but fasteners are not required when the modules are welded together from the outside.

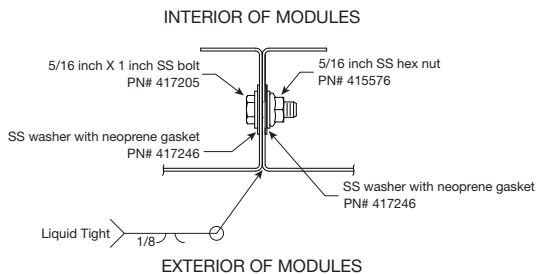

5. Make sure all control boxes, access doors, filters and cells are removed from the modules before welding modules together.
6. Fully weld modules together on all four sides on the outside of the unit. Welds must be liquid tight.

## Terminal Enclosure

1. The bottom of each terminal enclosure mount needs to be attached to the rail with (2) 5/16 inch fasteners (provided by factory).
2. The top of each terminal enclosure mount needs to be welded to the side of the modules.

### NOTE

Be sure terminal enclosures do not block module drains or doors.

3. Refer to wiring diagram provided with the unit control panel for more information. Limit switches (mounted on each module) need to be wired to terminal enclosures.
4. Plugs on power pack enclosure (ESP modules only) need to be plugged into the terminal enclosures.

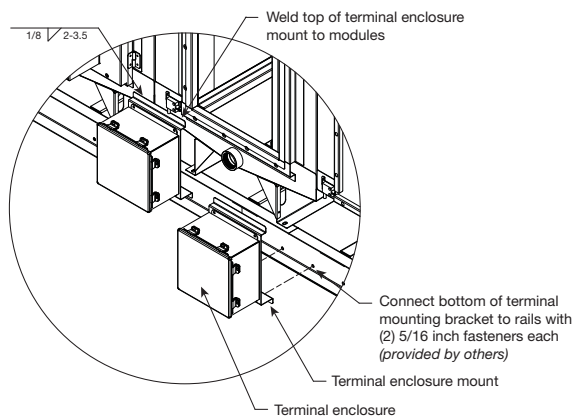
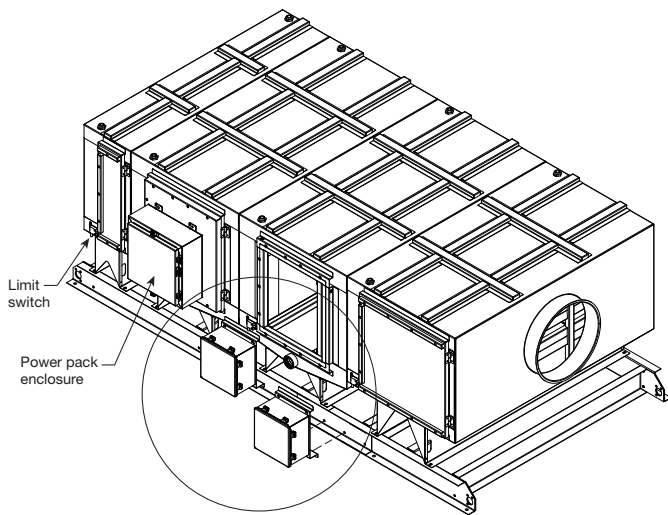

## Attaching Fan

The ESP fan is shipped bolted to unit body and rails. If the unit was requested to be disassembled in the field, the unit body-to-fan connection has not been sealed.

1. To disassemble in the field, remove mechanical fasteners that attach the companion flange and fan to the unit body.
2. Remove mechanical fasteners that attach the fan to the isolators on the rails.

After fan and unit body have been moved to desired location, the fan can be sealed and reattached to the unit body and rails.

3. To seal the fan to unit body connection, apply fire rated caulk (3M Fire Barrier Sealant CP25WP+ or equivalent) to fan inlet flange. Make sure to apply caulk around each bolt hole. Caulk to be located outside of silicon gasket mounted during step 4.

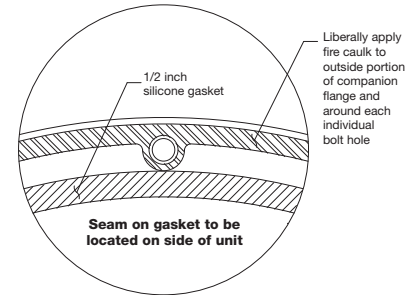

Make sure to apply caulk around each bolt hole. Caulk to be located outside of silicon gasket mounted during step 4.

4. Attach 1/2 inch silicone gasket around fan inlet flange. Silicone gasket to be located inside of caulk applied in step 3 (seam of gasket to be located on the side of unit).

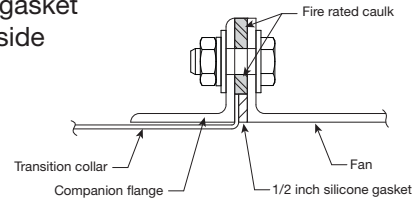

5. To reassemble locate fan on isolators on rails.
6. Reattach fasteners for companion flange removed in step 1.
7. Reattach fasteners attaching fan to isolators removed in step 2.

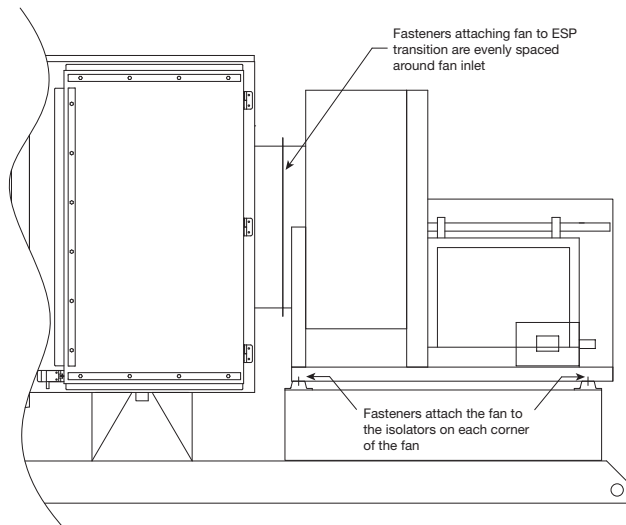

# Installation

## Rigging and Placing Equipment

1. The unit is furnished with lifting lugs at the four corners. For corner weights, reference the unit's submittal drawings.
2. Use a crane and a set of spreader bars hooked to all four factory lifting lugs to lift the unit.
3. Field weight will vary depending upon final selections such as fan type, accessories, etc. Approximate weights are shown in the table.
4. The unit can be positioned on a base or roof deck suitable for this purpose.
5. The unit must be anchored to its base/roof deck.
6. Alternatively, the unit may be suspended from an adequate overhead structure, using suitable undercarriage or hanging rods (by others). If suspended a cradle or support structure must be provided by others to support unit from bottom. All hanger brackets/lifting lugs must be used to ensure proper support. The unit must also be hung level to ensure proper operation.
7. A service clearance of 36 inches must be provided on the access door side of the unit.

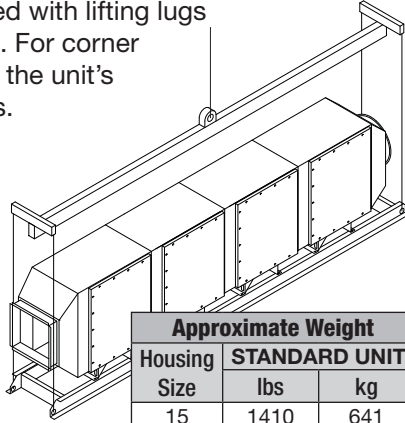

Approximate Weight		
Housing Size	STANDARD UNIT	
	lbs	kg
15	1410	641
30	1710	777
45	2120	964
60	2765	1257
90	3315	1507
Housing Size	SOLID FUEL UNIT	
	lbs	kg
15	1860	845
30	2295	1043
45	2860	1300
60	3660	1664
90	4390	1995

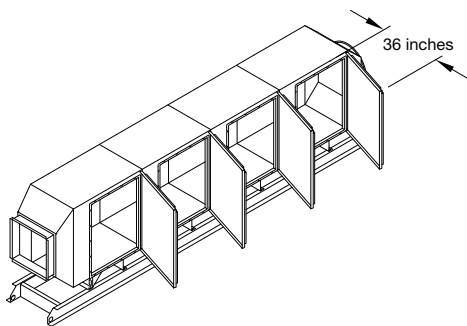

8. A minimum 12 inch clearance must be maintained between the top and 6 inches on each side and bottom of this unit and any combustible material.

## Ductwork Connections

Ductwork must conform to IMC and SMACNA guidelines.

All factory-built grease duct needs to be constructed in accordance with ANSI/UL 1978 and should be manufactured and installed in accordance with their listing.

All field-built grease ductwork must be constructed in the following manner per NFPA 96, unless otherwise specified by the local authority having jurisdiction (AHJ):

**Materials** - Ducts shall be constructed of and supported by carbon steel not less than 1.37 mm (0.054 in.) (No. 16 MSG) in thickness or stainless steel not less than 1.09 mm (0.043 in.) (No. 18 MSG) in thickness.

**Installation** - All seams, joints, penetrations, and duct-to-hood collar connections shall have a liquid-tight external weld.

Units intended for indoor mounting have an outlet mounting flange provided on the outlet of the fan. Outlet ductwork from the exhaust fan is required to be per the above mentioned methods unless otherwise specified by the local authority having jurisdiction (AHJ).

### NOTE

Ductwork should be properly insulated to prevent formation of condensation through temperature change. Condensation that occurs in ductwork will short circuit ionizing-collecting cells.

## Cells and Carbon Trays

Open ESP cell and carbon tray access doors using 1/2 inch socket wrench to remove all bolts.

Insert cells into the ESP module(s) in the unit, making sure the brass plungers are on the bottom facing **towards** you and the airflow arrow stamped on each cell is pointing towards the fan. ESP cells should be pushed in by the one next in the row.

For example, the second cell pushes the first cell, third cell pushes the second, etc. The last cell installed should be no more than 4 inches ( $\pm 1/8$  inch) from the edge of the cell to the edge of the frame.

Insert carbon trays into the carbon module(s) in the unit. Make sure trays are inserted where gasketing material is orientated on the left and right hand side, **NOT the top and bottom**, so there is a seal against the filter next to them.

After all cells and filters are properly installed, refasten unit doors. Torque the bolts to 60-70 in-lbs. Bolts should be started by hand prior to using an impact driver or socket.

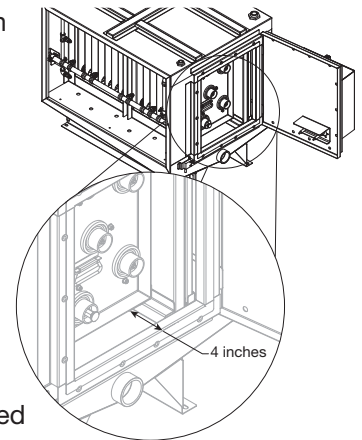

# Plumbing Connections

## NOTE

All water piping exposed to freezing temperatures must be trace heated and insulated to prevent damage to the unit.

Once all system components are installed, plumbing connections for the system can be made. It is recommended that plumbing connections be done prior to making electrical connections.

From the building, a 1-inch (refer to drawings) hot water line is required for connecting the wash system. Recommended water temperature is 140-180°F at 40 psi pressure. Make sure water pressure does not exceed 50 psi. Refer to the chart for information on water and detergent quantity requirements. Install the quarter turn ball valve (by others) at the incoming water source to allow the water to be turned off for servicing. Next, install the strainer (by others), backflow preventer (by others), pressure gauge (by others), and 24 VAC solenoid valve (by others) respectively. Locate these items along the incoming water line in a location convenient for inspection/servicing.

Approximate Water and Detergent Used per Wash Cycle (gallons)*				
Housing Size	STANDARD UNIT		SOLID FUEL UNIT	
	Water	Detergent	Water	Detergent
15	70	1	105	2
30	140	1	210	2
45	210	2	315	4
60	220	2	330	4
90	330	2	495	4

Water usage numbers shown above are assuming factory default wash cycle times. Actual water and detergent required may be different based on the cooking load, appliance type, and cooking frequency/time.

\*Assuming 40 psi water pressure

## Detergent Dispenser

The detergent dispenser supplies detergent to the wash system during the WASH mode.

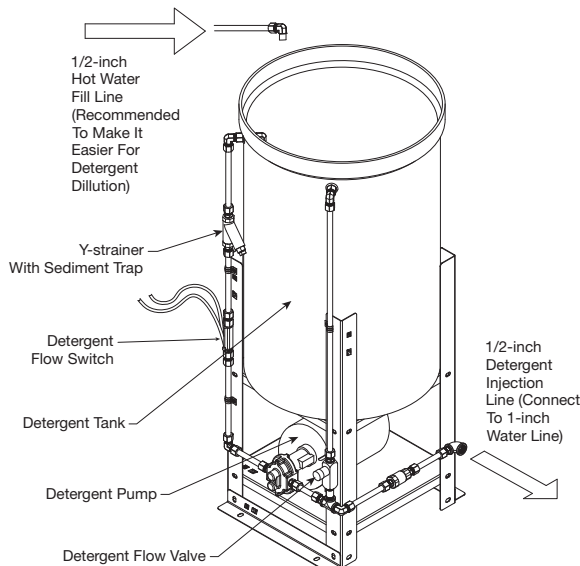

When the unit is washing and the wash sequence is calling for detergent, a pump housed underneath the detergent tank pumps the detergent into the hot water line. A Y-strainer is responsible for removing debris and sediment from reaching the pump. A flow switch determines if detergent is flowing when detergent is being injected (if the flow switch doesn't close within a time period upon detergent pump running, this will trigger a low detergent fault). A detergent flow valve is responsible for diverting some detergent back into the tank. Turning the flow valve knob clockwise (closing the valve) will force more detergent into the hot water line and to the unit during a wash. Turning the flow valve knob counter-clockwise (opening the valve) will force more detergent back into the tank during a wash. A series of colored rings on the flow control valve

indicate how opened/closed the valve currently is. This can be adjusted as needed based on the detergent required for the wash cycle, but should start with setting the valve so that the **red ring is visible**, (see Flow Valve image) which should equate to roughly 0.6 GPM. Adjustments to the flow control setting should be done in small increments over a period of several wash cycles.



**Flow Valve**

This flow valve may be locked into place by a black hex head set screw located on the bottom of the flow valve, just below the adjustable knob. Loosen the set screw before making an adjustment using a 2-mm Allen wrench.

From the pump located on the base of the detergent dispenser, connect a 1/2-inch piping connection for the detergent supply to the 1-inch water supply line. A quarter turn ball valve (by others) can be installed on this line if necessary for servicing. The connection of the 1/2-inch detergent supply line to the 1-inch water supply line should be made within 10 feet of the cabinet assembly.

## NOTE

Upon the system detecting no detergent flow for the detergent alarm delay time, the system will go into a low detergent alarm and the detergent pump will be immediately shut off. The low detergent fault can be manually reset (see page 14 for details), or it will automatically reset if detergent flow is detected upon the next wash cycle when detergent injection is taking place.

Pump should be located as close to unit as possible, on same floor. Maximum distance recommended from detergent pump to unit is 10 feet.



## Plumbing Connections - *continued*

### Wash Manifolds

The unit is supplied with 1-inch wash headers located at the top of each ESP module. Connect the hot water supply line to the wash headers at the top of the ESP module. Bring a 2-inch waste water drain piping connection with P trap to the drain pipe on the side of the ESP module. The trap drain line water column for the drain should be sized for the total system resistance plus 1 in. wg.

For more information, refer to the plumbing schematic located on page 34.

The Grease Trapper ESP PCU will be supplied with a detergent tank and pump and connection headers on each module. All other plumbing components and piping will be provided by others. Follow all applicable plumbing codes and best practices when installing system.

Required Plumbing Components (Provided by Others)	
Quantity	Item Description
3	Ball Valve
1	Y Strainer
2	Backflow Preventer or Check Valve
1	Pressure Gauge
4	24 VAC Solenoid Valves - Standard Unit
5	24 VAC Solenoid Valves - Solid Fuel Unit

## Electrical

Once all system components are installed, electrical connections for the system can be made. It is recommended that plumbing connections be done prior to making electrical connections.

### CAUTION

RISK OF ELECTRIC SHOCK. All wiring to be done by qualified personnel only.

### NOTE

All wiring must be done according to the equipment data plate information, NEC (National Electrical Code NFPA 70), and local codes.

### NOTE

All wiring must be permanently installed in conduit. Under no circumstances should extension cords be used to connect the source of electrical supply to the equipment.

### NOTE

An earth ground must be provided to the unit assembly housing and main control panel. If shipped loose for remote mounting, terminal enclosures must be provided with earth ground. The detergent pump motor and solenoid valve must also be appropriately grounded.

The Grease Trapper ESP PCU will require additional field wiring for proper installation. The main control panel will be shipped loose and is designed to be mounted indoors. A typical field wiring diagram is shown on page 32. Refer to the unit specific wiring diagram located on the inside of the door of the system control panel for unit specific wiring that is required.

## Fire System

The Pollution Control Unit (PCU) is furnished with factory pre-piped fire suppression nozzles. Field connection, tanks, controls, fusible link detectors, and commissioning is provided and installed, based on specifications at time of order. The Authority Having Jurisdiction (AHJ) may require additional protection.

The fire system must be installed and operational to maintain the UL Listing of the unit. Refer to the drawings below for information on field piping the fire system to the unit. The release and tanks should be mounted no more than 5 feet away from the PCU unit.

### ANSUL

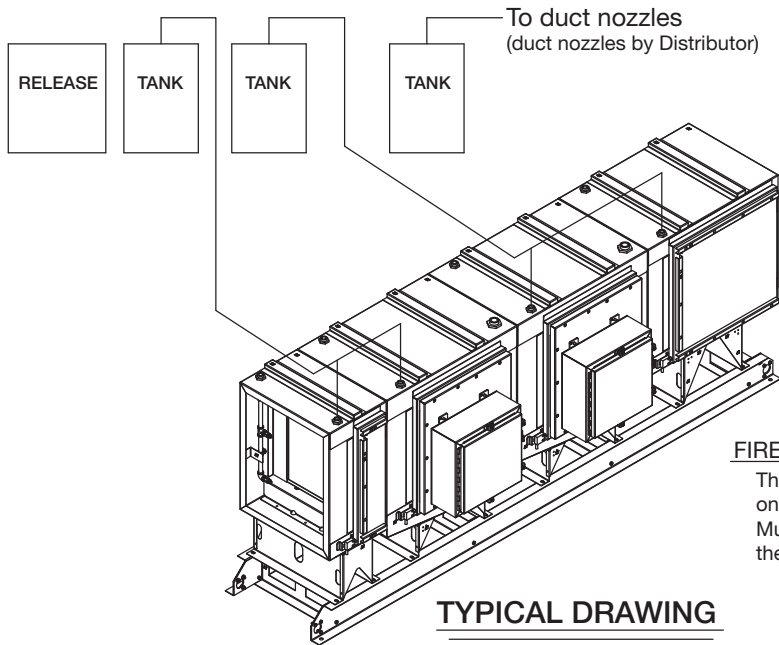

#### FIRE SYSTEM DISTRIBUTOR / FIRE SYSTEM INSTALLER:

There are two quik-seals on each module. Connection to only one of the quik-seals on each module is required. Multiple quik-seals are provided for situations where there are obstructions to the connection point.

- Do not install fire piping in front of doors on module. Must have 36 inches of clearance.

## Initial System Start-Up

1. Verify unit is installed properly and all field water and electrical connections have been made.
2. Check that all ESP cells have been installed properly. There is a directional arrow that indicates the direction of the proper airflow. If cells are not installed in the proper direction, the unit will not operate correctly.
3. Close and properly fasten the doors on the unit to ensure the door limit switches are closed.
4. Turn on electrical power to control cabinet and exhaust fan.
5. Turn on fan disconnect.
6. Turn on the disconnect switch on the PCU terminal enclosures to energize the power packs.
7. Press the fan button on the user interface to start the fan. The green indicator lights on the terminal enclosure(s) should illuminate indicating the power supply is powering cells. Some electrical arcing (audible snapping and cracking) is normal at initial power up as leftover debris in the duct and unit may occasionally get caught inside the cells. When the ionizer section on an ESP cell is arcing, the green indicator light on the terminal box will shut off, and the red indicator light will illuminate temporarily. When the collector section of an ESP cell is arcing, the green indicator light on the terminal box will shut off, and both the red and green indicator lights will remain off temporarily. Arcing should subside after a short period of time. If arcing continues, reference page 35 for troubleshooting assistance.

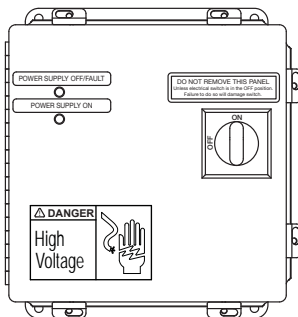

**Housing Size**  
15, 30, 45

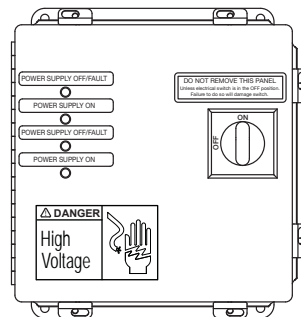

**Housing Size**  
60, 90

- **RED** indicates an ionizer fault within a cell
- **GREEN** indicates normal operation
- **NO LIGHTS** indicates power supply is off OR collector fault within a cell

8. The indicating lights on the terminal enclosure(s) will indicate status of the power supplies. Terminal enclosure indicator lights will remain off unless fan is running.

9. Check for alarms on the system controller. Correct any alarms that may be displayed (See page 14 for details).
10. System should now be ready for operation.

### NOTE

As a safety precaution, the system will only operate in the NORMAL mode when the access doors of the unit are completely closed and the terminal box disconnect switch is in the ON position.

If the plunger of the safety switch on all of the doors is not fully depressed, the red FAULT light on the main controller (PLC) will illuminate and the unit will not start. Do not attempt to operate the unit with the access doors open or bypass the safety.

## Sequence of Operation

The operation of the Grease Trapper ESP system falls into two main categories:

- 1. NORMAL:** System collects smoke and grease particulate from the airstream.

The unit can be started by pressing the fan button on the user interface or by closing the remote run contact (terminals RE-1A and RE-1B). The remote run command is a contact that can be wired to the kitchen control panel, timeclock, or any other contact closure desired to call for the system to run.

### NOTE

BOTH the keypad fan button needs to be disengaged AND the remote run contact needs to be open in order for the fan to shut off. A call for the fan to run will not allow for a wash to start, which will prevent the cells from being cleaned.

During normal operation, as the grease enters the unit, it will pass through an impingement filter that is designed to remove the large grease particles. After passing through the impingement filter, it will enter the ESP module(s) which will remove the grease particles and smoke from the airstream through a process of electrostatic precipitation. Upon leaving the ESP modules, the air then passes through a mist eliminator filter which stops water from entering the carbon filters during the wash down process and also helps protect the carbon filter section from grease build-up. The air then enters the carbon filtration section which removes the odors from the airstream.

### Normal Mode

- Exhaust Fan - Running
- Terminal Enclosure Indicator Lights - Green
- Main Solenoid Valve - Closed
- Detergent Pump - Off

## Sequence of Operation - *continued*

**2. WASH:** System goes through cycles to clean and dry dirty ionizing-collecting cells

The wash cycle is recommended to be performed daily on the unit and uses an automated wash down sequence to remove the grease that has been collected on the ESP cells. The length of time and frequency of washing will be determined by the grease load in the airstream. The times shown are the factory settings but can be adjusted as needed based on site conditions.

The wash cycle can be started three different ways:

1. User presses the wash button on the keypad or touch screen.
2. An external wash contact is closed (terminals WS-1A and WS-1B).
3. The controller can be set up to wash the unit automatically based on a schedule set up on the controller.

The wash sequence will wash each ESP module using the steps below. For units with multiple ESP modules, the wash sequence will repeat itself for each module with the exception of the drip dry and fan dry sequence. The drip dry and fan dry portion will start once all of the modules have completed washing and are used to dry the entire unit before placing it back into service.

**Wash Override:** The wash sequence can be stopped by pressing the wash button on the user interface. This will cancel the wash sequence and return the PCU to normal operation. When calling for a wash or during the wash sequence if the fan is turned on either by the fan button, remote fan enable contact, or the fire system is activated the wash sequence will stop and the exhaust fan will turn on.

### Pre-Soak

- Exhaust Fan - Off
- Terminal Box Indicator Lights - Off
- Main and ESP Module Solenoid Valve - Open
- Detergent Pump - Off
- Time - 3 minutes

### Detergent

- Exhaust Fan - Off
- Terminal Box Indicator Lights - Off
- Main and ESP Module Solenoid Valve - Open
- Detergent Pump - On
- Time - 30 seconds (Housing sizes 15 and 30)  
1 minute (Housing sizes 45, 60 and 90)

### Soak

- Exhaust Fan - Off
- Terminal Box Indicator Lights - Off
- Main and ESP Module Solenoid Valve - Off
- Detergent Pump - Off
- Time - 3 minutes

### Rinse

- Exhaust Fan - Off
- Terminal Box Indicator Lights - Off
- Main and ESP Module Solenoid Valve - Open
- Detergent Pump - Off
- Time - 4 minutes

### Detergent

- Exhaust Fan - Off
- Terminal Box Indicator Lights - Off
- Main and ESP Module Solenoid Valve - Open
- Detergent Pump - On
- Time - 30 seconds (Housing sizes 15 and 30)  
1 minute (Housing sizes 45, 60 and 90)

### Soak

- Exhaust Fan - Off
- Terminal Box Indicator Lights - Off
- Main and ESP Module Solenoid Valve - Closed
- Detergent Pump - Off
- Time - 3 minutes

### Rinse

- Exhaust Fan - Off
- Terminal Box Indicator Lights - Off
- Main and ESP Module Solenoid Valve - Open
- Detergent Pump - Off
- Time - 4 minutes

### Drip Dry

- Exhaust Fan - Off
- Terminal Box Indicator Lights - Off
- ESP Module Solenoid Valve - Closed
- Detergent Pump - Off
- Time - 1 minute

### Fan Dry

- Exhaust Fan - On
- Terminal Box Indicator Lights - Off
- ESP Module Solenoid Valve - Closed
- Detergent Pump - Off
- Time - 90 minutes





# Controller Setup and Tutorial







The user can access the main menu by pressing the  button.

Within the programmable logic controller, factory set points can be modified to configure the system for specific functions if necessary. All parameters are shown in this section.





Some of the menus require the user to enter a password in order to enter the menu. The service password is 1000 and is entered by pressing the   to change the number and to advance the cursor, press the  button.

The DDC controller is located in the unit control panel. The face of the controller has six buttons, allowing the user to view unit conditions and alter parameters. The DDC controller is pre-programmed with easy to use menus.

To change the display contrast, hold the Alarm  and Program  buttons simultaneously while pressing the  and  arrows.

If equipped, the keypad user interface connects via a factory-provided RJ-25 cable to the J10 port on the controller.

Information regarding most of the settings within the Controller U1 are provided in this Installation, Operation and Maintenance Manual.



Keypad Navigation		
	Escape	Allows the user to exit the current menu, jumping to the Main Menu.
	Up   Down	The arrow buttons allow the user to scroll through different screens and adjust parameters.
	Alarm	Button will blink red, indicating an alarm condition. Press to review current alarms. To review previous alarms, access the DATA LOGGER in the alarm menu.
	Enter	A. In screens with adjustable parameters, pressing the Enter button moves the cursor from the upper left corner of the screen to the parameter. The arrow buttons can then be used to adjust the parameter. B. To move to the next parameter on the same screen, press the Enter button. C. To save the change, press the Enter button until the cursor moves back to the upper left corner of the screen.
	Program	Pressing the Program button allows the user to enter the Main Program Menu.

## Example of Parameter Adjustment

Exhaust 1 Setpoints		
	Temp	Speed
Low:	90.0°F	50.0%
High:	115.0°F	100.0%
Current Temp:	70.0°F	

Once you enter into a menu that has adjustable parameters, the cursor always begins in the upper left corner of the display and will be blinking. Press the  button to move the cursor down for parameter adjustment.

Exhaust 1 Setpoints		
	Temp	Speed
Low:	90.0°F	50.0%
High:	115.0°F	100.0%
Current Temp:	70.0°F	

Once the cursor has reached the desired parameter, press the   buttons to adjust the value.

Exhaust 1 Setpoints		
	Temp	Speed
Low:	90.0°F	50.0%
High:	115.0°F	100.0%
Current Temp:	70.0°F	

When satisfied with the adjustment, press the  button to save the parameter. **When finished, make certain the cursor is in the upper left corner. If the cursor is not in the upper left corner, the changes will not be saved.** The cursor must be in the upper left corner to enable screen advancement.

## Main Menu Overview

If the PCU panel is configured with a touch screen, the controller will revert back to a PCU status loop. This loop includes several screens to view the operating conditions of the unit. If configured, scroll through the menu screens by using **↑ ↓** buttons. **Screens with a dashed line border are dependent upon the configuration and may not appear for every system.**

PCU Exhaust Fan	
Exhaust:	On
Speed:	XXX%
System Status:	



### PCU STATUS:

This screen will display the status of the PCU exhaust fan as well as display fan speed.

## Example of Alarms

If an alarm occurs, the  button will flash red on the controller and the keypad (if connected).

Alarms
Press DOWN to review current alarm(s). Press ESC to exit. Press ALARM to reset.

To navigate to the alarm menu, press the  button once. Press the **↓** button to scroll through any current alarms. Once the problem causing the alarm has been corrected, all alarms except low detergent will automatically clear. Pressing the  button will clear the low detergent fault if it needs to be manually cleared. If the alarm cannot be cleared, the cause of the alarm has not been fixed.

*** ALARM ***
Exhaust Fan Alarm Check exhaust fan starter or VFD.

This is an example of an exhaust fan fault.

Alarms
No active alarm  Press ENTER key to access ALARM HISTORY log.

This screen appears if there are no active alarms.

To view all saved alarms, press the **←** button to enter the DATA LOGGER. For more information, see the Data Logger menu.

Alarm	Alarm Description
Low Detergent	No detergent flow or empty detergent tank*
Fan Fault	Failure of the exhaust fan
PCU Door Fault	One of the doors to the unit is open
Power Supply Failure	Power supply has failed
Fire Detected	Indicates fire in either the kitchen or PCU unit

\*Depending on the software version for the controller provided with your specific system, the low detergent alarm may have to be cleared manually. If your system requires you to clear the fault manually, fill the detergent tank with the 1:1 detergent/water mix, then clear the alarm from the system from the user interface. If your system automatically clears low detergent faults, fill the detergent tank with 1:1 detergent/water mix, and the fault will be cleared upon the next wash cycle.

## A. Clock

The **Clock** menu allows the user to view and alter the time and date. The user can also adjust the daylight savings time setting.

Clock	
02:00:00PM	01/01/18
Date:	MM/DD/YY
Hour:	15:30
Day:	Monday

### ***THE CLOCK SCREEN ALLOWS THE USER TO ADJUST THE TIME AND DATE.***

The time/date will not be adjustable on the controller if the user interface is the touch screen.

Clock	
DST:	Enable
Transition time:	60min
Start:	LAST SUNDAY
in MARCH	at 2.00
End:	LAST SUNDAY
in OCTOBER	at 3.00

### ***THIS SCREEN ALLOWS THE USER TO ADJUST DAYLIGHT SAVINGS TIME SETTING.***

The Daylight Savings time feature can be adjusted to meet the current daylight savings time requirements.

Holiday Configuration	
Number:	4
Wash and fan schedules will not operate during holidays.	

### ***THIS SCREEN ALLOWS THE USER TO ADD AND ADJUST HOLIDAY TIMES.***

The user can add up to 16 holidays. Adding holidays will prevent the wash and fan scheduler controlling the wash/fan during the days selected.

Holiday X	
1:	0/ 0 - 0/ 0
2:	0/ 0 - 0/ 0
3:	0/ 0 - 0/ 0
4:	0/ 0 - 0/ 0

## B. Input/Output

The **Input/Output** menu allows the user to quickly view the status of the controller inputs and outputs.

Analog Input	
Fan Speed (AIN1)	
Input Ch: B001	0.0%

To manually control I/O values, go to the **Service menu > Service settings > I/O Manual Control**.

Similar screens appear for all controller inputs and outputs.

*Your controller may not utilize the input shown. See unit wiring diagram for your specific configuration.*

Digital Input	
On / Off (DIN1)	
DI 1 Status:	Open

Similar screens appear for all controller inputs and outputs.

*Your controller may not utilize the input shown. See unit wiring diagram for your specific configuration.*

Relay Output	
Exhaust Relay (DOU1)	
Relay 1 Status:	OFF

Similar screens appear for all controller inputs and outputs.

*Your controller may not utilize the output shown. See unit wiring diagram for your specific configuration.*

Analog Output	
Fan Speed (AOUT1)	
Output:	5.00vdc

Similar screens appear for all controller inputs and outputs.

*Your controller may not utilize the output shown. See unit wiring diagram for your specific configuration.*



## C. Service

The **Service** menu allows the user to access several sub-menus regarding controller information, controller overrides, operating hours, BMS configuration, I/O manual management and wash settings. By accessing the **BMS Configuration** sub-menu, the user can adjust BMS protocol settings. (BACnet®, LonWorks®, Modbus)

### C. Service

#### a. System Information

##### Information

Greenheck Fan Corp.

Version:	1.0.006
Date	07/19/19
Bios:	6.27 09/07/04
Boot:	5.00 09/07/04

The **System Information** sub-menu displays information about the controller and the program loaded on the controller.

---

**THIS SCREEN SHOWS VERSION, BOOT AND BIOS INFORMATION. BIOS AND BOOT PERTAIN TO THE CONTROLLER'S FIRMWARE AND OPERATING SYSTEM.**

---

### C. Service

#### b. Power Supply

##### Power Supply Settings 1

Power Supply Operating  
Signal Voltage

Pass1:	3.0vdc	(12.0kV)
Pass2:	3.0vdc	(12.0kV)
Pass3:	3.0vdc	(12.0kV)

The **Power Supply** sub-menu allows the user to view and adjust the power supply settings.

---

**THIS SCREEN ALLOWS THE USER TO ADJUST OUTPUT SIGNAL POWER TO THE POWER SUPPLIES AND THE CORRESPONDING kV OUTPUT.**

---

This should only be adjusted on factory advisement only. Default is 3.0vdc (12kV).

##### Power Supply Settings 2

Power supply initial reset  
attempts before alarm: 10

---

**THIS SCREEN ALLOWS THE USER TO ADJUST POWER SUPPLY RESET ATTEMPTS UPON A FAULT BEFORE ENTERING ALARM.**

---

Default is 10 attempts.

##### Power Supply Settings 3

Power supply alarm  
reset delay: 10 minutes

---

**THIS SCREEN ALLOWS THE USER TO ADJUST POWER SUPPLY RESET DELAY AFTER A POWER SUPPLY ALARM HAS OCCURRED.**

---

Default is 10 minutes.

### C. Service

#### c. Wash Settings

##### Wash Settings 1

Pre-Soak:	180 sec
Detergent:	60 sec
Soak:	180 sec
Rinse:	240 sec
Dry:	60 min
Drain Time:	60 sec

The **Wash Settings** sub-menu allows the user to view and adjust the wash times.

---

**THIS SCREEN ALLOWS THE USER TO ADJUST SETTINGS FOR A UNIT WASH. DEFAULT TIMES ARE PROVIDED ON PAGE 12 OF THIS MANUAL.**

---

**Pre-Soak:** Time for spraying cell(s) with water.

**Detergent:** Time for spraying cell(s) with water with detergent injected into the water line.

**Soak:** Time to allow the cells to soak (water and detergent stop).

**Rinse:** Time for spraying the cell(s) with water to remove debris and detergent.

**Dry:** Time for turning on the fan after a wash to dry out the cells.

**Drain:** This time begins simultaneously with the dry time. During this drain time, the drain solenoid valve will open allowing any excess water in the main line to drain.



Wash Settings 2	
Auto Wash:	Yes
Auto Wash Time:	2:00am
Days/Week	
Mo Tu Wd Th Fr Sa Su	■ ■ □ ■ ■ ■ ■

Last Washes	
Last Complete Wash	00:00:00am 00/00/00
Last Aborted Wash	00:00:00am 00/00/00
Reason:	None

Wash Log History	
	Press ENTER key to access log history of completed washes.

Clear Wash Log History	
This will clear the wash log history.	
Continue? NO	

---

**THIS SCREEN ALLOWS THE USER TO ADJUST SETTINGS REGARDING THE AUTO WASH FEATURE WHICH STARTS A WASH AUTOMATICALLY AT A SPECIFIC TIME A DAY.**

---

**Auto Wash:** Enable or disable the auto wash feature.

**Auto Wash Time:** Adjust the time of day the wash will start. Note the wash will only begin if the fan is not on.

**Days/Week:** Adjust which days per week the auto wash should occur. Black (filled in) boxes indicate enabled for that day, white (open) boxes indicate disabled for that day.

---

**THIS SCREEN ALLOWS THE USER TO VIEW LAST COMPLETED SUCCESSFUL WASH CYCLE, LAST WASH CYCLE THAT WAS STOPPED SHORT, AND THE REASON WHY THE LAST WASH CYCLE WAS STOPPED SHORT.**

---

**Last Complete Wash:** Date and time stamp of last completed, successful wash cycle.

**Last Aborted Wash:** Date and time stamp when last wash cycle was stopped.

**Reason:** Reason for the last wash cycle stopping short OR prevented from starting. Reasons can include:

- Keypad Wash Bn – Wash button on keypad was pressed, stopping the wash cycle
- Open Unit Door – Door on unit body was left open or opened during the wash cycle
- Keypad Fan Run – Fan button on keypad was pressed before the wash cycle was attempted to start, or pressed while the wash cycle was in process, overriding the fan to turn on and therefore stopping the wash cycle
- DI Fan Run – Digital input (Fan On/Off, Digital Input 1) was detected as closed before wash cycle was attempted to start, or closed while the wash cycle was in process, overriding the fan to turn on and therefore stopping the wash cycle
- Program Change – If wash control is disabled in the factory settings, this will stop a wash from completing
- Fire Active – If kitchen fire is detected, it will prevent a wash from occurring or stop a wash from completing

---

**THIS SCREEN ALLOWS THE USER TO VIEW LAST COMPLETED SUCCESSFUL WASH CYCLES, PROVIDED WITH A DATE AND TIME STAMP.**

---

Pressing enter will bring up the successful wash log history. Pressing up/down arrows will cycle through each successful wash date/time stamp. The log only records successfully completed wash cycles. All aborted wash cycles will not be recorded.

NOTE
The log is capable of logging up to 100 washes. Once 100 is reached, the program will overwrite the oldest wash date/time stamp logged.

---

**THIS SCREEN ALLOWS USER TO CLEAR THE WASH LOG HISTORY. PRESSING ENTER TO NAVIGATE DOWN TO “No”, AND CHANGING TO “Yes” ON THIS SCREEN WILL CLEAR ALL RECORDED SUCCESSFUL WASH CYCLE DATE/TIME STAMPS.**

---

### Low Det Settings 1

Washes during low detergent alarm: 0  
Last wash on low det:  
00:00:00am 00/00/00  
Reset Det Count: OFF

### Low Det Settings 2

Det Alm Delay: 15s

### Wash Settings 3

ESP cell power supply delay time after wash cycle is aborted: 90 min

### Test Wash Setup

Pre-Soak:	10 sec
Detergent:	10 sec
Soak:	10 sec
Rinse:	10 sec
Dry:	1 min
Drain:	10 sec
Start Test Wash?	NO

## C. Service

### d. BMS Configuration

### BMS Configuration

Protocol: BACnet MSTP  
BACnet Plugin? YES

### MODBUS SETUP

Address: 1  
Baudrate 9600

---

**THIS SCREEN ALLOWS USER TO VIEW LOW DETERGENT INFORMATION RECORDED WITH WASH SYSTEM.**

---

**Washes during low detergent alarm:** Counts number of times wash cycle was completed during a low detergent alarm.

**Last wash on low detergent:** Date and time stamp when last wash cycle was stopped short OR prevented from starting.

**Reset detergent count:** Changing this from “OFF” to “ON” will change the count for “Washes during low detergent alarm” back to 0.

---

**THIS SCREEN ALLOWS THE USER TO ADJUST THE DELAY TIME TO INITIATE A LOW DETERGENT FAULT AFTER DETECTING NO DETERGENT FLOW.**

---

Default is 15 seconds.

---

**THIS SCREEN ALLOWS THE USER TO ADJUST THE DELAY TIME BEFORE CELLS CAN BE POWERED AGAIN IF A WASH CYCLE IS STOPPED PREMATURELY.**

---

Default setting is 90 minutes.

---

**THIS SCREEN ALLOWS THE USER TO ADJUST SETTINGS FOR A UNIT TEST WASH AND ALSO START A TEST WASH. TEST WASHES ALLOW FOR EXPEDITED SEQUENCE TIMES TO QUICKLY MONITOR A FULL WASH SEQUENCE. CHANGING “NO” TO “YES” WILL START A TEST WASH. DURING A TEST WASH, PRESS THE BACK BUTTON TO ABORT THE TEST WASH SEQUENCE.**

---

The **BMS Configuration** sub-menu allows the user to view and alter BMS protocol settings. If the BMS protocol is BACnet or Modbus, additional screens allow further configuration. See below for details. To access the **BMS Configuration** sub-menu, enter the service password (Default=1000).

---

**THIS SCREEN ALLOWS THE USER TO SELECT THE BMS PROTOCOL. ALL BMS PROTOCOLS REQUIRE A COMMUNICATIONS CARD INSTALLED IN THE SERIAL CARD PORT, LOCATED ON THE FACE OF THE CONTROLLER.**

---

If the protocol is BACnet MSTP or BACnet IP/Eth, the user can change common BACnet parameters via the controller. The BACnet Plugin must be set to YES.

---

**THIS SCREEN ALLOWS THE USER TO ADJUST MODBUS PARAMETERS.**

---

*This screen only appears if the selected BMS protocol is set to Modbus.*

The address is the Modbus address of the card installed in the SERIAL CARD port located on the face of the controller. (Factory Default = 1).

The Baud Rate should be set to the BMS baud rate. (Factory Default = 9600).

MSTP SETUP	
Instance:	77000
Baudrate	38400
MAC Addr:	0
MaxMasters:	127
MaxInfoFrames:	20

BACnet Read/Write	
Function:	Read
Update?	Yes
*Cycle unit power to confirm write command.	

TCP/IP SETUP	
Instance:	77000
IP set by:	DHCP
IP:	128.2.104.134
Subnet:	255.255.000.000
Gateway:	128.2.0.12

TCP/IP SETUP	
DNS 1:	192.168.001.001
DNS 2:	192.168.001.001
Type: IP	

BACnet Read/Write	
Function:	Read
Update?	Yes
*Cycle unit power to confirm write command.	

**THIS SCREEN ALLOWS THE USER TO ADJUST BACNET MSTP PARAMETERS.**

This screen only appears if the selected BMS protocol is set to BACnet MSTP and BACnet Plugin = YES.

If a BACnet MSTP card has been installed, the default parameters can be changed via the controller display. Factory settings are shown in the screen to the left.

To view current parameters:

1. Power on controller and allow several minutes to initialize.
2. Go to **BMS Configuration** menu and view BACnet Read/Write screen.
3. Change *Function* to *Read* and *Update?* to *YES*.

Current BACnet MSTP parameters should now be displayed in the BACnet MSTP SETUP screen. If all values appear to be zeros, consult the factory. (Make sure you have allowed several minutes for the controller to initialize).

*Values may appear to be zero prior to setting the Function to READ.*

To change BACnet MSTP parameters:

1. Power on controller and allow several minutes to initialize.
2. Go to **BMS Configuration** menu and view MSTP SETUP screen.
3. Move cursor to desired parameter by pressing the ↑ ↓ buttons. Press ← to select the parameter to change. Press the ↑ ↓ buttons to adjust the parameter. Press ← to save adjusted value.
4. Once desired parameters have been entered, go to BACnet Read/Write screen. Change *Function* to *Write* and *Update?* to *YES*.
5. Reboot the controller by cycling power to the unit. Allow several minutes for the controller to initialize.
6. View MSTP parameters. If changed values did not save, contact the factory.

**THIS SCREEN ALLOWS THE USER TO ADJUST BACNET IP PARAMETERS.**

This screen only appears if the selected BMS protocol is set to BACnet IP/Eth and BACnet Plugin = YES.

If a BACnet IP card has been installed, the default parameters can be changed via the controller display. **The card is in DHCP mode from the factory.** Once communication is established, the user can enter static IP parameters.

To view current parameters:

1. Power on controller and allow several minutes to initialize.
2. Go to **BMS Configuration** menu and view BACnet Read/Write screen.
3. Change *Function* to *Read* and *Update?* to *YES*.

Current BACnet IP parameters should now be displayed in the BACnet TCP/IP SETUP screen. If all values appear to be zeros, consult the factory. (Make sure you have allowed several minutes for the controller to initialize).

*\*Values may appear to be zero prior to setting the Function to READ.*

To change BACnet TCP/IP parameters:

1. Power on the controller and allow several minutes to initialize.
2. Go to **BMS Configuration** menu and view TCP/IP SETUP screen.
3. Move cursor to desired parameter by pressing the ↑ ↓ buttons. Press ← to select the parameter to change. Press the ↑ ↓ buttons to adjust the parameter. Press ← to save adjusted value.
4. Once desired parameters have been entered, go to BACnet Read/Write screen. Change *Function* to *Write* and *Update?* to *YES*.
5. Reboot the controller by cycling power to the unit. Allow several minutes for the controller to initialize.
6. View TCP/IP parameters. If changed values did not save, contact the factory.

## C. Service

- e. Service Settings
  - a. Fan Operation
  - b. I/O Manual Control
  - c. Sensor Calibration
  - d. User Save/Restore
  - e. Alarm History Reset

The **Service Settings** sub-menu allows the user to adjust fan operation settings, set a fan on/off schedule, manually enable/disable input and outputs, calibrate sensors, create or restore user settings and the alarm history log.

## C. Service

- e. Service Settings
  - a. Fan Operation

The **Fan Operation** sub-menu allows the user to adjust fan settings.

### Auto Fan Off Settings

Auto Fan Off? No  
Run Hours: 8 hours  
Note: This will only shut the fan off if the fan was powered on by the keypad (NOT DI)

**THIS SCREEN ALLOWS THE USER TO ADJUST SETTINGS REGARDING THE AUTO OFF FEATURE WHICH STOPS THE FAN IF STARTED FROM THE USER INTERFACE AFTER A SPECIFIC AMOUNT OF TIME.**

**Auto Fan Off?:** Enable or disable the auto fan off feature. (Default is No).

**Run Hours:** Adjust fan run time before the fan automatically shuts off. (Default = 8 hours).

### Fan Scheduling

Fan On: NO  
8:00am  
Fan Off: NO  
10:00pm  
Days/Week  
Mo Tu Wd Th Fr Sa Su  
■ ■ □ ■ ■ ■ ■

**THIS SCREEN ALLOWS THE USER TO SET A FAN ON/OFF SCHEDULE FOR THE WEEK.**

**Fan On:** Enable or disable the fan turning on at a specific time. Time can be adjusted below for fan on setting. (Default is NO, with 8:00am start time).

**Fan Off:** Enable or disable the fan turning off at a specific time. Time can be adjusted below for fan off setting. (Default is NO, with 10:00pm start time).

**Days/Week:** Adjust which days per week the auto wash should occur. Black (filled in) boxes indicate enabled for that day, white (open) boxes indicate disabled for that day.

## C. Service

- e. Service Settings
  - b. I/O Manual Control

In **I/O Manual Control**, the user will be able to adjust inputs/outputs.

**NOTE:** The manual adjustment of these input and/or outputs should only be adjusted in the event of troubleshooting. We suggest these parameters only be changed with the advice of factory personnel.

### Analog Input

PS1 Status (AIN 4)  
Manual Control B004:OFF  
Manual Position 0.0  
Value 2.50vdc

**Manual Control:** Allows the user to override the analog input for troubleshooting.

**Manual Position:** The value to force the input to when in an override state.

**Value:** The current value of the analog input.

### Digital Input

On / Off (DIN 1)  
Manual DI 1: OFF  
Manual Position: CLOSED  
DI 1 Status: Open

**Manual DI:** Allows the user to override the digital input for troubleshooting.

**Manual Position:** The value to force the input to when in an override state.

**Status:** The current value of the digital input.



Relay Output	
Exhaust Relay	(DOUT 1)
Manual Relay 1:	OFF
Manual Position	OFF
Relay 1 Status:	OFF

Analog Output 1	
Fan Speed	(AOUT 1)
Mode:	Auto
Manual Value	0.00vdc
Output:	0.00vdc

C.  Service	
e. Service Settings	
c. Sensor Calibration	

Analog Input	
Fan Speed (AIN1)	
Input B01	
Offset	0.0
Value	100.0

C.  Service	
e. Service Settings	
d. User Save/Restore	

User Save/Restore	
	
Save?	No
Restore?	No
Enable Auto Save:	Yes

C.  Service	
e. Service Settings	
e. Alarm History Reset	

Alarm History Reset	
This will clear the alarm history.	
Continue?	NO

**Manual Relay:** Allows the user to override the relay output for troubleshooting.

**Manual Position:** The value to force the output to when in an override state.

**Status:** The current value of the relay output.

**Mode:** Allows the user to override the analog output for troubleshooting.

**Manual Value:** The value to force the output to when in an override state.

**Output:** The current value of the analog output.

In **Sensor Calibration**, the user will be able to adjust analog inputs offsets.

**Offset:** This adjustable value can be used to calibrate the input with an offset value. (Factory Default = 0.0)

**Value:** This is the current value of the input. (Offset adjustment is added).

*Similar screens are available for the remaining analog inputs.*

In **User Save/Restore** mode, the user will be able to save and restore the default parameters stored in memory.

If the user would like to save their settings, move the cursor to the SAVE position and change to YES. This will save all of the current parameters into memory as Service Settings. If the user would like to restore to these values at some point in the future, moving the cursor to the RESTORE position and selecting ON, will restore the controller to the user-saved defaults.

---

**THIS SCREEN ALLOWS THE USER TO CLEAR THE ALARM FROM MEMORY.**

---

If the user would like to clear the alarm log, move the cursor to the OFF position and change to YES.

## D. Manufacturer

The **Manufacturer** menu allows the user to access several sub-menus regarding controller configuration, I/O configuration, factory settings, controller initialization pages, and factory save/restore pages. These changes are to be completed under factory advisement only!

## Keypad Navigation

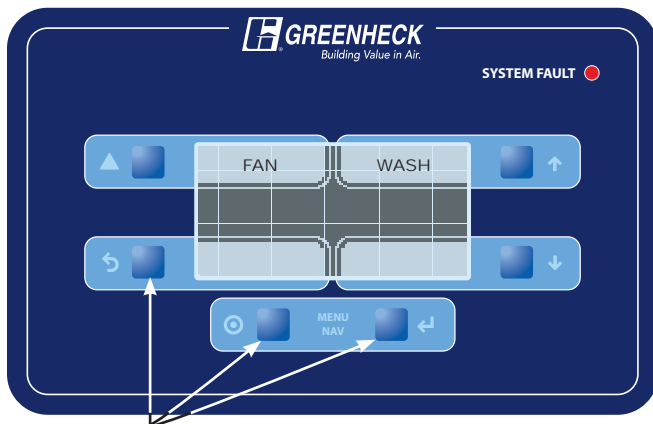

When '**BUTTON(S)**' are mentioned in the description below, we are referring to the 'squares' on the keypad. The following information details the Daily Operations of the Grease Trapper ESP keypad buttons and their functions.

**FAN** - Momentarily pressing the 'FAN' button will turn on the PCU unit. If the fan is on, the background behind 'FAN' text will be dark. To turn the system off, press the 'FAN' button.

**WASH** - Momentarily pressing the 'WASH' button will start the automatic washdown sequence. If the wash sequence is in process, the background behind 'WASH' text will be dark. To cancel the wash sequence, press the 'WASH' button.

**MORE, if equipped** - Momentarily pressing the 'MORE' button will navigate to an additional screen

**BACK, if equipped** - Momentarily pressing 'BACK' button will navigate to the previous screen.

### Display functionality and control:

To change the display contrast, hold the buttons next to the Alarm ⚠ and Program Ⓞ icons simultaneously while pressing the buttons next to the ↓ and ↑ arrows. The down arrow will make the screen lighter and the up arrow will make the screen darker.

Upon any alarm, the 'SYSTEM FAULT' red LED light on the face of the keypad starts flashing. Once all alarms are corrected and any low detergent alarm is manually reset, this LED will stop flashing and no longer be illuminated.

Through the middle of the screen, system status messages will be displayed as a reference. These system statuses will include:

- Current alarms
- Power Supply Status
- Exhaust Fan Status
- Wash Sequence

The keypad also includes indicators next to the buttons that correspond to the buttons on the controller. These can be used to navigate through the controller using the keypad. To access the main menu, simply press and hold the button next to the Program Ⓞ icon for **five seconds** or until the screen changes to the main menu.

# Touch Screen Navigation



**Momentarily press or tap to access the menu or enable or disable the action of the associated icon. All icons surrounded by blue are momentary push buttons.**



**FAN ON/OFF** - turns the unit on and off. When the unit is in operation, the fans in the icon will spin indicating the unit is operating. Tapping the icon again will cause the unit to turn off.



**WASH OFF** - starts or stops the wash sequence. Pressing the button will begin the automated wash sequence to clean the unit. Tapping the icon again will abort the wash sequence.



**DETERGENT INDICATOR** - monitors the detergent level in the detergent tank and flow of the detergent pump. Green will indicate there is sufficient detergent in the tank. When the detergent alarm is active, the icon will display low across it. Refill the tank or check detergent lines for blockages as needed to remove low detergent alarm.



**FAN STATUS INDICATOR** – green is normal operation and red indicates an alarm or the fan is stopped.



**POWER SUPPLY STATUS INDICATOR** - green indicates power supply is on and red indicates the power supply is off or in a fault condition. If the power supply is being delayed on due to a wash cycle being stopped short, a count down timer associated with this delay will appear above this icon indicating “PS ON DELAY”



**DOOR SAFETY STATUS INDICATOR** – green is normal operation.



**WASH STATUS INDICATOR** – green indicates normal operation.



**FIRE STATUS INDICATOR** – green indicates normal operation and red indicates a fire has been detected.



**HELP** – displays a help menu and navigation tips.



**ESP WASH STATUS** - navigates to a screen showing wash status and countdown timers.

**ESP Wash Status Indicators:** As the system is in the wash mode, the indicators will change colors based on the state of washing. Green indicates the mode of operation.

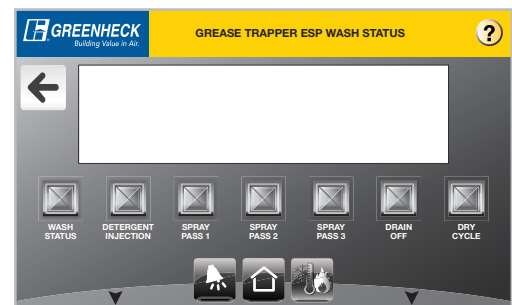

**NAVIGATION BAR** – pulls up a hidden menu allowing access to alarms, home, and settings/configuration/information screens. This is available on every screen.



The alarm icon directs you to the alarms screen. **This icon will illuminate red and blink when an alarm has been triggered.**

The middle icon directs you to the home screen.

The icon on the far right allows navigation to the settings/configuration/information menu screen.

Pressing either of the black arrows to the right and left of these three buttons will hide the navigation menu bar.

## Service Password Screen

### NOTE

The Service Password must be entered to access the SETTINGS, CONFIGURATION and INFORMATION screen. The default service password is 1000.

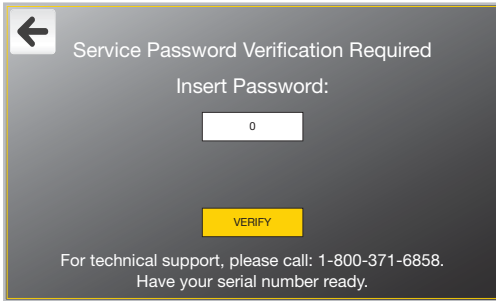

## Active Alarms Example

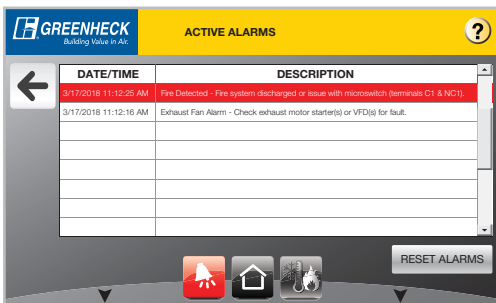

## General Information

Any field surrounded by a box with a white fill indicates that it is editable.

If an editable field displays a numerical value and the user taps the field, a number keypad will display. After entering the desired value, press the Enter button.

If the editable field is an alphanumeric value, a standard keyboard will display. After entering the desired value, press the Enter button.

The field may also display a multiple choice ON/OFF, or a checkmark box. For the ON/OFF fields, press the box opposite of the checked box to change the option from either OFF to ON or visa versa.

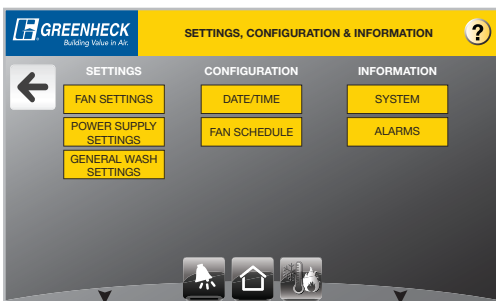

## Settings

### • Fan Settings

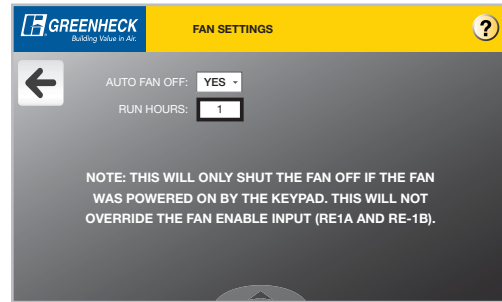

**Auto Fan Off:** Enable or disable the auto fan off feature.

**Run Hours:** Adjust fan run time before the fan automatically shuts off.

### • Power Supply Settings

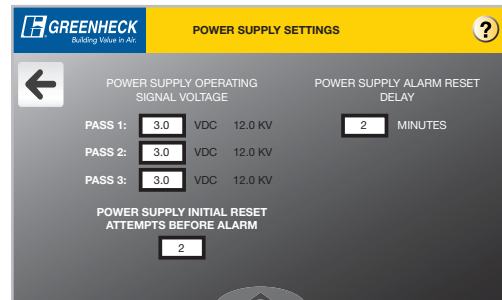

**Power Supply Operating Signal Voltage:** Adjustable output signal power to power supplies and the corresponding kV output.

**Power Supply Initial Reset Attempts before Alarm:** Adjustable power supply reset attempts upon a fault before entering an alarm for the power supplies.

**Power Supply Alarm Reset Delay:** Adjustable time delay after a power supply alarm has occurred in which the system attempts to retry the power supplies.

### • General Wash Settings

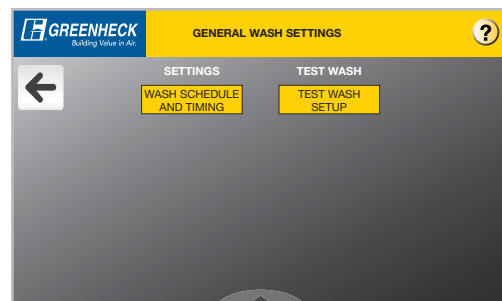

Navigating to the Wash Schedule and Timing screen will allow the user to adjust the auto wash settings and the timing sequences within the wash cycle. Navigating to the Test Wash Setup screen will allow the user to adjust test wash timing sequences and start a test wash.



## • Wash Schedule and Timing Settings

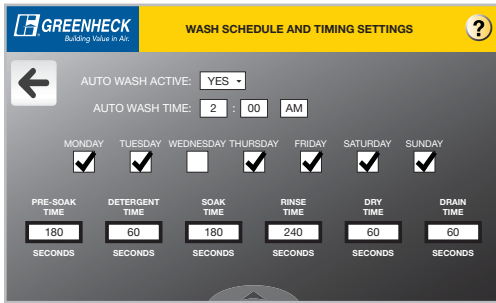

**Auto Wash Active:** Enable or disable the auto wash feature.

**Auto Wash Time:** Adjust the time of day the wash will start. Note the wash will only begin if the fan is not on.

**Days/Week:** Adjust which days per week the auto wash should occur. Boxes with check marks indicate enabled for that day, white boxes without check marks indicate disabled for that day.

**Wash Sequence Timers:** The times for the various wash sequences can be adjusted as needed based on site conditions. To adjust the time press the white area that contain the numbers. A pop-up window will open with a keypad to allow adjustment to the start time.

## • Test Wash Setup

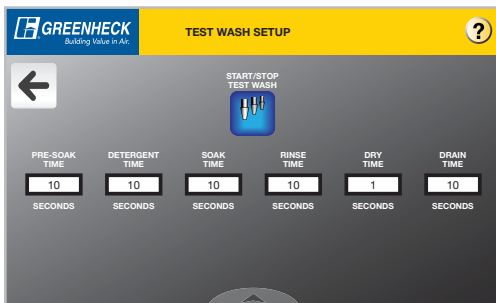

Press the “START/STOP TEST WASH” button to start or stop a test wash.

**Test Wash Sequence Timers:** The times for the various wash sequences can be adjusted as needed for the test wash cycle. To adjust the time press the white area that contain the numbers. A pop-up window will open with a keypad to allow adjustment to the start time.

## Configuration

### • Date/Time

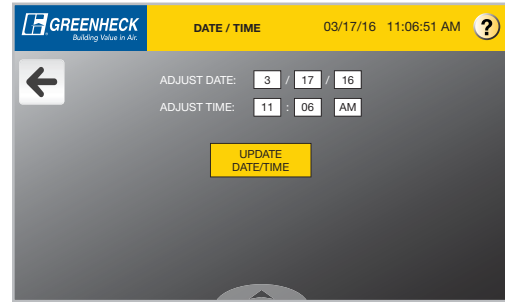

**Adjust Date:** Adjust the date. DD/MM/YY format.

**Adjust Time:** Adjust the time.

To store the adjusted date and time in both the touch screen and the main controller, press “UPDATE DATE/TIME”.

### • Fan Schedule

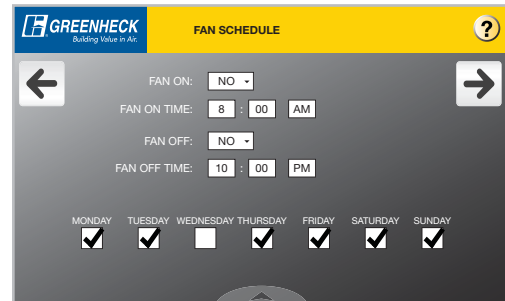

**Fan On:** Enable or disable the fan turning on at a specific time.

**Fan On Time:** Time during the day when fan will turn on.

**Fan Off:** Enable or disable the fan turning off at a specific time.

**Fan Off Time:** Time during the day when the fan will turn off.

**Days/Week:** Adjust which days per week the auto wash should occur. Boxes with check marks indicate enabled for that day, white boxes without check marks indicate disabled for that day.

## Information

### • System Information



Displays important system information including firmware and software versions.

### • Alarms

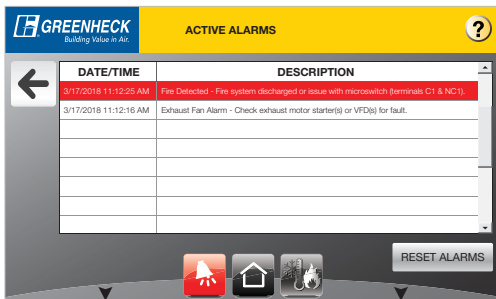

This screen will display all current alarms. In the event of an alarm, the alarm screen will automatically be displayed. The alarm description, date and time are provided for each fault. If no faults exist, 'No Active Alarms' will be displayed. Once a fault is corrected, all alarms will automatically cleared EXCEPT for the low detergent alarm. The low detergent alarm needs to be manually reset by pressing the 'RESET ALARMS' button.

## Variable Frequency Drive (VFD) Information

A Yaskawa V1000 (200-230 VAC and 460 VAC) or Yaskawa A1000 (575 VAC) variable frequency drives (VFDs) will be provided if the PCU is configured to use a VFD to control the exhaust fans. These drives will come programmed from the factory, and little to no adjustment will be necessary in most cases. For more in-depth information on wiring and programming these drives, please utilize the Quick Start Guide provided with the package. This quick start guide and other technical manuals can also be found on the Yaskawa website at [www.yaskawa.com](http://www.yaskawa.com).



Parameter	Description	Default Value	Factory Adjustment
<b>b1-07</b>	LOCAL/REMOTE Run Selection	00	01
<b>b1-17</b>	Run Command at Power Up	00	01
<b>C1-01</b>	Acceleration Time 1	10.00 seconds	30.00 seconds
<b>C1-02</b>	Deceleration Time 1	10.00 seconds	30.00 seconds
<b>E1-01</b>	Input Voltage	Dependent on drive type	Dependent on motor voltage*
<b>E2-01</b>	Motor Rated Current	Dependent on drive type	Dependent on motor FLA (full load amperage)*
<b>L2-01</b>	Momentary Power Loss Operation Selection	00	02
<b>L5-01</b>	Number of Auto Restart Attempts	00	10

\*See PCU wiring diagram for more information.

### Resetting the VFD Faults

Upon a VFD fault, first determine the cause of the fault and correct. Typically, if the drive detects a fault, it will remain inoperable until that fault has been corrected and the drive has been reset.

Once a fault has been corrected, the easiest way to clear the displayed fault on the VFD is to shut off power to the drive from the power source (breaker). Wait for the VFD to fully discharge and then restore the power.

Upon correcting a minor fault, recycling power may not be necessary. Simply press , then press  twice.

# Model V1000

## Changing Parameters

**Step 1:** V1000 Digital Operator power-up state.

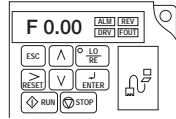

### Step 2: Select Parameter Menu

Press **[V]** two times until the digital operator show the parameter menu (PAr) then press **[ENTER]**.

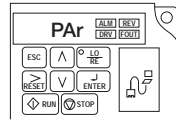

### Step 3: Select Parameter

Press **[RESET]** to select the digit you would like to change. Next use **[^]** and **[V]** to select the parameter group, sub-group or number.

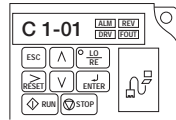

Once the parameter you wish to change is displayed on the screen and the digit furthest to the right is flashing, press **[ENTER]**.

### Step 4: Change Parameter Value

Press **[RESET]** to select the digit of the parameter value you would like to change.

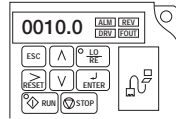

Modify the parameter value using **[^]** and **[V]** and press **[ENTER]** to save the new value.

## Monitor Motor Frequency and Motor Current

**Step 1:** V1000 Digital Operator power-up state:

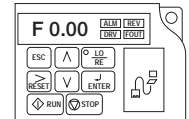

### Step 2: Output Frequency

Press **[^]** until the **FOUT** LED turns on. The display now shows the actual drive output frequency in hertz (Hz).

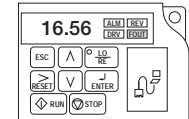

### Step 3: Motor Current

Press **[^]** again will show the motor output current. The 'A' behind the value means 'Amps'.

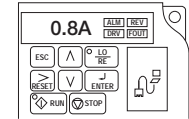

# Model A1000

## Changing Parameters

**Step 1:** A1000 Digital Operator power-up state.

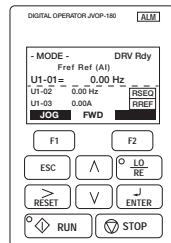

### Step 4: Change Parameter Value

Press **[RESET]** to select the digit of the parameter value you would like to change.

Modify the parameter value using **[^]** and **[V]** and press **[ENTER]** to save the new value.

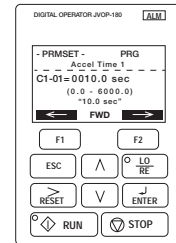

### Step 2: Select Parameter Menu

Press **[V]** two times until the digital operator shows the programming menu, then press **[ENTER]**.

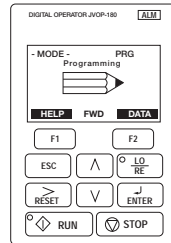

## Monitor Motor Frequency and Motor Current

With the drive running, press **[^]** until reaching the Monitor Menu. This will display output frequency and amperage of the motor.

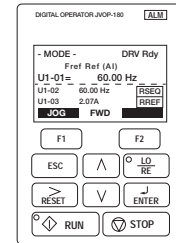

### Step 3: Select Parameter

Press **[RESET]** to select the digit you would like to change. Next use **[^]** and **[V]** to select the parameter group, sub-group or number.

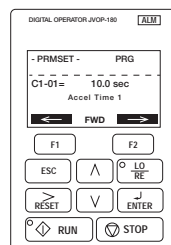

One the parameter you wish to change is displayed on the screen and the digit furthest to the right is flashing, press **[ENTER]**.



## BMS Points List • Grease Trapper ESP v1.00 Modbus / BACnet®

Type	BACnet Device Instance: 77000 (default) Analog = AV, Integer = AV, Digital = BV				Modbus - RTU/TCP Address: 1 (default)	Read Write	Description
	Instance	Name	Units				
Analog	20	Exhaust_Fan_Speed	percent		40021	R	Exhaust Fan Speed Percentage
			Inactive Text	Active Text			
Digital	101	Remote_Enable	Off	On	10102	R/W	Remote Fan Enable (0: Off; 1: On)
Digital	102	Fire_Status	Off	On	10103	R	Fire System Status (0: Ok; 1: Fire)
Digital	103	Wash_Enable	Off	On	10104	R/W	Wash Enable (0: Off; 1: On)
Digital	104	Detergent_Low	Off	On	10105	R	Detergent Status (0: Ok; 1: Empty)
Digital	105	Exhaust_Fan_Fault	Off	On	10106	R	Exhaust Fan Fault
Digital	106	Door_Switches	Off	On	10107	R	Door Interlock Switches (1: Ok; 0: Door Open)
Digital	130	Exhaust_Active	Off	On	10108	R	Exhaust Fan Status (0: Off; 1: On)
Digital	131	Pass1_Power_Supply	Off	On	10109	R	Power Supply Pass 1 Status (0: Off; 1: On)
Digital	132	Pass2_Power_Supply	Off	On	10132	R	Power Supply Pass 2 Status (0: Off; 1: On)
Digital	133	Pass3_Power_Supply	Off	On	10133	R	Power Supply Pass 3 Status (0: Off; 1: On)
Digital	134	Wash_Sequence_Active	Off	On	10134	R	Wash Status (0: Off; 1: Wash Cycle Active)



# Maintenance

## NOTE

Maintenance frequency will vary based on site conditions. Adjust frequency as needed.

## NOTE

It is recommended to visually inspect the cells at least once a week for the first month of the unit operation. Increase or decrease the wash times based on how clean the cells are upon inspection.

Routine service is required in order to ensure optimum performance and reliability of the system.

**Impingement and Mist Eliminator Filters:** These metal filters should be removed and thoroughly cleaned at a minimum of two (2) week intervals, removing any grease and particulate buildup.

**Ionizing-Collecting Cells:** The ionizing-collecting cells should be inspected for grease build-up on a monthly basis. This monthly inspection should be done after the system has completed a wash cycle. If grease build-up is apparent, remove cells and clean manually. The cells should be removed and manually cleaned every 6 months minimum.

**Carbon Trays:** Carbon tray changeout frequency is dependent on volume of cooking. Replace when an increase in odor breakthrough is first noticed. Change out should range between 3 and 6 months for typical cooking applications. Change out may be more frequent for heavy grease applications.

If opting to refill carbon trays instead of replacing them, follow the below steps:

1. Locate and remove fastener on 2-inch prefilled carbon tray.
2. Slide the filter tray top out of the filter.
3. Remove the old charcoal, and replace.
4. Replace tray top and fastener.

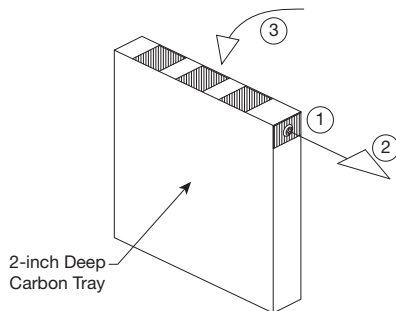

add timer be increased, the detergent flow control valve adjusted, or the detergent strength increased. Zep X701 should also be used to manually clean the impingement and mist eliminator filters. Substituting other types of detergent may result in decreased system performance, system shut down and voiding of the unit warranty.

To access the impingement and mist eliminator filters and ESP cells, follow these instructions.

1. Turn fan off using keypad.
2. Turn terminal box switch to “Off” to remove residual charge from cells. The indicating lights should turn off indicating power has been removed from the power supply. Follow all applicable lock and tag-out procedures to safely “Lock Out” the system to avoid potential injury.
3. Remove fasteners from door and open the access door to the filters.
4. Short the cells to ground to ensure any residual charge is removed before handling the cells.
5. Slide the metal mesh filters from the tracks.
6. Thoroughly clean the metal mesh filters using hot water and a Zep X701 detergent solution.
7. Reinstall the filters in the tracks.
8. Remove the door fasteners to access ESP cells.
9. Carefully remove cells from the module. Each cell weighs approximately 35 lbs.; use caution when handling. Use care not to bend or dent the collecting plates or framework.
10. Carefully inspect the cell for bent collector plates. Bent plates may be carefully straightened by hand, using needle-nose pliers.
11. Inspect the cell for residual grease that was not removed during the wash process. Excessive grease buildup indicates that wash times may need to be increased on the units. For excessive build-up the cells may need to be removed from the cabinet and manually cleaned.
12. Reinstall the cell to the location from which it was removed. There is an airflow arrow on the cell end plate.
13. Close the access door completely to ensure the door limit switches are closed and install the door fasteners.

## NOTE

Torque bolts to 60-70 in-lbs. Do not over torque. First, start threading bolts by hand to prevent cross-threading.

# Maintenance

## Replacement Parts Ordering

Replacement parts can be obtained through the Parts Department, 800-355-5354 or your local authorized Greenheck Sales Representative. To locate your local Representative, visit [greenheck.com](http://greenheck.com)

Description	Part Number
Hex Cap Bolts for ESP Module Doors (5/16 inch - 18 x 2.25 inch SS)	417307
Hex Cap Bolts for Impingement and Carbon Module Doors (5/16 inch - 18 x 1.5 inch SS)	417187
Washers for All Module Doors	417209
Green Indicator Light for Terminal Enclosure	386276
Red Indicator Light for Terminal Enclosure	386277
Auto Cell Discharge Contactor	383758
Auto Cell Discharge Resistor	386232
Auto Cell Discharge Resistor Mount	386233
Main Control Panel Fuse, 3A	380750
Main Control Panel Fuse, 20A	380341
Main Control Panel Fuse, 30A	380295
Main Control Panel Fuse Block	385762
Main Control Panel Fuse Block Cover	384006

20 x 20 x 1-inch Impingement Filter	913732
ESP Cell, left side door*	879791
ESP Cell, right side door*	879792
20 x 20 x 1-inch Mist Eliminator Filter	482432
20 x 20 x 2-inch Pre-Filled Carbon Tray	483439
Power Supply	386230
ESP Feed Thru Pin for Power Pack	386160
Plastic Isolator for ESP Cell	386224
5 Gallon Container of Detergent	HAZ2882
1/2 HP 1PH TEFC Detergent Pump Motor	329331

\*Door access is determined by standing at unit inlet with air hitting you in back.

## Unit Layout - Elevation Views

### STANDARD UNIT

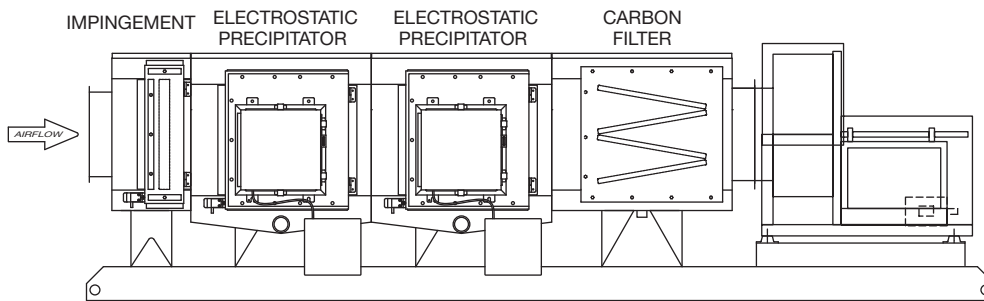

### SOLID FUEL UNIT

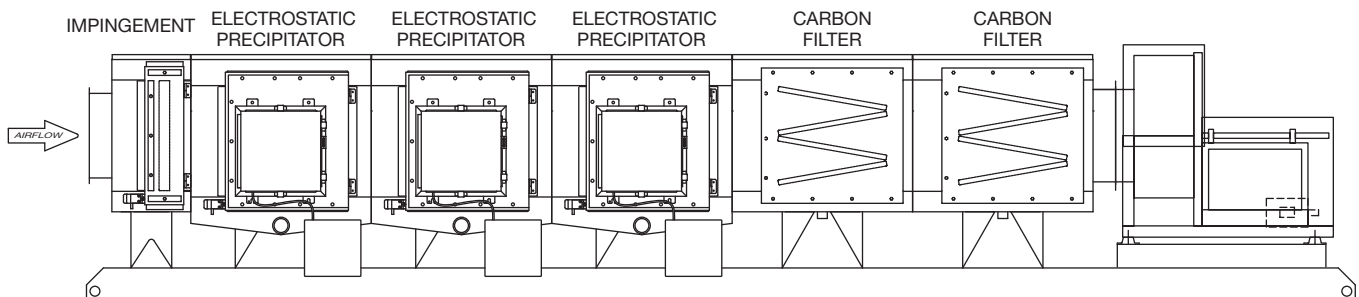

# Field Wiring Diagrams

Field diagrams are provided as general drawings. For unit specific drawings, consult wiring diagrams found on the unit control panels.

## STANDARD UNIT

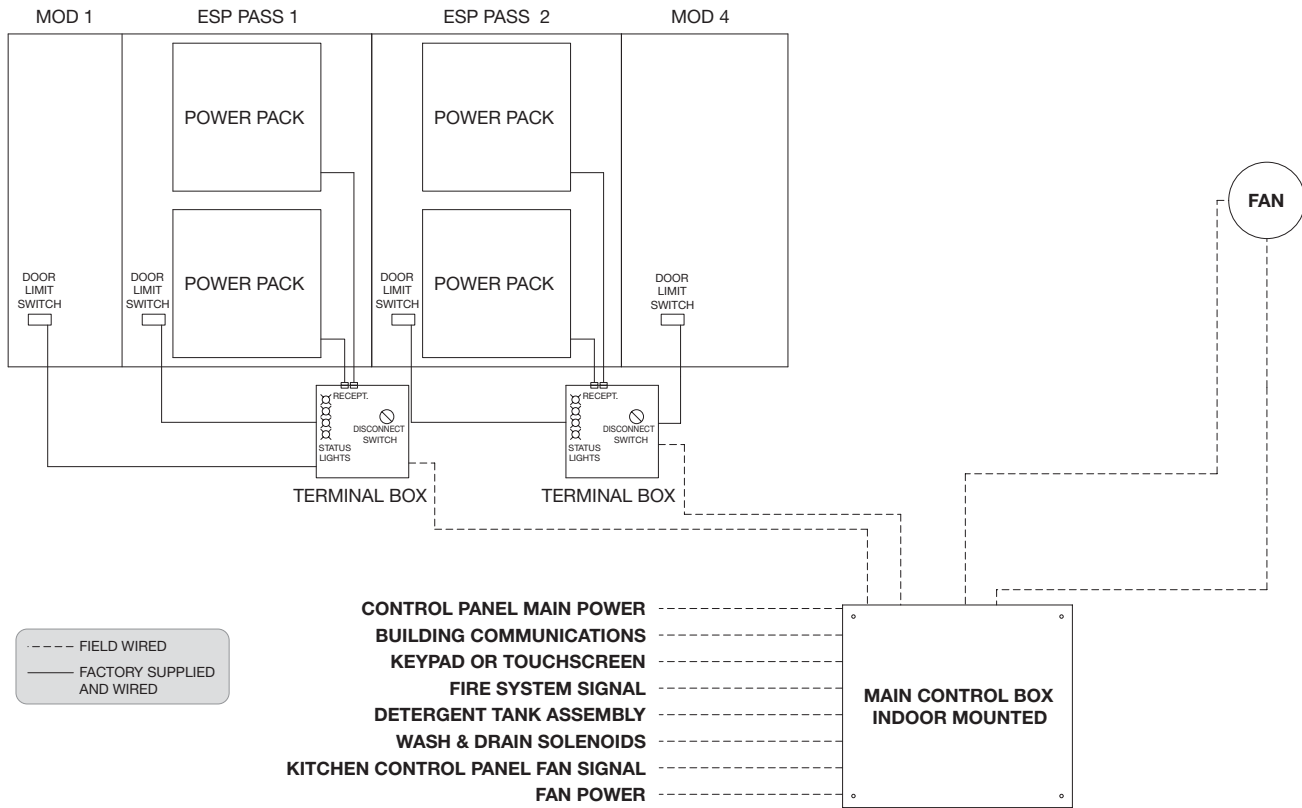

## SOLID FUEL UNIT

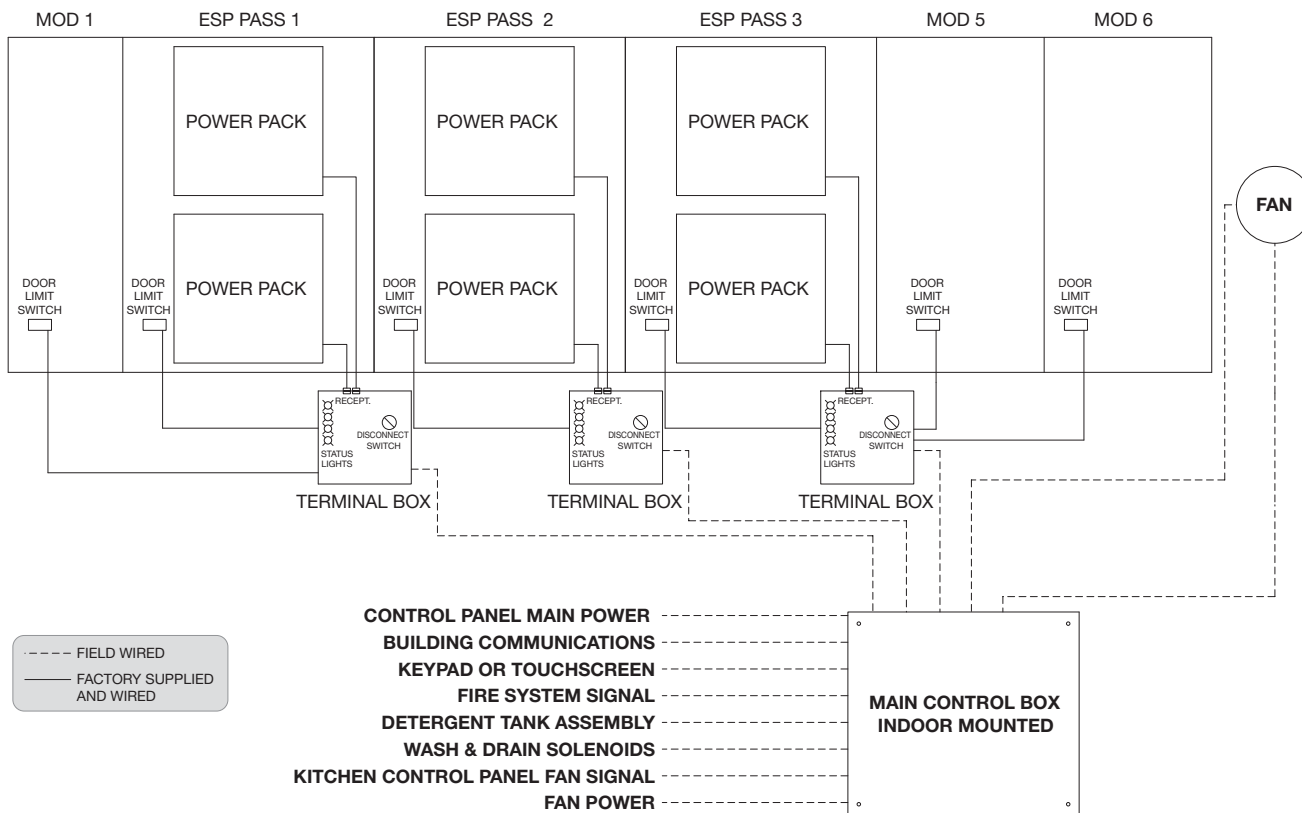

## FIRE SYSTEM CABINET WIRING OUTDOOR

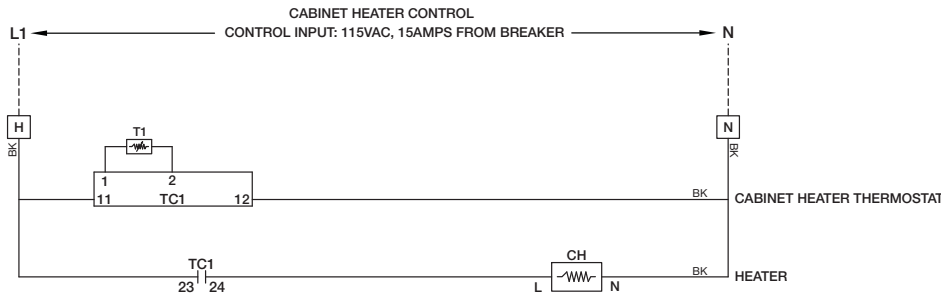

## THERMOSTAT PROGRAMMING INSTRUCTIONS

PARAMETER	SETTING	DESCRIPTION
S11	40.0	Setpoint Value Probe 1
S12	3.0	Setpoint Value Probe 2
S13	3.0	Setpoint Value Probe 3
r01	5.0	Differential Probe 1
r02	1.0	Differential Probe 2
r03	1.0	Differential Probe 3
r4	-50.0	Minimum Setpoint Value
r5	150.0	Maximum Setpoint Value
c01	inu	Mode Probe 1
c02	inu	Mode Probe 2
c03	inu	Mode Probe 3
c11	0.0	Minimum Output 1 Stop Time
c12	0.0	Minimum Output 2 Stop Time
c13	0.0	Minimum Output 3 Stop Time
c21	5.0	Minimum Output 1 On Time
c22	0.0	Minimum Output 2 On Time
c23	0.0	Minimum Output 3 On Time
c31	10.0	On Time Fault Probe 1 Cycle
c32	0.0	On Time Fault Probe 2 Cycle
c33	0.0	On Time Fault Probe 3 Cycle
c41	0.0	Off Time Fault Probe 1 Cycle
c42	0.0	Off Time Fault Probe 2 Cycle
c43	0.0	Off Time Fault Probe 3 Cycle
PO	F	Temp Scale
P11	0.0	Probe 1 Calibration
P12	0.0	Probe 2 Calibration
P13	0.0	Probe 3 Calibration
P2	YES	Decimal Point
P31	YES	Probe 1 Present
P32	NO	Probe 2 Present
P33	NO	Probe 3 Present
H2	NO	Keypad Protection
H4	0	Serial Communications Address
H5	0	Keypad Code
H6	Pt1	Type of Probe

### PARAMETER PROGRAMMING

- Press and hold Set for 30 seconds or until 00 appears blinking
- Press Set key to enter parameter list
- With ▲ and ▼ go to the desired parameter on the list of parameters
- Press Set to see the current set value
- Press either ▲ or ▼ to set the desired new value
- Press Set to confirm it and exit to the parameter list
- Press Set plus ▼ to quit programming or wait 1 minute (keyboard timeout).

### TORQUE:

TERMINAL BLOCKS = 8 LB.IN  
GROUNDING BLOCKS = 8 LB.IN

### FIELD WIRING:

USE MINIMUM  
60° Copper Wire

————— FACTORY WIRING

----- FIELD WIRING

LABEL	DESCRIPTION	WIRE COLOR
TC1	Dwyer Controller	BK - black
T1	PT1000 Temperature Sensor	BL - blue
VFD	Variable Frequency Drive	BR - brown
CH	Cabinet Heater (250 Watts)	OR - orange
DS1	Disconnect	PR - purple
PS#	Pressure Switch	RD - red
LT#	Status Light	YW - yellow
FS1	Fire System Microswitch 1	WH - white
FS2	Fire System Microswitch 2	

## FIRE SYSTEM WIRING - ANSUL ELECTRIC RELEASE

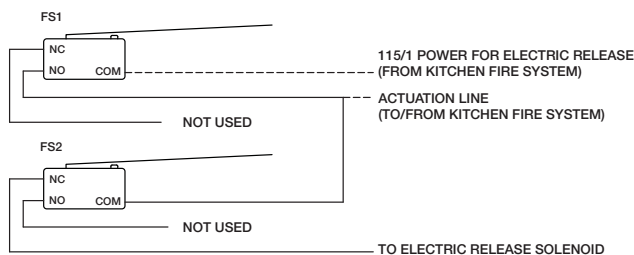

# Wash Water Plumbing Schematic (not to scale)

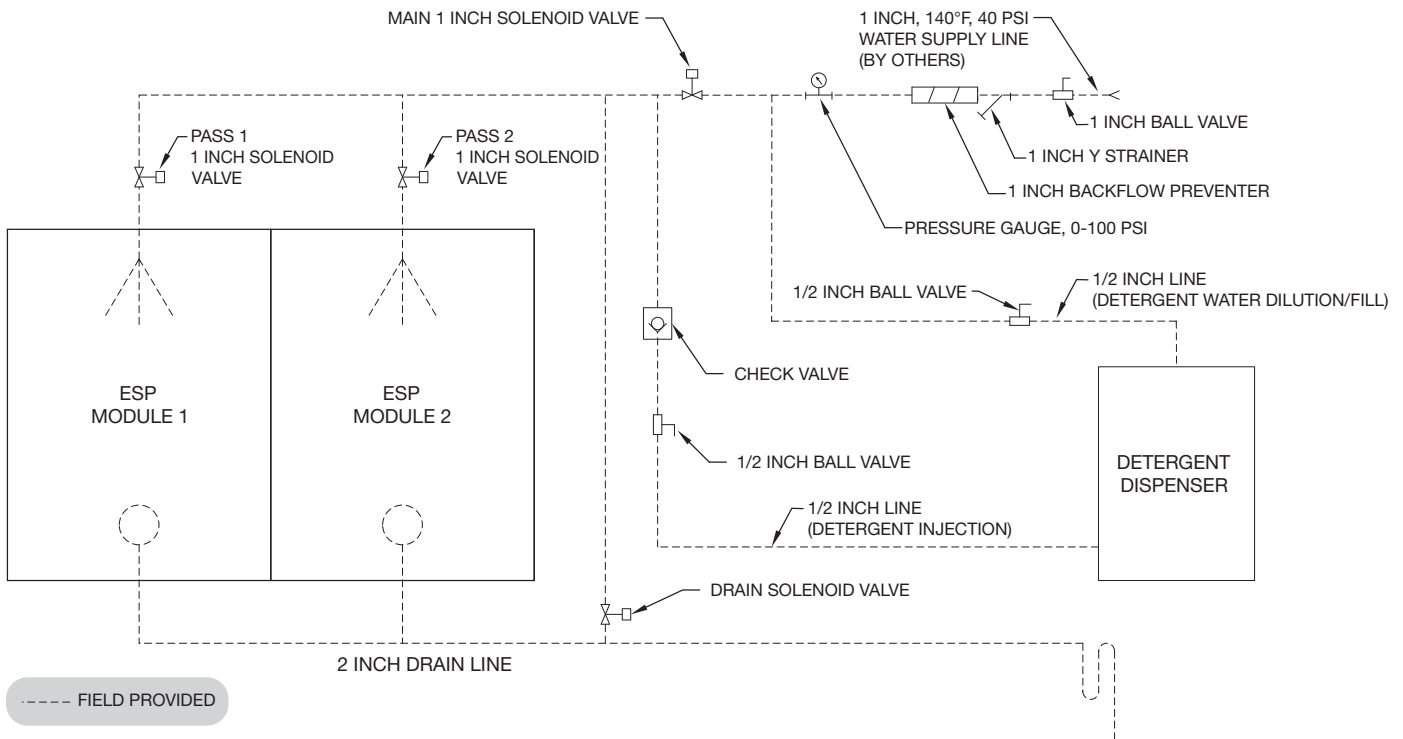

## Plumbing Notes:

1. Trapped drain line water column to be sized for total system loss + 1.0 in. wg  
Drain shall be plumbed to an approved grease interceptor.
2. Water supply and drain piping exposed to freezing must be trace heated and insulated.
3. All piping, backflow preventer, pressure gauges, ball valves and solenoid valves (24 VAC) are provided by others.
4. All solenoid valves provided in the field shall be equipped for outdoor or indoor environment, based on whether the unit is mounted indoors or outdoors.

## DETERGENT DISPENSER ASSEMBLY

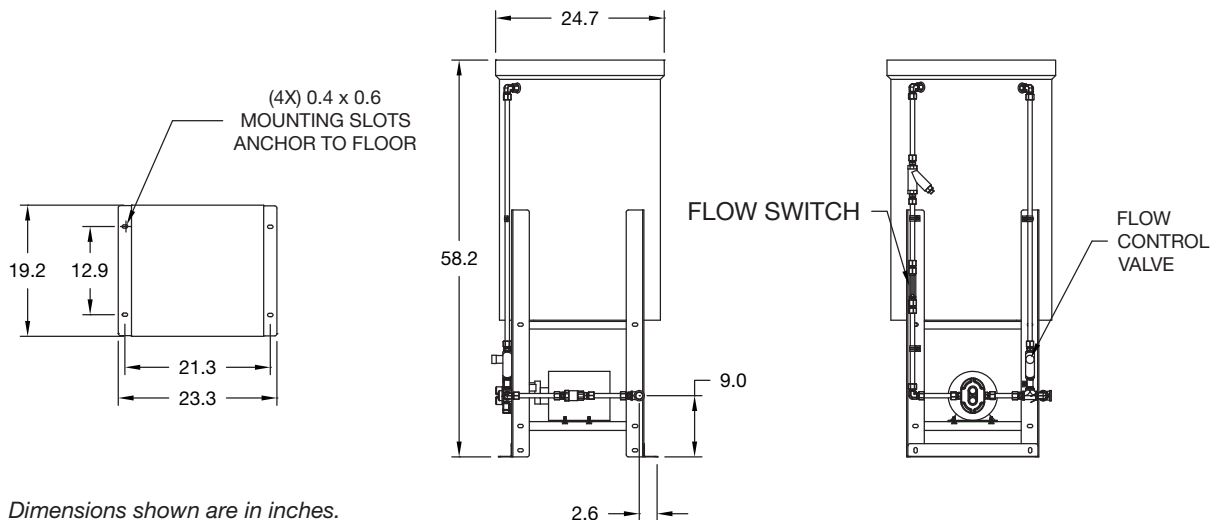

## Detergent Dispenser Notes:

1. Detergent dispenser must be located indoors in a freeze proof area.  
These components must also be located in an area convenient for monitoring/servicing.
2. Reservoir shall be polypropylene with removable lid.
3. Maximum allowable horizontal distance from detergent pump to unit = 10 feet.
4. Maximum allowable vertical distance from detergent pump to unit = 10 feet.



# Troubleshooting

<b>Problem:</b> Cells shorting immediately (red terminal enclosure light illuminating) and power supplies never reset	
Cells are dirty/clogged	Run through a wash, making sure detergent level is full. If cells are still dirty, safely removing cells and manual cleaning/spraying may be necessary. If air compressor is available on site, spray out cells thoroughly of any dust and debris.
Cells are not installed correctly	Safely remove cells and make sure they are installed correctly, see page 7.
High voltage cables are flip-flopped	Confirm high voltage cable polarity is correct (from power supplies to unit pins). Pink cable plugged into the port on the power supply labeled 'IONIZER' should connect to the pin labeled 'IONIZER', and pink cable plugged into the port on the power supply labeled 'COLLECTOR' should connect to the pin labeled 'COLLECTOR'.
Dry portion of wash cycle was bypassed	If the unit dry portion of the wash cycle was bypassed, the cells may still be wet. Run the fan for 60 – 90 minutes to dry out the cells.
<b>Problem:</b> When running unit, green indicator on terminal enclosure illuminates, then after a few seconds turns off, then repeats	
Power supply is not providing correct voltage back to control panel	Possible faulty or incorrectly programmed power supply. Contact factory for further troubleshooting assistance.
<b>Problem:</b> Indicator lights (LEDs) on terminal enclosures not illuminating	
Wiring not matching polarity of LEDs	Switch the leads on the LEDs located on the cover of the terminal enclosure(s).
Disconnects not on	Turn on disconnects on terminal enclosures
Faulty LEDs or faulty power supply	Test voltage to LEDs and to input power of power supply when unit is on. Replace LEDs/power supply if faulty.
<b>Problem:</b> Power supplies operating (green), but cells don't appear to be collecting contaminants	
Feed thru pins aren't coming into contact with cells	Make sure cells are installed per instructions on page 7, make sure back-stops are adjusted so last cell installed is 4 inches away from edge of unit frame
<b>Problem:</b> Cells not fully clean after completed wash cycle	
Detergent empty	Check to see if there is a low detergent alarm, refill detergent if empty
Incorrect detergent used	Make sure detergent used is the recommended Zep X701
Wash sequences are too short for cooking duty	Increase wash sequence times
Water temperature or pressure incorrect	Make sure water temperature is 140°F and 40 psi
<b>Problem:</b> Wash cycle won't start via button, digital input, nor the wash scheduler	
Fans are running	Fans need to be turned off before wash can be started
System in fire mode	Check for fire micro-switch wiring (normally-closed contact between C1 and NC1).
Wash cycle is starting, but water isn't turned on to unit	Confirm wash is running by referencing keypad/touchscreen. Check hot water shut off valves feeding the unit.
<b>Problem:</b> Unit not washing	
Something is preventing the wash from occurring	Review wash history pages on controller, see page 17-18 for more details.

## Maintenance Log

Date \_\_\_\_\_ Time \_\_\_\_\_ AM/PM

Notes: \_\_\_\_\_

\_\_\_\_\_

\_\_\_\_\_

\_\_\_\_\_

Date \_\_\_\_\_ Time \_\_\_\_\_ AM/PM

Notes: \_\_\_\_\_

\_\_\_\_\_

\_\_\_\_\_

\_\_\_\_\_

Date \_\_\_\_\_ Time \_\_\_\_\_ AM/PM

Notes: \_\_\_\_\_

\_\_\_\_\_

\_\_\_\_\_

\_\_\_\_\_

Date \_\_\_\_\_ Time \_\_\_\_\_ AM/PM

Notes: \_\_\_\_\_

\_\_\_\_\_

\_\_\_\_\_

\_\_\_\_\_

Date \_\_\_\_\_ Time \_\_\_\_\_ AM/PM

Notes: \_\_\_\_\_

\_\_\_\_\_

\_\_\_\_\_

\_\_\_\_\_

Date \_\_\_\_\_ Time \_\_\_\_\_ AM/PM

Notes: \_\_\_\_\_

\_\_\_\_\_

\_\_\_\_\_

\_\_\_\_\_

Date \_\_\_\_\_ Time \_\_\_\_\_ AM/PM

Notes: \_\_\_\_\_

\_\_\_\_\_

\_\_\_\_\_

\_\_\_\_\_

Date \_\_\_\_\_ Time \_\_\_\_\_ AM/PM

Notes: \_\_\_\_\_

\_\_\_\_\_

\_\_\_\_\_

\_\_\_\_\_

## Our Commitment

*As a result of our commitment to continuous improvement, Greenheck reserves the right to change specifications without notice.*

Product warranties can be found online at [Greenheck.com](http://Greenheck.com), either on the specific product page or in the literature section of the website at [Greenheck.com/Resources/Library/Literature](http://Greenheck.com/Resources/Library/Literature).

Greenheck's Grease Trapper ESP™ Pollution Control Unit catalog provides additional information describing the equipment and available accessories.

AMCA Publication 410-96, Safety Practices for Users and Installers of Industrial and Commercial Fans, provides additional safety information. This publication can be obtained from AMCA International, Inc. at [www.amca.org](http://www.amca.org).

